

REKLAMNÉ PREDMETY

60.000 druhov, 70% do dvoch dní
www.vyberdarcek.sk

2018

7



INDEX



2



372

Writing	2 - 71
Time and Electronics	72 - 85
Technology	86 - 147
Home	148 - 207
Rain	208 - 233
Personal	234 - 317
Caps	318 - 329
Business	330 - 371
Summer	372 - 421
Greenline	422 - 439
Travel and Bags	440 - 513
Children	514 - 563
Leisure	564 - 587
Dogs	588 - 593
Tools and Torches	594 - 627
Fitness	628 - 675
Import	676 - 687
Baloons	688
Griffe	689



208



440



148



422



628

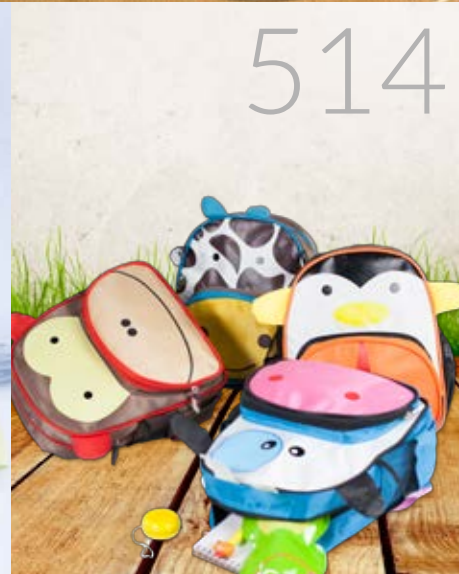

514

READING GUIDE
 ITEM NUMBER..... 48044 *asbest*
 MATERIAL Contapassi | Step counter | Podómetro | Pédomètre
 Plastico | Plastic | Plástico | Plastique
 ITEM SIZE / PRINTING RANGE 3,6 x 5,6 x 2 cm 17 2,5 x 1 cm 100/200
 PRINT SIZE / PACKAGING

Nel catalogo le misure menzionate sono indicative. Ci riserviamo il diritto di effettuare le opportune modifiche dove è necessario. Colori e misure potrebbero cambiare, lasciando inalterata la tipologia del prodotto.
 In this catalogue all the mentioned measures are indicative, we keep the right to make the appropriate changes if necessary. Colours and measures can change, leaving the product typology unchanged.
 En este catálogo todas las medidas de los productos mencionadas son indicativas, nos reservamos el derecho de poner cambios cuando sea necesario. Colores y medidas pueden cambiar sin alterar el tipo de producto.
 Dans le catalogue toutes les mesures des produits mentionnés sont approximatives. Nous nos réservons le droit d'apporter changements utiles si nécessaire. Les couleurs et les mesures pourraient changer laissant la typologie des produits inchangée.

WRITING *your* STORY:

Penne a sfera in plastica, metallo, carta, bamboo, sughero e legno. Penne touchscreen, evidenziatori, set penne in confezione regalo e molto altro...

2-71

scrittura - writing - escritura - écriture



20272 *gimigliano*

Penna a sfera con meccanismo a rotazione | Ball pen with twist mechanism |
Bolígrafo con apertura giratoria | Stylo bille rotatif
Plastica | Plastic | Plástico | Plastique

14 x Ø 1 cm | T1 | UV1 3 x 0,8 cm | 50/1000

20271 *amethyst*

Penna a sfera con meccanismo a rotazione | Ball pen with twist mechanism |
Bolígrafo con apertura giratoria | Stylo bille rotatif
Plastica | Plastic | Plástico | Plastique

14 x Ø 1 cm | T1 | UV1 3 x 0,8 cm | 50/1000





20031 **kuk** *ln*

Penna a sfera | Ballpoint pen | Bolígrafo | Stylo à bille
Plastica | Plastic | Plástico | Plastique

13,8 x Ø 1,25 cm T1 | UV1 4 x 0,7 cm 50/1000

allpoint
Bpen

20239 **beaumont**

Penna a sfera | Ballpoint pen | Bolígrafo | Stylo à bille
Plastica | Plastic | Plástico | Plastique

13,8 x Ø 1,25 cm T1 | UV1 4 x 0,7 cm 100/1000



.17



20791 **kixo** *ln*

Penna a sfera | Ballpoint pen | Bolígrafo | Stylo à bille
Plastica | Plastic | Plástico | Plastique

13,8 x Ø 1,25 cm T1 | UV1 4 x 0,7 cm 100/1000

20035 **petal** *ln*

Penna a sfera con corpo trasparente | Transparent ballpoint pen
| Bolígrafo transparente | Stylo à bille avec corp transparent
Plastica | Plastic | Plástico | Plastique

13,8 x Ø 1,25 cm T1 | UV1 4 x 0,7 cm 50/1000



20147 **emma**

Penna a sfera | Ballpoint pen | Bolígrafo | Stylo à bille
Plastica | Plastic | Plástico | Plastique

13,8 x Ø 1,25 cm T1 | UV1 4 x 0,7 cm 100/1000



20274 *gavello*

Penna a sfera | Ballpoint pen | Bolígrafo | Stylo à bille
Plastica | Plastic | Plástico | Plastique

 13,8 x Ø 1,25 cm  T1 | UV1 4 x 0,7 cm  50/1000



20300 *hemmahos*

Penna a sfera colorata | Coloured ballpen | Bolígrafo de color | Stylo bille coloré
Plastica | Plastic | Plástico | Plastique

 14 x Ø 1,1 cm  5 x 0,6 cm T1  1000





20290 *hemgjord*

Penna a sfera bianca con dettagli colorati | White ballpen with coloured details |
Bolígrafo blanco con detalles de color | Stylo bille coloré avec détails colorés
Plastica | Plastic | Plástico | Plastique

 14 x Ø 1,1 cm  T1  1000

20034 *malia*



Penna a sfera con clip e molla in metallo | Ballpoint pen with silver satin
barrel and chrome fittings | Bolígrafo con clip de metal | Stylo à bille
avec clip, tige en métal
Plastica, metallo | Plastic, Metal | Plástico, Metal | Plastique, Métal

 13 cm  T1 | UV1 3,5 x 0,8 cm  50/1000



20030 *mika*

Penna a sfera con clip e molla in metallo | Ballpoint pen with silver satin
barrel and chrome fittings | Bolígrafo con clip de metal | Stylo à bille
avec clip, tige en métal
Plastica, metallo | Plastic, Metal | Plástico, Metal | Plastique, Métal

 13 cm  T1 | UV1 3,5 x 0,8 cm  50/1000





.07 .08 .05 .04 .32 .01

20141 *ilta*

Penna a sfera refill jumbo | Ballpoint Jumbo refill pen | Bolígrafo carga jumbo | Stylo à bille recharge jumbo
Plastica, metallo | Plastic, Metal | Plástico, Metal | Plastique, Métal

☞ 13,8 cm ☞ T1 | UV1 3,5 x 0,7 cm ☞ 50/500



.08 .07 .04

20018 *mel*

Penna a sfera con impugnatura in gomma | Ballpoint pen with rubber grip | Bolígrafo con agarre de goma | Stylo à bille avec prise en gomme
Plastica | Plastic | Plástico | Plastique

☞ 14,4 cm ☞ T1 | UV1 3,5 x 0,7 cm

☞ 50/1000



.08

20047 *malie*

Penna a sfera | Ballpoint pen | Bolígrafo | Stylo à bille
Plastica | Plastic | Plástico | Plastique

☞ 12,9 cm ☞ T1 3,5 x 0,8 cm

☞ 50/1000



.04

20049 *manu*

Penna a sfera con clip in metallo | Plastic ballpoint pen with metal clip | Bolígrafo de plástico con pulsador | Stylo à bille avec clip en metal
Plastica, metallo | Plastic, Metal | Plástico, Metal | Plastique, Métal

☞ 13,8 x Ø 1,25 cm ☞ T1 | 3 x 0,7 cm ☞ 100/1000



.06 .07 .08 .17 .23 .19 .04 .02

20196 *seaford*

Penna a sfera con impugnatura in gomma | Ballpoint pen with grip | Bolígrafo con antideslizante | Stylo à bille avec poignée en caoutchou
Plastica | Plastic | Plástico | Plastique

☞ 13,8 cm Ø 1 cm ☞ T1 | UV1 3 x 0,6 cm ☞ 50/1400



.02 .01 .32 .05 .08

20074 *gemma*

Penna a sfera | Ballpoint pen | Bolígrafo | Stylo à bille
Plastica | Plastic | Plástico | Plastique

☞ 13,7 x Ø 1,1 cm ☞ T1 3 x 0,7 cm ☞ 50/1000



.06 .19 .07 .08 .23

20126 *raila*

Penna a sfera | Ballpoint pen | Bolígrafo | Stylo à bille
Plastica | Plastic | Plástico | Plastique

☞ 13,7 x Ø 1,3 cm ☞ T1 | UV1 3 x 0,8 cm ☞ 50/600



.07 .01 .32 .05 .17

20199 *modibo*

Penna a sfera | Ballpoint pen | Bolígrafo | Stylo à bille
Alluminio | Aluminium | Aluminium | Aluminium

☞ 13,5 x Ø 0,8 cm ☞ T3 | L1 4 x 0,6 cm ☞ 50/1000



.08 .07

20061 *jal*



Penna a sfera traslucida con clip in metallo | Frosted Ballpoint pen with metal clip | Bolígrafo transparente con clip de metal | Stylo à bille translucide avec clip en métal
Plastica, metallo | Plastic, Metal | Plástico, Metal | Plastique, Métal

☞ 13 cm ☞ T1 | UV1 4 x 0,6 cm ☞ 50/1000



20813 *asha*

Penna a sfera | Ballpoint pen | Bolígrafo | Stylo à bille
 Plastica | Plastic | Plástico | Plastique

 13,8 x Ø 1 cm  T1.5 x 0,7 | UV1.5 x 0,5 cm  50/1000





20999 *assim*

Penna a sfera | Ballpoint pen | Bolígrafo | Stylo à bille
 Plastica | Plastic | Plástico | Plastique

 13,8 x Ø 1 cm  T1 | UV1.5 x 0,7 cm  50/1000

20058 *emmi*

Penna a sfera traslucente | Transparent ballpoint pen with clip | Bolígrafo transparente | Stylo à bille translucide
Plastica | Plastic | Plástico | Plastique

 13 cm  T1 5 x 0,7 cm  50/1000



20116 *kandi*

Penna a sfera | Ballpoint pen | Bolígrafo | Stylo à bille
Plastica | Plastic | Plástico | Plastique

 12,8 cm x Ø 1,23 cm  T1 | UV1 3,5 x 0,7 cm  100/1000



Writing
12

20022 *elsi*

Penna a sfera | Ballpoint pen | Bolígrafo | Stylo à bille
Plastica | Plastic | Plástico | Plastique



 14,4 x Ø 1 cm  T1 | UV1 3 x 0,6 cm  50/1000



Writing
13

20028 *liko*

Penna a sfera | Ballpoint pen | Bolígrafo | Stylo à bille
Plastica | Plastic | Plástico | Plastique

 13,8 cm  T1 5 x 0,7 cm  50/1000



20079 *mak*

Penna a sfera | Ballpoint pen | Bolígrafo | Stylo à bille
Plastica | Plastic | Plástico | Plastique

 14,3 cm  T1 4 x 0,7 cm  50/1000





.07 .08 .18 .19 .01 .05

20155 *juli*

Penna a sfera | Ballpoint pen | Bolígrafo | Stylo à bille
Plastica | Plastic | Plástico | Plastique

13,5 x Ø 1,2 cm T1/UV1 4 x 0,7 cm 50/1400



.05 .01 .07 .04 .08

20138 *albin*

Penna a sfera | Ballpoint pen | Bolígrafo | Stylo à bille
Plastica | Plastic | Plástico | Plastique

14 X Ø 1 cm T1 | UV1 4 x 0,7 cm 50/1000



.07 .08 .18 .05 .04 .02 .32 .01

20260 *calais*

Penna a sfera | Ballpen | Bolígrafo | Stylo à bille
Plastica | Plastic | Plástico | Plastique

14 x 1,1 Ø cm T1 | UV1 4 x 0,7 cm 100/1000



.08 .05 .04 .32 .01

20182 *gunnar*

Penna a sfera | Ballpoint pen | Bolígrafo | Stylo à bille
Plastica, Metallo | Plastic, Metal | Plástico, Metal | Plastique, Métal

13,5 x Ø 1 cm T1 | UV1 3 x 0,7 cm 50/1000



.04

.24

20050 *elan*

Penna a sfera, traslucente | Translucent ballpoint pen | Bolígrafo
transparente | Stylo à bille translucide
Plastica | Plastic | Plástico | Plastique

14 cm T1 4,5 x 0,6 cm 50/1000



.08

.01

20042 *memole*

Penna a sfera, scatto a pulsante con disco colorato | Ballpen, push button
with coloured disc | Bolígrafo con 2 esferas transparentes y pulsador | Stylo
à bille snap-bouton avec disque coloré
Plastica | Plastic | Plástico | Plastique

15 cm T1 | UV1 3 x 0,6 / 4 x 0,7 cm 50 / 1000



.08 .05 .19 .18

20000 *gesico*

Penna a sfera | Ballpoint pen | Bolígrafo | Stylo à bille
Plastica | Plastic | Plástico | Plastique

14 x Ø 1,2 cm T1 3,5 x 0,7 cm 50/1000



gesico



.05 .06 .07 .08 .02

20071 *sihu*

Penna a sfera | Ballpoint pen | Bolígrafo | Stylo à bille
Plastica | Plastic | Plástico | Plastique

13 x Ø 1,5 cm T1 | UV1 2 x 0,7 cm 50/1000



.06 .08 .04 .05

20026 *sari*

Penna a sfera con impugnatura in gomma e clip traslucente | Ballpoint pen
with rubber grip and translucent clip | Bolígrafo con pulsador y antideslizante
| Stylo à bille avec prise en gomme et clip translucide
Plastica | Plastic | Plástico | Plastique

13,2 cm T1 4 x 0,7 cm 50/1000



BALL POINT

pen



20269 *ammolite* *m*

Penna a sfera con meccanismo a rotazione | Ball pen with mechanic rotation | Bolígrafo con apertura por rotación | Stylo bille à mécanisme rotatif

Plastica | Plastic | Plástico | Plastique

14 cm T1 | UV1 4 x 0,6 cm 50/1000



20267 *amman* *m*

Penna a sfera con meccanismo a rotazione | Ball pen with mechanic rotation | Bolígrafo con apertura por rotación | Stylo bille à mécanisme rotatif

Plastica | Plastic | Plástico | Plastique

14 cm T1 | UV1 4 x 0,6 cm 50/1000



.02 .05 .01



.05 .02



.08 .06 .02 .05

20077 *loto*

Penna a sfera realizzata con derivati del mais | Ballpoint pen made of corn derivatives | Bolígrafo ecológico con pulsador | Stylo à bille réalisé avec les dérivés du maïs
Plastica | Plastic | Plástico | Plastique

15 cm T1 UV1 3,5 x 0,8 cm 50/1000

20143 *kono*

Penna a sfera | Ballpoint pen | Bolígrafo | Stylo à bille
Plastica | Plastic | Plástico | Plastique

13,5 cm T1 UV1 4,5 x 0,6 cm 50/1000

20110 *aid*

Penna a sfera | Ballpoint pen | Bolígrafo | Stylo à bille
Plastica | Plastic | Plástico | Plastique

14,7 x Ø 1 cm T1 4 x 0,6 cm 50/1000



.06



.08



.04



20081 *mangal*

Penna a sfera | Ballpoint pen | Bolígrafo | Stylo à bille
Plastica | Plastic | Plástico | Plastique

13,7 x Ø 1,5 cm T1 2,5 x 0,7 cm 50/1000

mangal

.07 .08 .18 .29 .01 .02



.08 .60 .03



.08 .07 .03



.05 .01 .07

20057 *yuma*

Penna a sfera, traslucida con clip in metallo | Frosted ballpoint pen, with metal clip | Bolígrafo transparente con clip de metal | Stylo à bille, translucide avec clip en métal
Plastica, Metallo | Plastic, Metal | Plástico, Metal | Plastique, Métal

13,3 x Ø 1,1 cm T1 4 x 0,7 cm 50/1000

20055 *misu*

Penna a sfera | Ballpoint pen | Bolígrafo | Stylo à bille
Plastica, Metallo | Plastic, Metal | Plástico, Metal | Plastique, Métal

13,5 cm T1 UV1 3,5 x 0,8 cm 50/1000

20142 *megan*

Penna a sfera | Ballpoint pen | Bolígrafo | Stylo à bille
Plastica | Plastic | Plástico | Plastique

14 cm T1 UV1 4 x 0,7 cm 50/1000

20144 *agnes* 

Penna a sfera | Ballpoint pen | Bolígrafo | Stylo à bille
Plastica | Plastic | Plástico | Plastique

13,8 cm  T1 / UV1  50/1000

WR



.32 .07 .08 .18 .19



Writing
20



.02 .06 .07 .17 .01 .04 .08 .05

20205 *ovenia* 

Penna a sfera | Ballpoint pen | Bolígrafo | Stylo à bille
Plastica | Plastic | Plástico | Plastic

14,2 x Ø 1 cm  T1 | UV1  50/1000



MATCHING your style

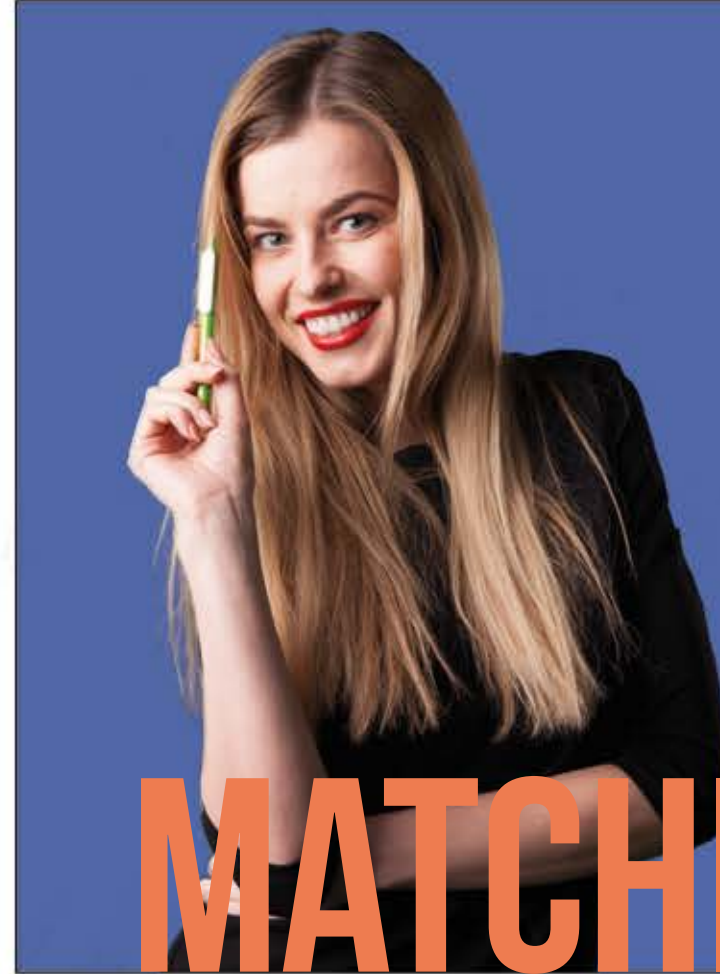

.06 .07 .08 .17 .05 .19 .02

20280 *hektar*

Penna a sfera colorata con clip bianca | Coloured ballpen with white clip |
Bolígrafo de color con clip blanco | Stylo bille coloré avec clip blanc
Plastica | Plastic | Plástico | Plastique

13,70 x Ø 1,1 cm  T1  1000



.01





.06 .05 .18 .04 .02 .01



.06 .02 .01 .05



.08



.08

20133 *katri*

Penna a sfera | Ballpoint pen | Bolígrafo | Stylo à bille
Plastica | Plastic | Plástico | Plastique

14,5 x Ø 0,8 cm T1 5 x 0,5 cm 50/1200

20207 *castore*

Penna a sfera | Ballpoint pen | Bolígrafo | Stylo à bille
Plastica | Plastic | Plástico | Plastique

12,5 x Ø 0,8 cm T1 5 x 0,5 cm 50/2000



.08 .01 .02 .04 .06 .07 .17



.05

22133 *uglich*

Penna a sfera | Ballpen | Bolígrafo | Stylo à bille
Plastica | Plastic | Plástico | Plastique

14,5 x Ø 1 cm T1 | UV1 5 x 0,6 cm 50 / 1000

20211 *asimina*

Penna a sfera | Ballpoint pen | Bolígrafo | Stylo à bille
Plastica | Plastic | Plástico | Plastique

12,5 x Ø 0,8 cm T1 5 x 0,5 cm 50/2000



asimina

.06 .07 .08 .18 .05 .04 .02 .01

TREND PATTERN BODY



20278 *skyn*

Penna con fusto tipo pneumatico | Ballpen with tyre shape | Bolígrafo con agarradera estilo neumático | Stylo avec corps gommé
Plastica | Plastic | Plástico | Plastique

 14 x Ø 1,15 cm  T1 3 x 0,6 cm  50 / 1000



.23 .06 .02

20180 *mahendra*

Penna a sfera 2 in 1 con impugnatura gommata | 2 in 1 ballpoint pen with rubber grip | Bolígrafo 2 en 1 con agarre de goma | Stylo à bille 2 en 1 avec poignée en caoutchouc
Plastica | Plastic | Plástico | Plastique

 14 x Ø 1,3 cm  T1 4 x 0,5 cm  55/1100



.06 .08 .04 .05 .02



.07 .05 .04

20046 *kai*

Penna a sfera con clip, refill: blu, verde, rosso e nero | Ball pen with soft grip and clip, 4 refills: blue, green, black and red | Bolígrafo 4 colores: blu, verde, rojo, negro | Stylo à bille avec clip, 4 couleurs bleu, vert, rouge et noir
Plastica | Plastic | Plástico | Plastique

 14 x Ø 1,2 cm  T1 4 x 0,7 cm  50/1000



.08

20139 *simin*

Penna a sfera mini con anello portachiavi | Mini ballpen with metal ring | Boligrafo mini con llavero | Mini stylo à bille avec anneau porte clés

Plastica, metallo | Plastic, Metal | Plástico, Metal | Plastique, Métal

10 x Ø 0,8 cm T2 UV16 3,5 x 0,5 cm 50/1000



.08

20069 *maye*

Penna a sfera "Rossetto" | Lipstick shaped ballpoint pen | Boligrafo pintalabios | Stylo à bille en forme de rouge à lèvres

Plastica | Plastic | Plástico | Plastique

10 x Ø 1,5 cm T2 UV2 2,5 x 0,8 cm 50/1000



.08

.07

.05

.01

20023 *lila*

Penna a sfera con laccio da collo e chiusura di sicurezza | Ballpoint pen with safety fastening lanyard | Boligrafo con lanyard y cierre seguridad | Stylo à bille avec lacet pour le cou et fermeture de sécurité

Plastica | Plastic | Plástico | Plastique

10,1 cm T2 2 x 0,8 cm 50 /1000



.29

.07

.08

20008 *sanu*

Mini penna a sfera traslucida | Frosted ballpoint pen | Mini boligrafo transparente | Stylo à bille translucide

Plastica | Plastic | Plástico | Plastique

11 cm T2 2,5 x 0,8 cm 50/1000



.08

20264 *leninskiy*

Penna a sfera con luce | Ballpoint pen with light | Boligrafo con linterna | Stylo à bille avec lumière

Plastica | Plastic | Plástico | Plastique

13 x Ø 2,1 cm T23 2 x 0,8 cm 50/500



.05

.06

.04



.05

.17

.07

.06

.04

.08

.01

.02

20215 *bouse*

Mini penna | Mini ballpoint pen | boligrafo mini | Mini stylo

Plastica | Plastic | Plástico | Plastique

9,6 x Ø 1 cm T1 UV1 3 x 0,7 cm 100/2000



.01

.08

.02



.05

40145 *mask*

Stilofo | Desk ball pen | Boligrafo de escritorio | Stylo à bille de comptoir

Plastica | Plastic | Plástico | Plastique

5,6 x 17 x 5,6 cm T7 UV3 4 x 4 cm 1/100



.32





.18

.08

23012 *waterbury*

Penna calibro | Gauge pen | Bolígrafo | Stylo pied à coulisse
Plastica | Plastic | Plástico | Plastique

15 cm  T2 4 x 0,7 cm  50/1000

20037 *dibe*



Penna a sfera Siringa con liquido colorato | Syringe ballpen with coloured liquid | Bolígrafo en forma de jeringuilla | Stylo à bille en forme de seringue
Plastica | Plastic | Plástico | Plastique

12,7 cm  T2 4 x 0,7 cm  50/1000



22029 *sike*

Penna a sfera 2 in 1 | Ball pen 2 in 1 | Bolígrafo 2 en 1 | Stylo à bille 2 in 1
Plastica | Plastic | Plástico | Plastique

14 cm x Ø 1 cm  T1 | UV1 5 x 0,7 cm  50/1000



.08

20212 *planet*

Penna a sfera con pallina "mondo" | Ball Pen with ball "world" | Bolígrafo con bola "mundo" | Stylo avec balle "monde"
Plastica | Plastic | Plástico | Plastique

16,2 x Ø 1,2 cm  T2 4 x 0,7 cm  50/1000

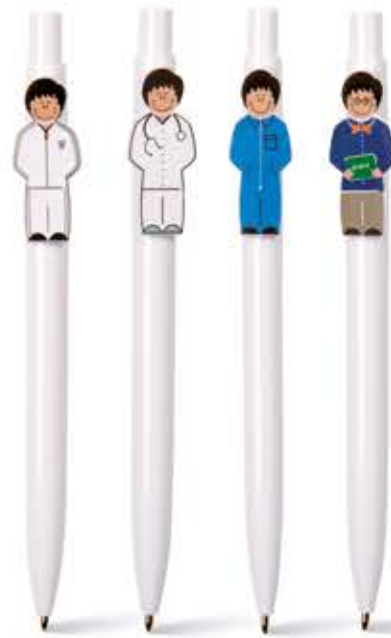

.01

.02

.18

.05

20240 *berkeley*

Penna a sfera con clips professioni | Ballpen with professions dolls | Bolígrafo con figuras profesiones | Stylo à bille avec clips professions
Plastica | Plastic | Plástico | Plastique

13,5 cm  T2 4 x 0,6 cm  50/1000



.21

20085 *taima*

Stiloforo satinato con 3 penne a sfera, inchiostro rosso-nero-blu | Frosted pen holder with 3 pens, blue black and red ink | 3 Bolígrafos en soporte. Escritura azul, negra y roja | Set 3 stylos à bille. Encre noir, bleu et rouge
Plastica | Plastic | Plástico | Plastique

12 x 10,5 x 11,5 cm  T7 5 x 1,5 cm  1/200



.02

.01

.23

.04

.08

20814 *fixa*

Penna a sfera con dettagli cromati | Ballpen with chrome plated details | Bolígrafo con detalles cromados | Stylo avec détails chromés
ABS | ABS | ABS | ABS

13,5 x Ø 1,2 cm  T2 3 x 0,7 cm  50/500

BALL POINT light

20036 *tilda* 

Penna a sfera con lampeggiante | Ballpoint pen with a flashing light on the top | Bolígrafo con luz intermitente en el extremo superior | Stylo à bille avec lampe
Plastica | Plastic | Plástico | Plastique

 18,5 x Ø 2,8 cm  T2 4 x 0,4 cm  25/200



.06

.07

.08

.17

.23

.04

.18



.04

.17

.08

21030 *elabuga* 

Penna a 2 colori con luce | 2 colors pen with light | Bolígrafo con 2 tintas y luz | Stylo 2 couleurs
Plastica | Plastic | Plástico | Plastique

 19 cm  T2 4 x 0,6 cm  25/500



29001 *lise* 

Set 2 penne a sfera con memo | Ballpoint pens in plastic case with memo stickers and clip.(2 pens) | Estuche con bloc de notas y 2 bolígrafos | Collection 2 stylo à bille avec memo
Plastica | Plastic | Plástico | Plastique

 15 x 2 x 1,8 cm  T7 4 x 1 cm  50/500



.08

BALL POINT with memo

29030 *meda* 

Penna a sfera con impugnatura in gomma dotata di porta foglietti memo | Ballpoint pen with sticky notes and rubber grip | Bolígrafo transparente con antideslizante y pulsador | Stylo à bille doté d'un porte feuilles memo
Plastica | Plastic | Plástico | Plastique

 14,5 cm  T2 | UV16 4 x 0,6  50/500



.05

.08

.01



PROPELLING *pencil*

20033 *moki*

Matita con mina e gomma | Propelling pencil with erase |
Portaminas con goma | Crayon avec mine et gomme
Plastica | Plastic | Plástico | Plastique

13 x 0,8 cm T1 | UV1 5 x 0,5 cm 100/2000

.06 .08 .05 .01 .02 .04

TOUCHSCREEN *pencil*



96898 *fjällbo*

Matita touchscreen | Touchscreen pencil |
Lápiz con puntero táctil | Stylo stylet
Legno | Wood | Madera | Bois

19 x Ø 0,7 cm T27 6 x 0,5 cm



.02 .00 .01

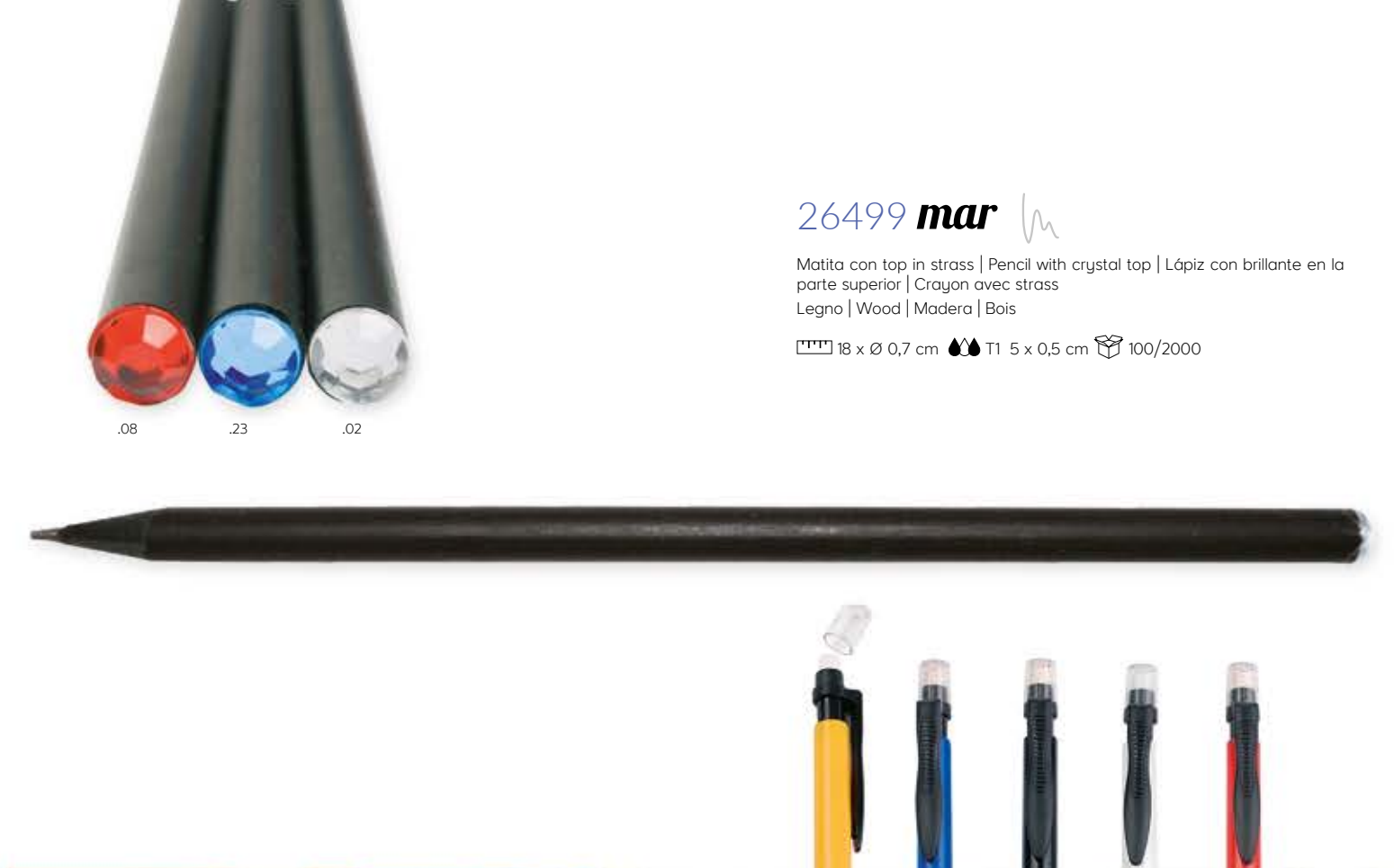

26499 *mar*

Matita con top in strass | Pencil with crystal top | Lápiz con brillante en la
parte superior | Crayon avec strass
Legno | Wood | Madera | Bois

18 x Ø 0,7 cm T1 5 x 0,5 cm 100/2000

.08 .23 .02



20183 *gunvald*

Matita portamine 0,5 mm | Propelling pencil 0,5 mm | Portaminas 0,5
mm | Crayon porte-mines 0,5 mm
Plastica | Plastic | Plástico | Plastique

15,1 x Ø 0,7 cm T2 | UV16 4 x 0,6 cm 50/1000

.06 .05 .01 .02 .08



29007 *noor*

Evidenziatore 5 colori | Text marker, (five colours) | Marcador con 5 colores en forma de flor | Marqueur à 5 couleurs
Plastica | Plastic | Plástico | Plastique

10 x 2 cm S2 | UV2 Ø 4 cm 50/250



29142 *olga*

Evidenziatore 'Mano' 5 colori | Text marker, (5 colours) | Marcador con 5 colores | Marqueur "main" (en forme de main) 5 couleurs
Plastica | Plastic | Plástico | Plastique

9,4 x 7,4 cm S2 | UV2 3 x 2 cm 50/250



29580 *släkting*

Evidenziatore | Highlighter | Subrayador fluorescente | Surligneur
Plastica | Plastic | Plástico | Plastique

SP3 3 x 1 cm 50 / 1000

HIGHLIGHTING your world



29005 *katri*

Evidenziatore 3 colori | Text marker (3 colours) | Marcador con 3 colores | Marqueur à 3 couleurs
Plastica | Plastic | Plástico | Plastique

9 x 9 x 1,5 cm S2 | UV2 3 x 2 cm 50/250



29171 *monstera*

Evidenziatore lampadina | Highlighter | Marcador amarillo | Surligneur ampoule
Plastica | Plastic | Plastica | Plastic

4,4 x 7,5 x 1,6 cm T6 | UV2 3 x 2 cm 50/500



.06



.06



.18



.17 .07 .04 .06

29245 *grandate*

Penna a sfera con evidenziatore e touchscreen | Ball pen with touchscreen and highlighter | Bolígrafo con puntero táctil y marcador | Stylo bille avec stylet et surligneur
Plastica | Plastic | Plástico | Plastique

14,3 x ø 1,3 cm T2 | UV16 3 x 0,7 cm

50/500

29248 *grezzana*

Evidenziatore a scatto. | Highlighter | Marcador | Surligneur.
Plastica | Plastic | Plástico | Plastique

15 x ø 1,3 cm T6 3 x 1 cm 50/500

29570 *slående*

Evidenziatore con clip | Highlighter with clip | Subrayador fluorescente con clip | Surligneur
Plastica | Plastic | Plástico | Plastique

T20 3 x 0,7 cm 50 / 1000

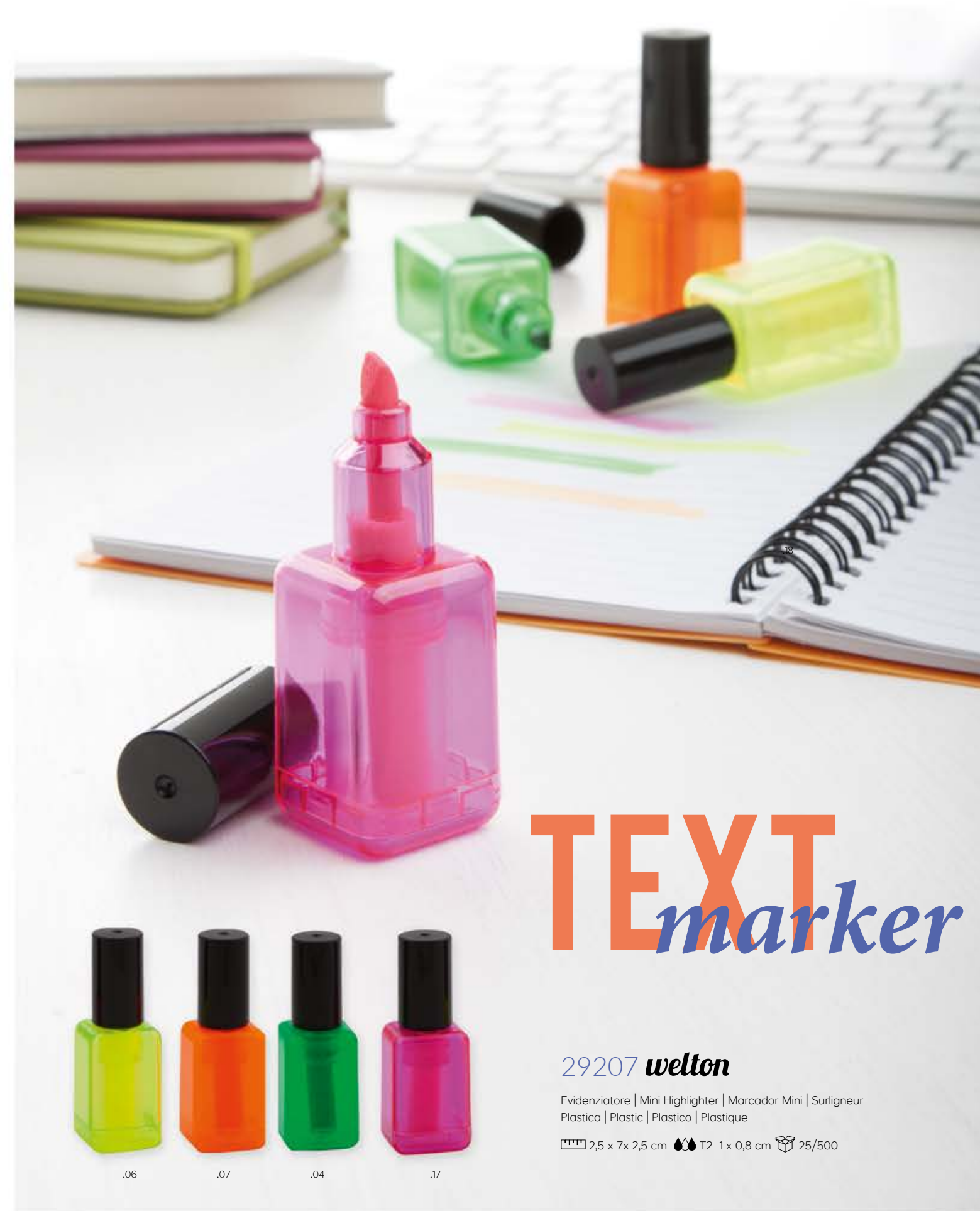

TEXT marker



.06 .07 .04 .17

29207 *welton*

Evidenziatore | Mini Highlighter | Marcador Mini | Surligneur
Plastica | Plastic | Plástico | Plastique

2,5 x 7 x 2,5 cm T2 1 x 0,8 cm 25/500

29111 baku

Set evidenziatori. | Highlighter set | Set de marcadores | Set surligneurs
Plastica | Plastic | Plástico | Plastique

10,5 x 5,5 x 1,5 cm S3 | UV9 2 x 1 cm 50/200



.02



.09

29006 lilla

Penna a sfera tre colori (rosso, blue, nero) con sei evidenziatori intercambiabili |
Three colour ballpoint pen, (red, black, blue) with six replaceable text markers and
rubber grip | Bolígrafo 3 colores (rojo, azul, negro) con 6 marcadores fluorescentes
| Stylo à bille 3 couleurs (rouge, bleu, noir) avec 6 marqueurs interchangeable
Plastica | Plastic | Plástico | Plastique

18 x 6,3 x 2,8 cm S3 | UV9 6 x 4 cm 12/144



.06

.07

.17

.04

.18

29251 galliate

Evidenziatore. | Highlighter | Marcador | Surligneur.
Plastica | Plastic | Plástico | Plastique

2,3 x 6 x 1,4 cm T2 1 x 1 cm 100/1000

TEXT MARKER

pencil

.04



.17



.07

.06



26500 maflu

Matita rotonda temperata | Sharpened Pencil | Lápiz de madera
templada | Crayon rond taillé
Legno | Wood | Madera | Bois

17,5 Ø 0,7 cm T1 8 x 0,5 cm 50/2000

29249 gassino

Set con clips e adesivi colorati | Sticky notes set | Set de notas
adhesivas y clips | Set avec adhésifs multicolores
Plastica, carta | Plastic, paper | Plástico, papel | Plastique, papier

2 x 1 cm 50/200



.02

LIGHTUP YOUR logo!

“
Luce led interna
che illumina
il tuo logo
...
Impugnatura in gomma soft touch
Gommino touch screen che fa da
bottone on/off
Puntale in metallo
Elegante rifinitura satinata
Disponibile in tante varianti colore
”

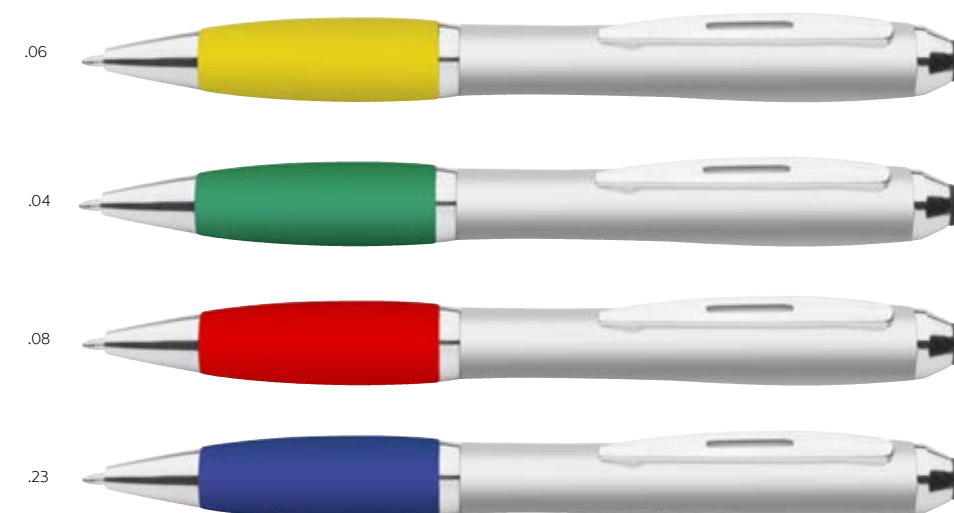
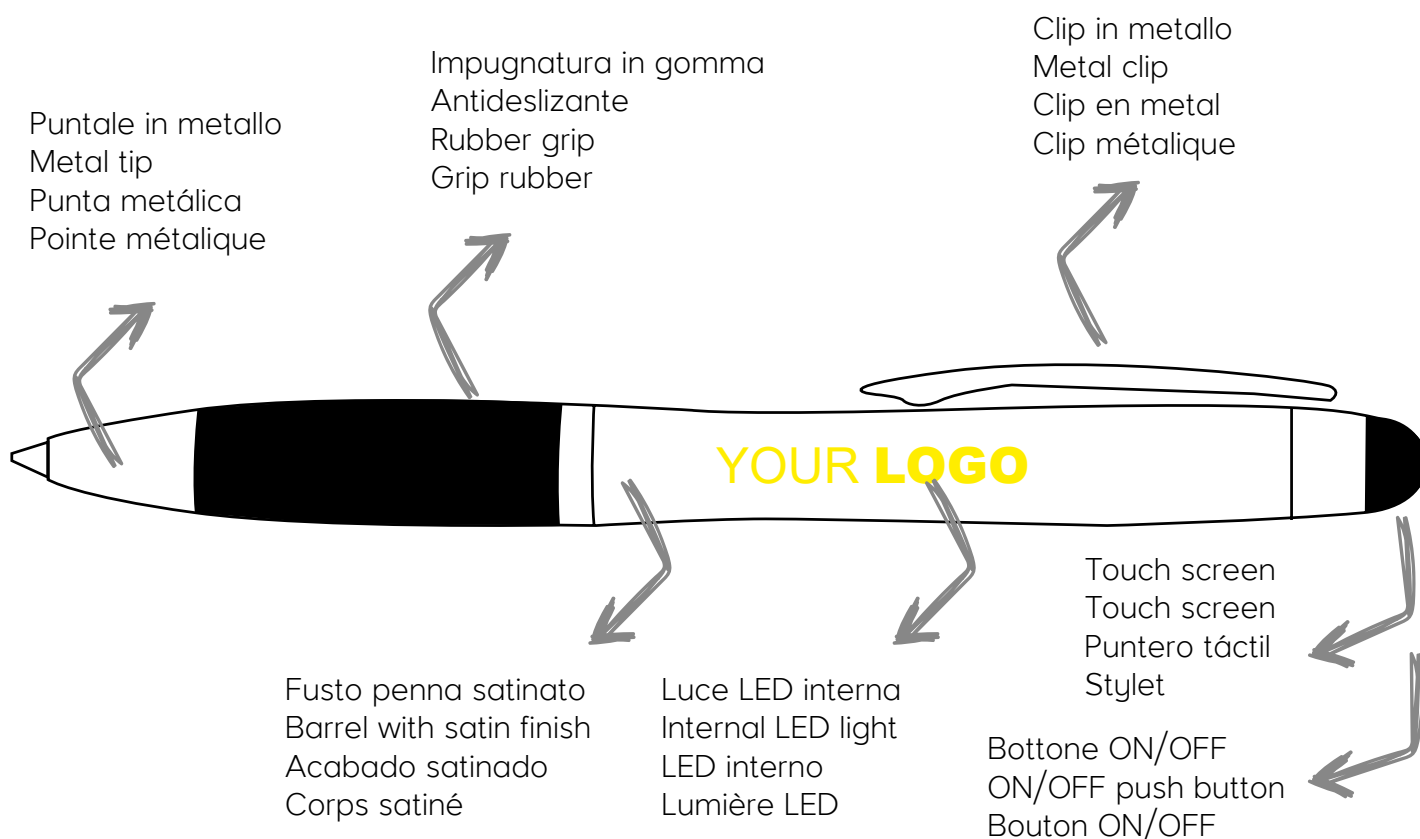

20998 coccolus

Penna touchscreen con logo luminoso. Batterie incluse | Touchscreen ballpen with luminous logo. Batteries included | Bolígrafo con puntero táctil y logo luminoso. Pilas incluidas | Stylo stylet avec logo lumineux. Batterie incluse

Plastica | Plastic | Plastique | Plástico

13,5 x Ø 1,4 cm | L1 | T1 3 x 0,6 cm | 50/1000



22915 fintorp

Penna touchscreen con logo luminoso. Batterie incluse | Touchscreen ballpen with luminous logo. Batteries included | Bolígrafo con puntero táctil y logo luminoso. Pilas incluidas | Stylo stylet avec logo lumineux. Batterie incluse

Plastica | Plastic | Plastique | Plástico

13,8 x Ø 1,3 cm | L1 | T1 3 x 0,6 cm | 50/1000





.08 .23 .32 .04

20273 *grosio*

Penna con puntatore touch | Touchscreen ballpen | Bolígrafo con puntero táctil | Stylo à bille avec pointeur tactile
Plastica | Plastic | Plástico | Plastique

13,4 x Ø 1,4 cm T1 | UV1 4 x 0,7 cm 1000



.01



.07 .08 .05 .04 .01

20181 *gandalf*

Puntatore touchscreen con penna sfera | Touchscreen pointer with ballpoint pen | Puntero táctil con bolígrafo | Pointeur tactile avec stylo à bille
Plastica | Plastic | Plástico | Plastique

13,7 x Ø 1,3 cm T1 | UV1 4 x 0,7 cm 50/1000

.02



20170 *alfhild*

Penna a sfera con puntatore touchscreen | Ballpoint pen with touchscreen pointer | Bolígrafo con puntero táctil | Stylo à bille avec pointeur tactile
Plastica | Plastic | Plástico | Plastique

13,5 x Ø 1,3 cm T1 | UV1 4 x 0,7 cm 50/1000



.01 .05 .04 .08 .07 .06

22055 *pitanga*

Penna con puntatore touch | Touchscreen ballpen | Bolígrafo con puntero táctil | Stylo à bille avec pointeur tactile
Plastica | Plastic | Plástico | Plastic

11,5 x Ø 0,9 cm T2 | UV1 3,5 x 0,6 cm 50 / 1000



.05 .08 .04 .32

.01



TOUCHSCREEN



.06 .07 .08 .17 .24 .18 .19 .02 .01

22000 *centennial*

Penna con puntatore touch | Touchscreen ballpen | Bolígrafo con puntero táctil | Stylo à bille avec pointeur tactile
Plastica | Plastic | Plástico | Plastique

13,4 x Ø 1,4 cm T1 | UV1 4 x 0,7 cm 1000





20270 *tatone* 

Penna a sfera touch screen con supporto per cellulare | Touch screen ball pen with mobile phone support | Bolígrafo touch-screen con soporte por móvil | Stylo bille avec stylet et support pour portable
Plastica | Plastic | Plástico | Plastique

 14,7 cm  T1 | UV1 3 x 0,7 cm  50/1000

.07 .08 .23 .18 .04 .01



TOUCHSCREEN



SCREWDRIVER





MOBILE PHONE support



.23

22914 *finstilt* 

Penna con 7 accessori. Compreso pulisci schermo | Ball pen with 7 accessories. Screen cleaner included | Bolígrafo con 7 accesorios. Incluye limpia pantallas | Stylo avec 7 accessoires (nettoyeur d'écran inclus)
ABS | ABS | ABS | ABS

 1,6 X 15,5 X 1,2 cm  L1

TOUCH
SCREEN



.24



.05 .06 .04 .08 .02 .01



.08 .23 .04 .01 .32

20816 *falkner*

Penna a sfera con supporto per cellulare | Ball pen with mobile phone support | Bolígrafo con soporte por móvil | Stylo bille avec support pour portable
Plastica | Plastic | Plástico | Plastique

 14,7 cm  T1 | UV1 3 x 0,7 cm  50 / 1000

20815 *fiskbo*

Penna con pulisci schermo | Ballpen with screen cleaner included | Bolígrafo con limpia pantallas | Stylo avec nettoyeur d'écran
Alluminio | Aluminium | Aluminio | Alluminium

 14 x Ø 1 cm  L1 3 x 0,7 cm



.32

.01

.04

.23

.08



20172 *alice*

Penna a sfera con puntatore touchscreen | Ballpoint pen with touchscreen pointer | Bolígrafo con puntero táctil | Stylo à bille avec pointeur tactile
Plastica | Plastic | Plástico | Plastique

14,5 x Ø 1 cm T1 | UV1 3,5 x 0,6 cm 50/1200



22126 *clearwater*

Penna con puntatore touch, inchiostro 3 colori | Touch ballpen with 3 colors ink | Bolígrafo con puntero táctil, 3 colores | Stylo à bille avec pointeur tactile, encre 3 couleurs
Plastica | Plastic | Plástico | Plastique

14,8 x 1,3 cm T1 | 4 x 0,5 cm 1000



20228 *berlin*

Penna a sfera con touch-screen e strass | Ball pen with touch screen with strass | Bolígrafo con puntero táctil con strass | Stylo à bille avec pointer tactile avec strass
Alluminio | Aluminium | Aluminio | Alluminium

12,8 x Ø 1 cm T3 | L1 3,5 x 0,6 cm



22058 *grumichama*



Penna a sfera con touch-screen | Ball pen with touch screen | Bolígrafo con puntero táctil | Stylo à bille avec pointer tactile
Alluminio | Aluminium | Aluminio | Aluminium

14 x 1 cm L1 3 x 0,5 cm 500

TOUCHSCREEN pen



.06 .07 .08 .05 .01 .19 .02

22153 *garlenda*





Penna a sfera con touchscreen | Touchscreen pen | Bolígrafo con táctil | Stylo à bille avec touch screen
Alluminio | Aluminium | Aluminio | Aluminium

14 x Ø 1 cm T3 | L1 4 x 0,7 cm 50/1000

20192 **sumter** 

Penna a sfera con touchscreen | Touchscreen ballpen | Bolígrafo con puntero táctil | Stylo à bille avec pointeur tactile
Plastica | Plastic | Plastico | Plastique

 13,5 cm  T1 | UV1 3,5 x 0,5 cm  50/1000





.17



20233 **roa** 

Penna a sfera con touch-screen | Ball pen with touch screen | Bolígrafo con puntero táctil | Stylo à bille avec pointeur tactile
Alluminio | Aluminium | Aluminio | Aluminium

 14 x Ø 0,9 cm  T3 | L1 3 x 0,5 cm  50/1000



.02

.01

smart and practical

22911 **lilibit**

Penna touch- screen | Touch screen pen | Bolígrafo táctil | Stylo touch screen
Alluminio | Aluminium | Aluminio | Aluminium

 14 cm  3 | L1 4 x 0,5 cm  50 / 1000

.17

.08

.07

.04

.32

.01

.02

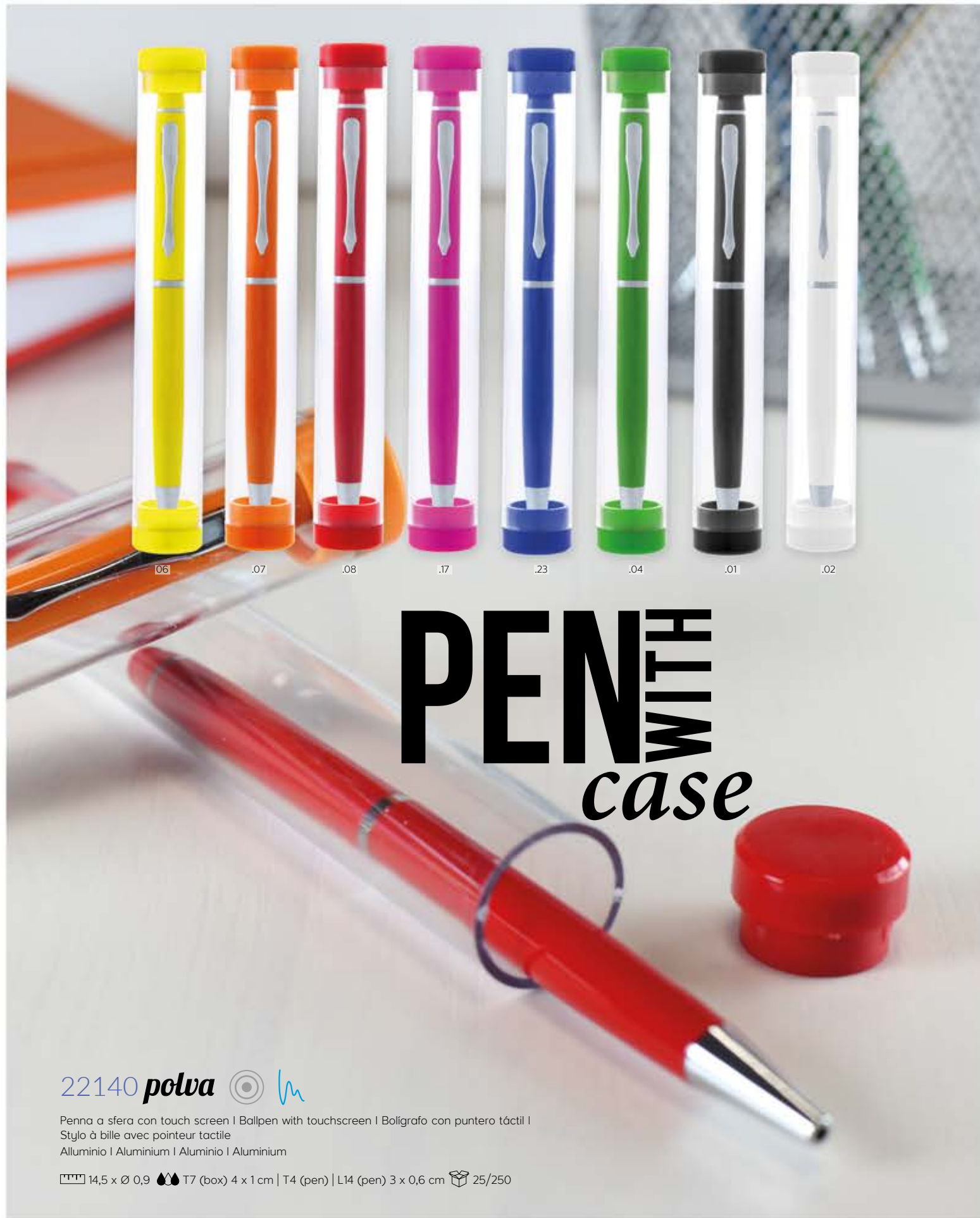

PEN WITH case

22140 *polva*

Penna a sfera con touch screen | Ballpen with touchscreen | Bolígrafo con puntero táctil | Stylo à bille avec pointeur tactile
Alluminio | Aluminium | Aluminio | Aluminium

14,5 x Ø 0,9 T7 (box) 4 x 1 cm | T4 (pen) | L14 (pen) 3 x 0,6 cm 25/250

22141 *kokhuma*

Penna a sfera con touch screen | Ballpen with touchscreen | Bolígrafo con puntero táctil | Stylo à bille avec pointeur tactile
Metallo | Metal | Metal | Métal

15,6 x Ø 2,4 cm T7 (box) 4 x 1 cm | T4 (pen) | L14 (pen) 3 x 0,6 cm 250



22159 *soloniki*

Penna con puntatore touch | Ballpen with touch screen | Bolígrafo con puntero táctil | Stylo à bille avec pointeur tactile
Alluminio | Aluminium | Aluminio | Aluminium

13,5 cm / Ø 2,2 x 15 cm T4 (pen) 4 x 0,6 cm |

T7 (box) 5,5 x 1,2 cm 200

22144 *michel*

Penna a sfera con puntatore touch e led | Touch screen ball pen with Led | Bolígrafo con puntero táctil y led | Stylo bille avec pointeur tactile et led
Alluminio | Aluminium | Aluminio | Aluminium

13 cm T3 | L1 4 x 0,7 cm 50/500



.01 .02 .08 .05

20203 *cocos*

Penna con puntatore touch | Touch Ball Pen | Boligrafo con puntero tactil | Stylo Stylet
Plastica | Plastic | Plástico | Plastic

 15,3 x Ø 1,3 cm  T1 | UV1 3,5 x 0,5 cm  50/1000



.08 .05 .32 .04 .01

22056 *canopo*

Penna con puntatore touch | Touch Ball Pen | Boligrafo con puntero tactil | Stylo à bille avec pointeur tactile
Plastica | Plastic | Plástico | Plastic

 14,5 x Ø 1 cm  T1 | UV1 3 x 0,5 cm  1000



.06

22137 *preston*

Penna a sfera con touch screen | Ballpen with touchscreen | Boligrafo con puntero táctil | Stylo à bille avec pointeur tactile
Plastica | Plastic | Plástico | Plastique

 12,5 x Ø 0,9 cm  T1 | UV1 3,5 x 0,5 cm  50/1000



.07
.08
.23
.04
.01
.02



.07

22005 *aponi*

Penna a sfera con puntatore touchscreen | Ballpoint pen with touchscreen pointer | Boligrafo con puntero táctil | Stylo à bille avec pointeur tactile
Alluminio | Aluminium | Aluminio | Aluminium

 12 x Ø 0,9 cm  T3 | L1 3,5 x 0,5 cm  50/1000



.06
.08
.05
.04
.01
.02



.17

20184 *fofo*

Puntatore touchscreen con penna sfera | Touchscreen pointer with ballpoint pen | Puntero táctil con boligrafo | Pointeur tactile avec stylo à bille
Metallo | Metal | Metal | Métal

 12,5 x Ø 0,9 cm  T3 | L1 | UV1 3,5 x 0,5 cm  50/1000



.06
.08
.05
.04
.01
.02



.23

22135 *pomona*

Penna a sfera e touchscreen con impugnatura in gomma | Ballpen and touchscreen with rubber grip | Boligrafo y puntero con antideslizante | Stylo à bille avec pointeur tactile avec empoignure en caoutchouc
Plastica, Metallo | Plastic, Metal | Plástico, Metal | Plastique, Métal

 13,5 x Ø 1 cm  T1 | UV1 3 x 0,6 cm  50/1000



.06
.07
.08
.17
.04
.01
.02



.32

22041 *evy*

Puntatore touchscreen con penna a sfera | Touchscreen pointer with ballpoint pen | Puntero táctil y boligrafo | Pointeur tactile avec stylo à bille
Plastica, Metallo | Plastic, Metal | Plástico, Metal | Plastique, Métal

 13,5 x Ø 1 cm  T1 | UV1 3,5 x 0,6 cm  50/500



.01
.08
.04
.05

touch

47111 *deneb*

Penna con puntatore touch | Touch Screen Pen | Boligrafo con puntero | Stylo à bille avec pointeur tactile
Plastica | Plastic | Plástico | Plastic

 8,6 x Ø 1 cm  T2 | UV1 3 x 0,7 cm  1000



.05 .04 .08 .01



.01

22154 *tidvatten*

Set penna a sfera e penna roller inchiostro gel | Ballpen and roller ballpen set | Set de bolígrafo y roller | Set stylo à bille et stylo roller gel
Metallo, PU | Metal, PU | Metal, PU | Métal, PU

19 x 9 x 4 cm S86 | L3 14 x 6 cm 50



.01

*Rubber finishing
with chrome background
for shiny engraving*



.01

22152 *gattico*

Penna a sfera. Finitura gommata con fondo cromato per incisione lucida. | Ball Pen, rubber finishing with chrome background for engraving. | Bolígrafo | Stylo bille. Finitions gommées avec fond chromé pour gravure lucide
Metallo | Metal | Metal | Métal

13,5 cm L1 4 x 0,7 cm 50/500

22012 *koa*

Penna a sfera con anello colorato | Stainless steel ballpoint pen | Bolígrafo con clip de metal | Stylo à bille avec anneau coloré
Acciaio | Steel | Acero | Acier

14,3 cm L1 4 x 0,7 cm 50/500



.01

22095 *harrington*

Penna sfera con touchscreen e scatola regalo | Touchscreen ballpen with gift box | Bolígrafo con puntero táctil en caja de regalo | Stylo à bille avec pointeur tactile et boîte cadeau
Metallo | Metal | Metal | Métal

14,5 cm L14 | S86 2,8 x 0,4 cm 50/500



.01



.01



.01

22097 *lewes*

Penna sfera con touchscreen e scatola regalo | Touchscreen ballpen with gift box | Bolígrafo con puntero táctil en caja de regalo | Stylo à bille avec pointeur tactile et boîte cadeau
Metallo | Metal | Metal | Métal

14,5 cm L14 | S86 2,8 x 0,4 cm 50/500

22098 *newark*

Set touch penna a sfera e roller, in scatola regalo imbottita | Roller pen and ball pen set. With touch tip. In padded gift case | Set roller y bolígrafo. Con puntero táctil. En estuche de presentación acolchado | Set roller et stylo à bille avec pointeur tactile dans coffret cadeau
Plastica | Plastic | Plastico | Plastique

5 x 2,5 x 16 cm L3 | S3 3,5 x 1,5 cm 50/100



.02



.01



.03



.03

.32

22151 *berlino*

Penna a sfera | Ball pen | Bolígrafo | Stylo bille
Alluminio | Aluminium | Aluminio | Aluminium

14,1 ø 1 cm 4 x 0,5 cm 50/500

22885 *hind*

Set con penna roller e penna a sfera in astuccio | Roller pen and ball pen set with gift box | Juego de bolígrafo y roller en caja de regalo | Set de stylo à bille et roller en boîte cadeau.

Metallo | Metal | Metal | Métal

17,5 x 5,5 x 2,5 cm S86 | L3 4 x 2 cm / 3,5 x 0,6 cm 10 /100



.01

.02



22094 *mango*

Set penna a sfera e roller. Refill Jumbo | Set with Ball and Roller Pen. Jumbo Refill | Set de bolígrafo y roller.Refil Jumbo | Set de Stylo à bille et Roller. Recharge Jumbo

Alluminio | Aluminium | Aluminio | Aluminium

14 x ø 1,1 cm L3 | S86 3 x 0,6 cm | S2 5 x 2 cm 25/100

22117 *charleston*

Set penna a sfera e roller in scatola regalo | Set of ball pen and roller pen in gift box | Juego de bolígrafos en caja de regalo | Set stylo bille et roller en boîte cadeau

Metallo | Metal | Metal | Métal

18,5 x 7,5 x 3,1 cm S86 | L3 4 x 2 cm / 2,5 x 0,6 cm 15/60



.03



22912 *fjälla*

Penna metallizzata | Shiny metal ballpen | Bolígrafo metalizado | Stylo métallisé
Alluminio | Aluminium | Aluminio | Aluminium

114,2 x Ø 1 cm | L1 3 x 0,6 cm | 50/500

22032 *mia*

Penna a sfera con impugnatura in gomma | Ballpoint pen with rubber grip | Bolígrafo con pulsador y antidesliz. | Stylo à bille avec empoignure en caoutchouc
Plastica | Plastic | Plástico | Plastique

14,1 x Ø 1,4 cm | T1 3 x 0,5 cm | 50 /1000

22014 *muna*

Penna a sfera con impugnatura in gomma | Metal ballpoint pen with rubber grip | Bolígrafo con pulsador y antideslizante | Stylo à bille avec prise en gomme
Alluminio | Aluminium | Aluminio | Aluminium

13,8 x Ø 1 cm | T3 | L1 5 x 0,5 cm | 50/1000

22049 *guus*

Penna a sfera | Ballpoint pen | Bolígrafo | Stylo à bille
Alluminio | Aluminium | Aluminio | Aluminium

13,5 x Ø 1,1 cm | L1 4 x 0,5 cm | 50/500

guus

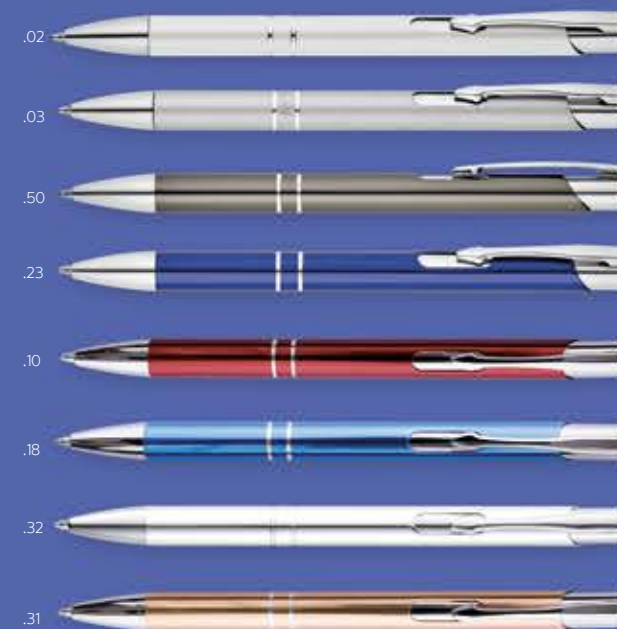



20011 *etu*

Penna con astuccio | Pen with pouch | Bolígrafo con estuche | Stylo à bille avec étui
Metallo | Metal | Metal | Métal

13,5 x Ø 1,1 cm T4/L2 4 x 0,7 cm 50/500



22801 *bená*

Paroure portamina e penna a sfera | Ballpoint pen and propelling pencil | Set de escritura con bolígrafo y portaminas | Collection porte-mine et stylo à bille
Metallo | Metal | Metal | Métal

4,9 x 2,6 x 16 cm T5 | L3 4 x 2 cm 50/100



20097 *nuna*

Set penna a sfera e matita 0,7 mm astucciata | Set with ballpoint pen and 0,7 mm propelling pencil in case | Set bolígrafo y portaminas 0,7 mm con estuche | Collection stylo à bille et crayon 0,7 mm avec étui
Metallo | Metal | Metal | Métal

16 x 5,5 x 2 cm T5 | S3 | L3 4 x 0,6 cm / 4 x 2 cm 50/100



22077 *jambolan*

Set Penna a sfera con refill Jumbo e matita meccanica include mine 0,7 mm | Set with Jumbo Refill Pen and Mechanical Pencil: 0,7 mm Leads Included | Set bolígrafo refill Jumbo y portaminas 0,7 mm | Stylo à bille recharge Jumbo + criterium mines 0,7 mm Includes
Alluminio/Plastica / Aluminium/Plastic / Alluminio/Plastico / Alluminium/plastic

16 x 5,5 x 2 cm T5 (2 pens) | S3 (box) | L3 (2 pens) 50/100

ogre



22130 *ogre*

Penna a sfera con astuccio | Ballpoint pen with box | Bolígrafo con estuche | Stylo à bille avec étui
Alluminio | Aluminium | Aluminio | Aluminium

14 x Ø 1,1 cm T7 (box) | T4 (pen) | L14 (pen) 3 x 0,6 cm / 4 x 1 cm 25/250



22833 *taimi*

Set penna a sfera e matita 0,7 mm | Set with ballpoint pen and 0,7mm propelling pencil | Set bolígrafo y portaminas 0,7 mm | Collection stylo à bille et crayon 0,7 mm
Similpelle, metallo | Imitation Leather, metal | Imitación lider, metal | Demi cuir, metal

6,1 x 17 x 2,2 cm S3 | T5 | L3 5 x 2 cm / 3,5 x 0,7 cm 50/100



22067 *lucumo*

Set penna a sfera e micromina. Mine 0,7 mm include | Set with ball pen and Mechanical Pencil: 0,7 mm leads Included | Set de bolígrafo y portaminas de 0,7 mm incluidas | Set Stylo à bille + criterium mines 0,7 mm includes
Plastica, metallo | Plastic, metal | Plastico, metal | Plastic, metal

14,2 x Ø 1,1 cm T7 (box) | T5 (2 pens) | L3 (2 pens) 4 x 1 / 3 x 0,6 cm 50/250



.05 .02 .08 .01

29170 *longan*

Custodia per penna | Pen Pouch. Cardboard | Estuche para bolígrafo | Étui pour stylo
Cartone | Carton | Carton | Carton

13 x 4 x 15,5 cm S1 1,5 x 1,5 cm 4000



.01 .08 .02 .05

29169 *manghetti*

Custodia per penna | Pen Pouch | Estuche para bolígrafo | Étui Stylo
Similpelle | PU | Polipiel | Simili-cuir

2,5 x 15 cm S1 4 x 1 cm 8000



.32

29067 *randy*

Astuccio per una penna | Pen case | Estuche para un bolígrafo | Étui pour un stylo
Metallo | Metal | Metal | Métal

18 x 6 cm S3 L7 4 x 2 cm 1/100

PEN CASE



.01

29167 *said*

Astuccio per una penna | Pen holder | Estuche por un bolígrafo | Étui pour un stylo
Cartone, Vellutino | Carton, Velvet | Carton, terciopelo | Carton, Velours

17,5 x 5,5 x 2,5 cm S27 5 x 2 cm 50/100



.01

29166 *madan*

Astuccio per una penna | Pen holder | Estuche para un bolígrafo | Étui pour un stylo
Cartone | Carton | Carton | Carton

17 x 4 x 2 cm S27 5 x 2 cm 200



kloose

.19

22051 *kloose*

Penna a sfera con astuccio in feltro | Ballpoint pen with felt pouch
| Bolígrafo con funda de fieltro | Stylo à bille avec étui en feutre
Legno | Wood | Madera | Bois

13 cm T4 L2 3 x 0,7 cm / 4 x 2 cm 50/200



.03

.01

29071 *valma*

Astuccio per una penna | Pen holder (1 pen) | Estuche para un bolígrafo | Étui pour un stylo

15,5 x 3 cm S1 4 x 1 cm 500/3000

allpoint pen



23008 *chicago*

Penna a sfera in bamboo | Ball pen bamboo pen | Bolígrafo de bambú | Stylo à bille en bamboo
Bamboo | Bamboo | Bambù | Bamboo

 13,5 x 1 cm  T3 | L1 4 x 0,7 cm  50/1000



.11

Writing
64

22061 *nou*

Penna a sfera | Ballpoint pen with box | Bolígrafo | Stylo à bille
Bambù | Bamboo | Bambù | Bambou

 13,5 x Ø 1 cm  T1 4 x 0,7 cm  50/1000



.13

20191 *roswell*

Penna a sfera touch-screen | Ballpoint pen | Bolígrafo táctil | Stylo à bille avec tactile
Bamboo | Bamboo | Bambù | Bamboo

 13,5 x Ø 1 cm  T3 | L1 4 x 0,7 cm  50/1000



.11





22047 premier

Set penna a sfera e stilografica | Set with Ball Pen and Fountain Pen | Set de bolígrafo y pluma de madera | Set stylo bille et stylo plume
Bamboo | Bamboo | Bambù | Bamboo

17,4 x 5,4 x 2,3 cm T5 | L3 | S3 3,5 x 0,7 cm / 4 x 2 cm 40/80



22048 consotzis

Penna a sfera in astuccio regalo | Ball Pen in gift box | Estuche con bolígrafo de madera | Stylo bille avec boîte cadeau
Bamboo | Bamboo | Bambù | Bamboo

17 x 4 x 2,5 T4 | L14 | S3 3,5 x 0,7 cm / 4 x 2 cm 40/80



23021 gemonio

Penna a sfera con movimento a rotazione | Ball pen with mechanic rotation | Bolígrafo con apertura por rotación | Stylo bille à mécanisme rotatif

Metallo, sughero | Metal, cork | Métal, corcho | Métal, liège

14 cm T4 | L1 2 x 1 cm 50/200



23061 gandosso

Penna a sfera con astuccio | Ballpoint pen with pouch | Bolígrafo con estuche | Stylo à bille avec étui
Sughero | Cork | Corcho | Liège

13,5 cm T4 5 x 0,5 cm 50/200



23001 laila

Penna a sfera a rotazione | Twist action Ballpoint pen | Bolígrafo de giro | Stylo à bille twist

Legno | Wood | Madera | Bois

13 cm T3 | L1 4 x 0,6 cm 50 /500

22071 lurdessy

Penna a sfera | Ball pen | Bolígrafo | Stylo à bille
Bamboo | Bamboo | Bamboo | Bamboo

15,5 x 4 cm (astuccio) T4 | L2 3,5 x 0,7 cm (pen) 50/600



WOOD line

23803 flyttbar

Penna con inchiostro gel | Bamboo jumbo refill ballpen | Bolígrafo de bambú con tinta de gel | Stylo en bambou avec stylo gel

+Bambù | Bamboo | Bambù | Bambou

14 x Ø 1,3 cm T3 | L1 3,5 x 0,7 cm 50/500



22842 elli

Matita 0,5 mm (ricambio 12 mine) | Propelling pencil (12 0,5 mm mines) | Portaminas (0,5 mm recambio 12 minas) | Crayon 0,5 mm (recharge 12 mines)

Cartone riciclato | Recycled paper | Cartón Reciclado | Carton recyclé

15,8 x 4 x 0,3 cm T5 4 x 0,6 cm 50/600



22838 maisa

Set penna a sfera e matita 0,5 mm | Ballpoint pen and 0,5 mm pencil | Set bolígrafo y portaminas 0,5 mm | Confection stylo à bille et crayon 0,5 mm

Cartone riciclato | Recycled paper | Cartón Reciclado | Carton recyclé

15,8 x 3 x 0,3 cm T5 4 x 0,6 cm 50/600





RECYCLED carton



23018 *seattle*



Penna a sfera in carta riciclata | Recycled pen | Bolígrafo | Stylo à bille
Carta | Recycled carton - Plastic | Papel | Papier recyclé

 13,5 x Ø 0,9 cm  T1 | UV1 5 x 0,7 cm  50/1000



23040 *utby*

Penna a sfera ecologica | Eco ballpen | Bolígrafo eco | Stylo à bille écologique
Plastica, cartone | Plastic, cardboard | Plástico, cartón | Plastique, carton

 16,5 cm  T1 5 x 0,6 cm  1000



RECYCLED *pen*

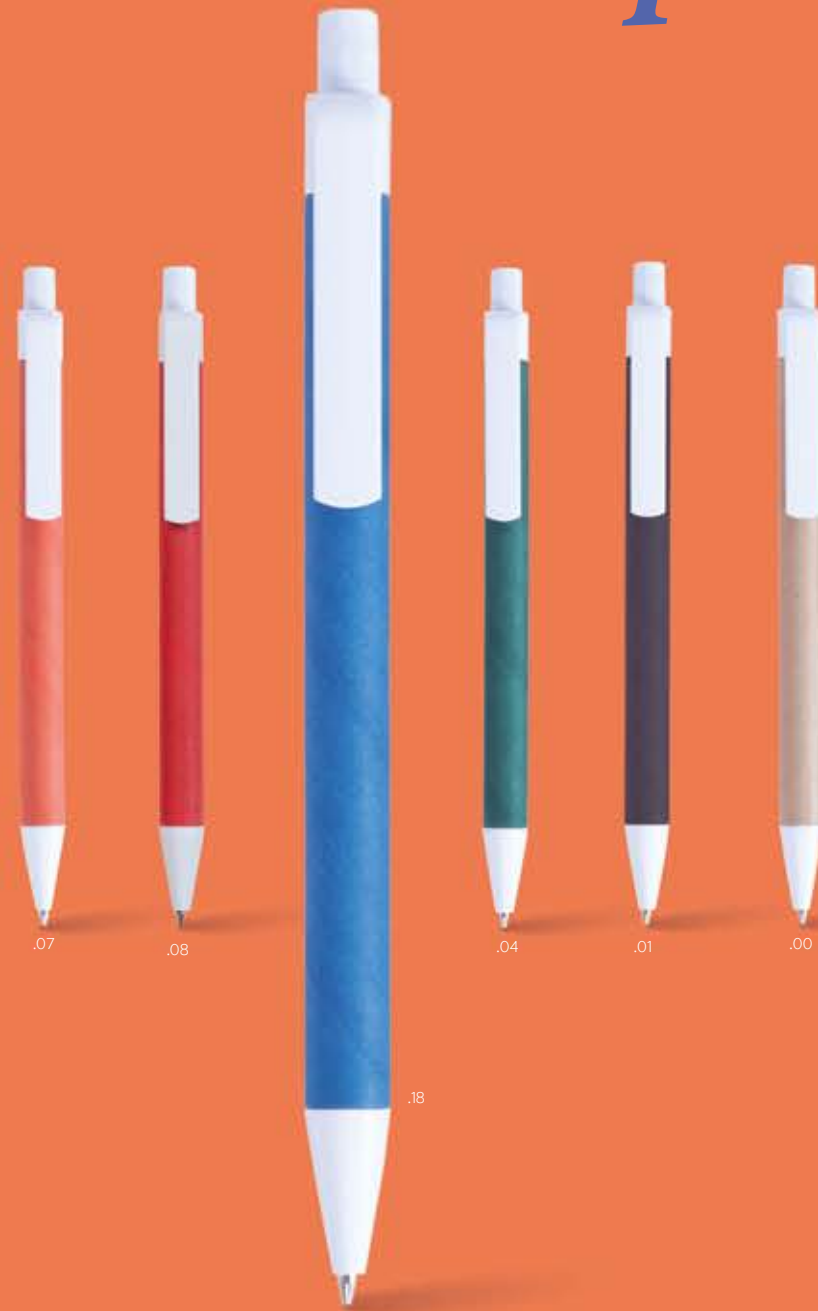

20214 *vegas*

Penna a sfera in carta riciclata | Recycled pen | Bolígrafo | Stylo à bille
Carta | Recycled carton - Plastic | Carton reciclado | Papier recyclé

14 x Ø 0,9 cm T1 | UV1 4 x 0,7 cm 50/1000



23023 *blackstar*

Penna a sfera con puntatore touch | Touch screen ball pen
| Bolígrafo con puntero táctil | Stylo bille avec stylet
Carta, Plastica | Paper, Plastic | Cartón, plástico | Papier,
Plastique

11,5 x Ø 1 cm T2 | UV1 4 x 0,7 cm 50/1000



23002 *manila*

Penna a sfera con fusto in cartone | Ballpoint pen with
cardboard barrel | Bolígrafo de cartón | Stylo à bille avec
tige en carton
Carta riciclabile | Recycled paper | Carton reciclado |
Papier recyclé

14,5 x Ø 0,9 cm T4 5 x 0,5 cm 50/600



23007 *gelsi*

Penna con puntatore touch | Touch Ball Pen |
Bolígrafo con puntero táctil de papel reciclado |
Stylo à bille avec pointeur tactile. Carton Recyclé
Cartone | Carton | Carton | Carton

12,5 x Ø 0,8 cm T1 | UV1 4 x 0,6 cm
1000



TIME & ELECTRONICS

take YOUR:

Orologi da muro digitali e analogici, portapenni da scrivania con orologio incorporato e orologi da polso. Calcolatrici a otto cifre, da tavolo e portatili. Righelli con calcolatrice e walkman radio.

72 - 85

times and electronics



34042 *aoua*

Orologio con stazione meteorologica | Digital clock and weather station | Estacion meteorologica con funcion reloj, alarma etc | Station meteorologique avec fonction montre, alarme etc
Plastica | Plastic | Plástico | Plastique

14 x 8 x 4 cm T8 UV17 5,5 x 2,5 cm 60

aoua

.32



.01

.05

35080 *elena*

Portaoggetti da tavolo con orologio, batterie escluse | Pen holder with clock | Portaobjetos de mesa con reloj. Baterías excluidas | Porte objets de table avec horloge, pile incluse
Plastica | Plastic | Plástico | Plastique

12 x Ø 9cm T8 3 x 1 cm 25/50



.01



.05



.08



.02

36029 *crossandra*

Orologio da parete con movimento al quarzo. Scocca smontabile per una facile personalizzazione interna. | Wall clock. Demontable clock frame for personalisation | Reloj de pared. Cuadrante desmontable con posibilidad de personalización | Horloge murale à quartz. Cadre démontable pour personnalisation cadran
Plastica | Plastic | Plástico | Plastique

📏 Ø 30 cm 💧 T25 (dial) 5 x 4 cm 📦 1/20

CLOCK



36030 *recha*

Orologio da parete, batterie escluse | Wall clock, batteries excl. |
Reloj de pared, baterias excl. | Horloge murale, pile excl.
Plastica, vetro | Plastic, glass | Plástico, vidrio | Plastique, verre

30 x 30 x 5 cm 🔋 T9 4 x 3 cm 📦 1/20



.32

.23

.08



.08



.01

.05

37003 *ambroy*

Orologio da parete, batterie escluse | Wall clock, excl. battery | Reloj de pared sin baterias | Horloge murale, pile excluse
Plastica | Plastic | Plástico | Plastique

2,2 x Ø 32 cm 🔋 S79 (silver part) 5x5 cm 📦 10



.32

36040 *canberra*

Orologio da muro maxi | Maxi wall clock | Maxi reloj | Maxi montre au mure
Plastica | Plastic | Plastica | Plastic

4 x Ø 35 cm 🔋 S79 6x3cm 📦 10



.00

35050 *flori*

Portapenne da scrivania con orologio multifunzione | Desk pen holder and clock with multifunction display | Estuche de lapices por escritorio, multifuncion | Porte-stylos pour bureau avec horloge multifonctions
Plastica | Plastic | Plástico | Plastique

9,8 x 11,7 x 7,5 cm 🔋 T8 | UV18 4 x 2 cm 📦 40/80



.00

35010 *egge*

Portapenne da tavolo con orologio sveglia multifunzioni, batterie incluse | Pen holder with calendar, alarm clock and thermometer, includes battery | Cubilete con reloj, calendario y termómetro. Pila incluida | Porte stylo de table avec horloge-réveil multifonctions, pile incluse
Plastica | Plastic | Plástico | Plastique

9,8 x 11,7 x 7,5 cm 🔋 T8 | UV11 4 x 2 cm 📦 40/80



.01

34005 *pete*

Orologio a pendolo da tavolo, batterie escluse | Table clock pendulum, batteries no included | Mesa de pendulo del reloj. Sin baterias | Pendule de table, pile non incluse
Plastica | Plastic | Plástico | Plastique

12 x 10 x 5,8 cm T8 2 x 1 cm 1/40



.32

34004 *frido*

Orologio da tavolo, fornito con vari quadranti personalizzabili, batterie escluse | Table clock, batteries no included | Reloj por mesa. Sin baterias | Horloge de table, fournie avec divers cadres personnalisables, pile non incluse
Plastica | Plastic | Plástico | Plastique

9,5 x 9,8 x 3,4 cm T8 2 x 1 cm 1/40



.08

.02

32036 *daytona*

Orologio con clip e porta memo | Desk Clock with clip and memo holder | Reloj con clip y porta notas | Horloge + porte mémo
Plastica | Plastic | Plastica | Plastic

9,4 x 9,4 x 2,5 cm T8 UV17 2 x 3 cm 100



.23

daytona

DESKCLOCK



.32



.08

.05

.01

35000 *orla*

Orologio. in barattolo 1 Pila AA/R03 non inclusa | Clock. in a tin 1 Battery AA/R03 not included | Reloj en el tarro. 1 Pila AA/R03 no incluida | Horloge. dans la boîte 1 pile AA/R03 non incluse

Alluminio | Aluminium | Aluminio | Alluminium

5,2 x Ø 8,8 cm T8 3x2 cm 20/80



.08



.23

.02

.01

35055 *marti*

Orologio digitale da tavolo con note clip. Batteria inclusa | Digital table clock with memo click. Button cell batteries included | Reloj digital de escritorio con note clip. Batería incluida | Horloge digitale de table avec clip. Pile incluse
Plastica | Plastic | Plástico | Plastique

5,5 x 8,8 x 2,5 cm T7 4 x 1,5 cm 1/200

METEO STATION SKclock

32027 plus

Stazione meteo, temperatura, Batterie incluse | Weather station, temperature, Batteries included | Estación meteorológica con temperatura, 2 pilas incluidas | Station météo, température, 2 piles incluses
Plastica | Plastic | Plástico | Plastique

11 x 7 x 1,3 cm 🌧️ T8 4 x 2 cm 📦 20/100

.01



.08

.05



32026 cenk

Stazione meteo, temperatura interna ed esterna, 2 batterie AAA/R03 non incluse | Weather station, indoor | outdoor temperature, 2 batteries AAA/R03 not included | Estación meteorológica, temperatura interior/exterior, 2 pilas AAA/R03 no incluidas | Horloge avec station météo, température interne et externe, 2 piles AAA
Plastica | Plastic | Plástico | Plastique

11,6 x 13,5 x 4 cm 🌧️ T8 4 x 1 cm 📦 1/50

.06

.05

.08

cenk



.05

.08

.02

.01

32057 kalos

Orologio da tavolo, 2 Batterie AAA/R03 Non Include | Desk Clock, 2 Batteries AAA/R03 Not Included | Reloj de mesa, 2 pilas AAA/R06 no incluidas | Horloge, 2 Piles AAA/R03 Non Includes
Plastica | Plastic | Plastica | Plastic

11 x 9,2 x 4 cm 🌧️ T8 | UV17 4 x 1 cm 📦 60



.32



.32

32031 norig

Orologio digitale da scrivania | Digital multifunction display with clock | Reloj de escritorio digital | Horloge de bureau numérique.
Plastica | Plastic | Plástico | Plastique

13 x 13 x 2 cm 🌧️ T8 4 x 2 cm 📦 1/50

35022 xenia

Orologio da tavolo con termometro, calendario e sveglia, batterie incluse | Desk clock with thermometer, calendar and alarm, includes battery | Reloj de sobremesa de plástico con alarma, calendario y termómetro. Pila incluida | Horloge de table avec thermomètre, calendrier et réveil, pile incluse
Plastica | Plastic | Plástico | Plastique

5,5 x 11 x 2,8 cm 🌧️ T8 4 x 0,7 cm 📦 1/100

CALCOLATORI

27651 *dipda*

Calcolatrice con 8 cifre, pile incluse | Calculator. Button Batteries Included | Calculadora con pilas incluidas | Calcalatrice, Piles incluses
Plastica | Plastic | Plastica | Plastic

8 x 2,6 x 12,4 cm T7 4 x 1 cm 50/100



.05

.08

.06

.01



.32

24012 *noumea*

Set da ufficio con calcolatrice, righello e penna a sfera | Office set with calculator, ruler and ball pen, supplied in a presentation box | juego de sobremesa incluyendo calculadora, regla y bolgrafo
Metallo | Metal | Metal

17 x 24 x 3,5 cm S86 5 X 5 cm 50/200



.02



.08

.05

38020 *wendi*

Orologio, batteria inclusa | Watch, including battery | Reloj, batería incluida | Montre, pile incluse

Plastica | Plastic | Plástico | Plastique

23,2 x 3,2 x 1,7 cm (box) T8 (silicone part) 3 x 1 cm 50/200



.01

27506 *giuggiole*

Custodia con blocco, calcolatrice | Notepad with block, calculator | Bloc de notes con calculadora | Porte-documents avec bloc notes, calcalatrice
Similpelle | Imitation leather | Polipiel | Similcuir

10 x 15 x 2 cm S3 5 x 5 cm 100



.23

.17

.08

.06

.02



.01

38070 *vision*

Orologio ultrasottile | Ultra Slim Watch. Silicone | Reloj de silicona ultra fino | Montre ultra fine en silicone

Silicone | Silicone | Silicone | Silicone

26 x 4 x 0,3 cm 200



.02

.06

.05

.08

.17



.01

38030 *dehal*

Orologio, pila a bottone inclusa | Watch, button cell included | Reloj, pila botón incluida | Montre, pile incluse

Plastica | Plastic | Plástico | Plastique

23,3 x 4 x 0,8 cm 20/400



.05



.32



.05



.07

.08

27003 *enola*

Calcolatrice 8 cifre, press-up con impugnatura in gomma | Calculator 8 digits with rubber sides and auto folding lid, plastic | Calculadora plegable de 8 digitos | Calcalatrice 8 chiffres flexion avec bords en gomme

Plastica | Plastic | Plástico | Plastique

7,5 x 9,5 x 1,2 cm T7 | UV3 3 x 1,5 cm 100/200

27039 *elki*

Calcolatrice a 8 cifre con convertitore euro | Calculator 8 digits with euro converter | Calculadora 8 digitos y euro convertidor | Calcalatrice 8 chiffres avec convertisseur euro

Plastica | Plastic | Plástico | Plastique

6 x 10,7 x 1,2 cm T7 4 x 1 cm 60/360

27044 *ayta*

Calcolatrice 8 cifre | Calculator 8 digits | Calculadora 8 digitos | Calcalatrice 8 chiffres
Plastica | Plastic | Plástico | Plastique

6 x 11 cm T7 3 x 0,7 cm 20/200



.02



.02



.01



.05



.08 .07

27000 gozzano

Calcolatrice da tavolo | Desk calculator | Calculadora | Calculatrice
Plastica | Plastic | Plástico | Plastique

20 x 10,8 x 3 cm T7 4 x 1 cm 50/100

27004 galliavola

Calcolatrice 8 cifre | Desk calculator, 8 digits | Calculadora |
Calculatrice 8 chiffres

Plastica | Plastic | Plástico | Plastique

11,5 x 5,7 x 1 cm T7 UV3 3 x 2 cm 20/200

27005 palikir

Calcolatrice 8 cifre | Calculator 8 digits | Calculadora 8 digitos |
Calculatrice 8 chiffres

Plastica | Plastic | Plástico | Plastique

11 x 6,3 x 2 cm T7 2 X 1 cm 1/200

27041 labu

Calcolatrice 8 cifre | Calculator 8 digits | Calculadora 8 digitos |
Calculatrice à 8 chiffres

Plastica | Plastic | Plástico | Plastique

10 x 3 x 16 cm T7 3 x 0,7 cm 25/50



.03



.32

27507 magica

Calcolatrice 8 cifre con specchio | Calculator 8 digits with mirror |
Calculadora 8 digitos con espejo | Calculatrice 8 chiffres
Plastica, vetro | Plastic, glass | Plástico, vidrio | Plastique

4,5 x 13 x 1 cm T7 UV3 3 x 2 cm 50/400

27516 patlabor

Calcolatrice convertitore euro e portachiavi | Keyring with calculator and
euro converter | Llavero con calculadora y euro convertidor | Porteclés
avec calculatrice et convertisseur euro

Plastica | Plastic | Plástico | Plastique

8 x 4 x 1 cm T11 UV2 2 x 2 cm 50/300



.08



.05

27510 omusa

Righello 20 cm con calcolatrice 8 cifre | 20 cm ruler with 8 digits calculator
| Regla de 20 cm con calculadora | Règle 20 cm avec calculatrice 8
chiffres

Plastica | Plastic | Plástico | Plastique

20,9 x 5,3 x 0,9 cm T7 5 x 1,5 cm 50/100



.06



.02



.08



.04

27511 kasari

Righello 20 cm con calcolatrice a 8 cifre | 20 cm ruler with calculator |
Regla 20 cm con calculadora | Règle 20 cm avec calculatrice

20,9 x 5,3 x 0,9 cm T7 5 x 1,5 cm 50/200

31016 wilny

Walkman radio, batteria inclusa | Walkman radio, including
battery | Walkman, pila incluida | Walkman radio, pile incluse
Plastica | Plastic | Plástico | Plastique

5,5 x 3,8 x 1,5 cm T7 2 x 1 cm 1/300



.02

31003 lala

Walkman radio, FM, ricerca automatica. Clip in metallo, batterie incluse | FM
autoscan radio with metal belt clip. Batteries included | Radio FM autoscan
de plástico con clip de metal. pila incluida | Walkman radio FM, recherche
automatique. clip en métal, pile incluse

Plastica | Plastic | Plástico | Plastique

10 x 3 x 1,5 cm T7 3 x 1 cm 1/200



.05



.32

27050 quasila

Calcolatrice 8 cifre | Calculator 8-digit dual power | Calculadora 8 digitos |
Calculatrice 8 chiffres avec dual power

Plastica | Plastic | Plástico | Plastique

14,6 x 11 x 3,2 cm T7 3 x 1 cm 50/100

TECHNOLOGY

touch the FUTURE

Power bank, penne a sfera touch con power bank, penne usb e penne con puntatore. USB hub con più porte, supporti per cellulari e ventole. Porta documenti con power bank inclusi, adattatori per auto, auricolari, cuffie e molto altro ...

86 - 147

tecnologia - technology - technologie

stugvik



.02

26241 *stugvik*

Vaso smart con speaker bluetooth | Smart pot with bluetooth speaker |
Plastica | Plastic | Plástico | Plastique

ø 12 x 11 cm S86 4 x 3 cm 1 / 30





VIRTUAL reality



.02



.01



.02



.02



.01

26219 tanzanite

Occhiali Virtuali | Virtual glasses | Verres virtuels | Gafas virtuales
Abs

14 x 12,9 x 20 cm 🌊 T8 6 x 1,5 cm 📦 50

26010 gradara

Occhiali Virtuali | Virtual glasses | Verres virtuels | Gafas virtuales
Plastica | Plastic | Plástico | Plastique

12,8 x 6,7 x 2,2 cm 🌊 T8 6 x 1,5 cm 📦 100

26359 ceratonia

Gamepad
Plastica | Plastic | Plástico | Plastique

3,1 x 7,3 x 1,3 cm 🌊 T8 6 x 1,5 cm 📦 100



26344 gandino

Videocamera sportiva, subacquea fino a 30 mt, risoluzione 720p | Action videocamera, waterproof 30 m, HD 720p | Videocámara deportiva, sumergible hasta 30 m, resolución 720p | Caméra sportive pour plongée jusqu'à 30 m, résolution 720p
Plastica, metallo | Plastic, metal | Plástico, metal | Plastique, métal

12 x 23 x 5,8 cm 🌊 1,2 x 0,6 cm 📦 1 / 20

gandino



26348 *trigun*

Penna a sfera Touch con Power Bank 650 mAh | Ball pen touch screen with Power bank 650 mAh | Boligrafo touch screen con power bank 650 mAh | Stylo à bille avec pointeur tactile avec power bank 650 mAh
Metallo | Metal | Métal

☞ 1,5 x 14,5 cm ☞ T8 3 x 1 cm ☞ 25/100

.01

.02

POWER *bank*

26259 *agara*

Power bank 2400 mAh. Cavo incluso | Power bank 2400 mAh. Cable included | Power bank 2400 mAh. Cable incluido | Powerbank 2400 mAh. Cable inclus

Plastica | Plastic | Plástico | Plastique

☞ 5,9 x 9 x 1 cm ☞ T8 4 x 3 cm ☞ 25 / 100



.01

.02



.02

.06

.05

26333 *kalix*

Power Bank 2.000 mAh. Cavo escluso | Power Bank 2.000 mAh. Cable exclude | Cargabateria, 2.000 mAh. Cable excluido | Chargeur, 2.000 mAh. Câbles exclus

Plastica | Plastic | Plástico | Plastique

☞ 9,7 x 2,3 x 2,6 cm ☞ T8 | UV17 9,4 x 2,2 cm ☞ 25 / 100



.04

.01

.08

.07

.17

2000mAh



.01

.02

.08

.05

.01

.02

26117 *hematite*

Power Bank 2.000 mAh. Cavo escluso | Power Bank 2.000 mAh. Cable exclude | Cargabateria, 2.000 mAh. Cable excluido | Chargeur, 2.000 mAh. Câbles exclus

Plastica | Plastic | Plástico | Plastique

☞ 2,5 x 2,5 x 9 cm ☞ T8 | UV17 9,4 x 2,2 cm

☞ 25 / 100

26232 *giatrus*

Batteria portatile con finizioni gommate con pannello solare e LED. Capacità 4000 mAh. USB/cavo micro USB inclusi. | Portable battery with solar panel and LED. 4000 mAh. Cable included | Power bank 4000 mAh con panel solar y LED. Incluye cable. | Batterie portable avec finitions gommées comprenant panneau solaire et LED. Capacité 4000 mAh. USB/Cable micro-USB inclus.

ABS gommato | ABS, rubber finish | ABS recubierto de goma |

☞ 14,3 x 7,7 x 1,6 cm ☞ T8 2 x 1,5 cm ☞ 100

26057 *quarene*

Power bank 1800 mAh con cavo Micro usb / usb incluso | Power Bank 1800 mAh with USB/micro-USB cable | Power bank 1800 mAh con cable micro usb/usb incluso | Power bank 1800mAh avec cable

Plastica | Plastic | Plástico | Plastique

☞ 9,8 x 6,4 x 0,5 cm ☞ T8 | UV17 5 x 5 cm ☞ 1/100



26368 kurgan 2200 mAh

Unità carica. Cavo USB/micro, USB incluso | Power bank. USB/micro USB cable included | Bateria recargable. Cable USB/micro USB incluido | Chargeur. USB/micro câble USB inclus
Alluminio | Aluminium | Aluminio | Aluminium

9,4 x 2,2 x 2,1 cm T8 9,4 x 2,2 cm 1/100

2200mAh



26341 rabinafis

Power bank 2.200 mAh. | Power bank 2.200 mAh. Cable included | Cargabatería 2.200 mAh.. Cable incluido. | Chargeur 2.200 mAh. Câbles inclus
Plastica | Plastic | Plástico | Plastique

10 x 2,4 x 2,7 cm T8 4 x 1,5 cm 25 / 100



26392 gallichio

Power bank 2200 mAh con ventose | Power bank 2200 mAh | Power Bank 2200 mAh | Power Bank 2200 mAh
Plastica | Plastic | Plástico | Plastique

10 x 2,5 x 3,4 cm T8 6 x 1,5 cm 25 / 100



26388 grignasco

Power bank, 2200 mAh | Power bank, 2200 mAh | Power Bank, 2200 mAh | Power bank, 2200 mAh
Plastica | Plastic | Plástico | Plastique

10 x ø 2,5 cm T8 | UV17 7 x 2 cm 25/100

26340 rapids

Power bank 2.200 mAh. | Power bank 2.200 mAh. Cable included | Cargabatería 2.200 mAh. Cable incluido. | Chargeur 2.200 mAh. Câbles inclus
Plastica | Plastic | Plástico | Plastique

3,2 x 2,5 x 9,6 cm T8 4 x 1 cm 25 / 100



POWERbank



26978 downey

Unità Carica. 2200 mAh. Cavo Incluso | Power Bank. Cable Included | Power Bank con cable incluido | Power Bank
Plastica | Plastic | Plástico | Plastique

9,5 x 2,5 x 2,5 cm T8 6 x 1,5 cm 25 / 100



26403 conatry

Power Bank 2500 mAh e Usb 8 gb | Power bank 2500 mAh with usb 8 gb | Power bank 2500 mAh with usb drive 8 gb
Plastica | Plastic | Plástico | Plastique

6,2 x 11,4 x 8 cm T8 | UV17 7 x 3 cm 25/100



26343 twinkle

Power bank (2600 mAh.) 2 in 1
Alluminio | Aluminium | Aluminio | Aluminium

9,2 x 4 x 2 cm T8 7 x 2 cm 1/100

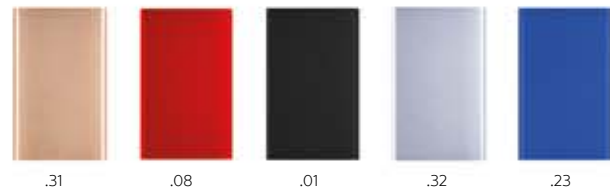

26347 *charoite*

Power bank, 4000 mAh. Cavo USB/micro, USB incluso | Power bank, 4000 mAh. USB/micro USB cable included | Power Bank, 4000 mAh. Cable USB/micro USB incluido | Power bank, 4000 mAh.USB/micro câble USB inclus
Alluminio | Aluminium | Aluminio | Aluminium

11 x 1 x 7 cm T8 7 x 2 cm 100



charoite



26214 *heliotrope*

Power bank 4.000 mAh, cavo incluso | Power Bank 4.000 mAh, cable included | Cargabateria 4.000 mAh, cable incluido | Chargeur 4.000 mAh, câble inclus.
Plastica | Plastic | Plástico | Plastique

9,7 x 4,5 x 2,3 cm T8 | UV17 2 x 2 cm 1/50



4000mAh



26389 *grottolo*

Power Bank 4000 mAh con cavo micro usb/usb | Power bank 4000 mAh, cable included | Power Bank 4.000 mAh, incluye cable | Power Bank 4000 mAh avec cable micro usb/usb
Plastica | Plastic | Plástico | Plastique

10,8 x 3,8 x 1,3 T8 | UV17 9,4 x 2,2 cm 25/100



26332 *rankweil*

Power bank 4.000 mAh. Cable incluido | Cargabateria 4.000 mAh. Cable incluido. | Chargeur 4.000 mAh. Câbles inclus.
Acciaio inox, ABS | Stainless Steel, ABS | Acero inoxidable, ABS | Acier Inox, ABS

11,6 x 1 x 6,5 cm T8 | UV17 5 x 5 cm 50

WIRELESS charger



26236 ekby

Caricatore wireless per smart phone | Wireless charger for smart phone | Cargador wireless para smart phone | Chargeur sans fils pour smartphone
Plastica | Plastic | Plástico | Plastique

☞ 10 x 0,7 cm ☞ T8 Ø 3 cm



26369 mafalda

Power bank 6.000 mAh, cavo incluso | Power Bank 6.000 mAh, cable included | Cargabatería 6.000 mAh, cable incluido | Chargeur 6.000 mAh, câble inclus
Plastica | Plastic | Plástico | Plastique

☞ 9,7 x 6,3 x 2,5 cm ☞ T8 3 x 3 cm ☞ 1 / 50

26235 ektorp

Caricatore wireless 2100 mAh con 2 porte USB | Wireless charger 2100 mAh with 2 USB outputs | Cargador wireless 2100 mAh con 2 puertos USB | Chargeur sans fils 2100 mAh avec 2 port USB
Plastica | Plastic | Plástico | Plastique

☞ 9 x 0,9 x 9 cm ☞ T8 4 x 4 cm



26243 lomviken

Power bank 6000 mAh con 2 uscite USB. Cavo incluso | Power bank 6000 mAh with 2 USB ports. Cable included | Power bank 6000 mAh con 2 entradas USB. Cable incluido | Powerbank 600 mAh avec 2 USB. Cable inclus
Plastica | Plastic | Plástico | Plastique

☞ 8,5 x 8,5 x 2,7 cm ☞ S65 4,5 x 4,5 cm ☞ 1 / 50

26260 bisinia

Power bank con 2 porte d'uscita. 10000 mAh. Cavo escluso | Power bank with 2 USB Outputs. 10000 mAh. Cable Not Included | Power bank con 2 salidas USB. 10000 mAh. Cable No Incluido | Power bank avec 2 Sorties USB. 10000 mAh. Câble Non Inclus
Alluminio | Aluminium | Aluminio | Alluminium

☞ 7,5 x 14,1 x 1,3 cm ☞ T8 3 x 3 cm ☞ 25 / 50

26242 sonso

Power bank 10000 mAh con 2 uscite USB. Cavo incluso | Power bank 10000 mAh with 2 USB ports. Cable included | Power bank 10000 mAh con 2 entradas USB. Cable incluido | Powerbank 10.000 mAh avec 2 USB. Cable inclus
Plastica | Plastic | Plástico | Plastique

☞ 7,4 x 15,4 x 1,6 cm ☞ S65 ☞ 50



gianico

26345 gianico

Menu Power Bank 10000 mAh
Abs
15,5 x 7,5 x 27,5 cm T8 3 x 2 cm 10



10000mAh



26240 idealisk

Powerbank 2200 mAh con cavo e custodia | Powerbank 2200 mAh with cable and pouch | Powerbank 2200 mAh con cable y funda | Powerbank 2200 mAh avec cable et étui
Plastica | Plastic | Plástico | Plastique
4 x 10,5 x 5 cm S3 100

26346 ceropegia

Set di Power bank | Power bank Set 4.000 mAh. | Set Cargabatería | Set de Chargeur
Plastica | Plastic | Plástico | Plastique
15 x 4 x 8,5 cm S3 4 x 2 cm 50/100



Set POWERbank



.01



.24



.02



.08



.04



.07



.05



.06

26210 *mindy*



.02



.02

26900 *lagoon*

Power bank 2000 mAh con adattatore corrente e per auto 2.1A e cavo Micro usb / usb | Power bank set 2.000 mAh with 220V charger, car charger 2.1A and cable | Set de cargabatería 2.000 mAh con cargador 220 V, adaptador para el coche 2.1 mA y cable Micro USB/USB. | Set avec Power bank 2.000 mAh avec chargeur 2.1A et cable
Plastica | Plastic | Plástico | Plastique

11 x 7 x 4,5 cm 3 S3 4 x 2 cm 1/100

26213 *panamaribo*

Set Power bank 2.200 mAh, caricatore USB 2.100 mAh e cavo incluso | Power Bank Set 2.200 mAh, USB car charger 2.100 mAh and cable included | Set cargabatería 2.200 mAh, cargador USB 2.100 mAh y cable incluidos | Set de chargeur 2.200 mAh, chargeur USB 2.100 mAh, et câble inclus Similpelle, plastica
| PU, plastic | Polipiel, plástico | Similicuir, plastique

11,5 x 7,5 x 4 cm 3 S3 4 x 2 cm 1/100

Set POWERbank

26210 *mindy*

Set Power bank 2.200 mAh, caricatore USB 1000 mAh e cavo incluso | Power Bank Set 2.200 mAh, USB charger 1000 mAh and cable included | Set cargabatería 2.200 mAh, cargador USB 1000 mAh y cable incluidos. | Set de chargeur 2.200 mAh, chargeur USB 1000 mAh et cable inclus. Similpelle, plastica | PU, plastic | Polipiel, plástico | Similicuir, plastique

7,5 x 11,5 x 4 cm 3 S3 4 x 2 cm 1/100





85083 *grado*

Lampada USB con 5 LED e 4 HUB | USB with 4HUB and 5 LED |
HUB USB con LED | Lampe USB avec 5 LED et 4 HUB
Plastica | Plastic | Plástico | Plastique

4,5 x 14,4 x 1,6 cm T7 UV3 3 x 1 cm 100/200



26371 *ghemme*

USB hub
Plastica | Plastic | Plástico | Plastique

5,2 x 1,8 cm T7 UV3 3 x 1 cm 50/200



26238 *dyrgrip*

Hub 4 porte usb 2.0 con supporto | 4-port hub, 2.0 usb with support |
Hub 4 enchufes usb 2.0 con soporte | HUB 4 port USB 2.0 avec support
ABS | ABS | ABS | ABS

8,3 x 1,5 x 3 cm T8



26067 *avidur*

Porta USB, 4 porte | 4 ports USB hub | Puerto USB, 4
puertos | Multi-port USB, 4 ports.
Plastica | Plastic | Plástico | Plastique

9,6x2x3 cm T7 3 x 1 cm 50/200



26351 *valiant*

USB hub con 5 porte. USB 2.0 | 5 ports USB Hub. USB 2.0
| Multiplicador USB 5 puertos. USB 2.0 | Hub USB avec 5
portes USB 2.0
Plastica | Plastic | Plástico | Plastique

6,5 x 7,7 x 11 cm T7 UV3 3 x 1 cm 50/100



26982 *durbe*

USB hub con 4 porte. USB 2.0 | 4 ports USB Hub.
USB 2.0 | Multiplicador USB 4 puertos. USB 2.0 | Hub
USB avec 4 portes USB 2.0
Plastica | Plastic | Plástico | Plastique

5 x 4 cm T7 UV3 3 x 1 cm 100/500



26245 *summera*

Hub USB con 4 ingressi | Hub USB with 4 ports | Hub USB con 4 entradas | Hub USB avec 4 ports
Plastica | Plastic | Plástico | Plastique

S65 UV8

56897 *prescott*

Ventilatore con USB | Miniature Fan | Ventilador mini | Mini ventilateur
Plastica | Plastic | Plástico | Plastique

14,7 x 15 x 9,5 cm T8 Ø 3 cm 40

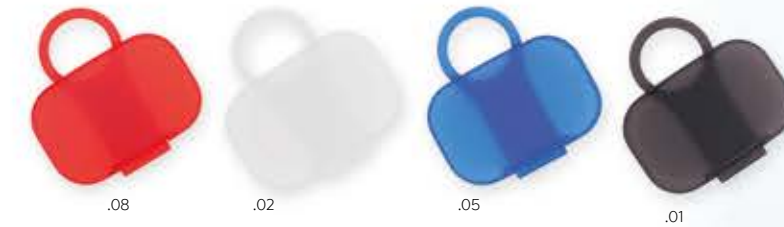

26137 *gadsden*

Supporto per cellulare | Mobile phone holder | Soporte para portátil | Support pour portable
Plastica | Plastic | Plástico | Plastique

9 x 9,5 x 6 cm T6 2 x 2 cm 50/500



technology
104

29183 *adhara*

Supporto per cellulare | Mobile Phone Holder | Soporte para el móvil | Support pour téléphone portable
Plastica | Plastic | Plástico | Plastique

8 x 2,8 x 8 cm T6 3 x 1,5 cm 500

adhara



technology
105

26330 *lule*

Hub Usb con 4 porte | 4 Ports USB hub 2.0 | Hub USB de 4 puertos, USB 2.0 | Hub 4 Portes USB 2.0
Plastica | Plastic | Plástico | Plastique

4 x 5,4 x 5,4 cm T7 | UV3 3,5 x 3,5 cm 50 / 200



26193 *yantarny*

Hub con 4 porte usb 2.0 | HUB with 4 usb 2.0 | HUB with 4 usb 2.0 | HUB avec 4 ports USB 2.0
Alluminio | Aluminium | Aluminio | Aluminium

9 x 4 x 2,5 cm T8 5 x 1 cm 200

grassobbio



.01

62059 grassobbio

Porta documenti con 20 fogli inclusi e powerbank 5000 mAh (Cavo incluso) | A4 folder with power bank 5000 mAh. Cable included and notepad. | Portadocumentos A4 con power bank 5000 mAh. Cable y bloc-notas incluido. | Porte-document avec 20 feuilles incluses et power bank 5000 mAh (Cable inclus) | Similpelle | Imitation leather | Polipiel | Simili-cuir

26,5 x 34 x 4,5 cm S3 | H2 | L15 5 x 5 cm / 2 x 0,8 cm



.01

26239 hejsan

Oscurante per webcam adesivo | Webcam blocker with adhesive | Bloqueador de cámara web adhesivo | Adhésif obscurant pour webcam

Plastica | Plastic | Plástico | Plastique

4,1 x 1,6 x 0,2 cm S86



.02



.03



.01



62073 nordli

Portablocco notes con power bank 3000 mAh. Cavo Incluso | Notepad holder with power bank 3000 mAh. Cable Included | Bloc power bank 3000 mAh con cable incl. | Porte documents avec bloc notes et power bank 3000 mAh. Câble inclus

Similpelle | PU | Polipiel | PU

17,5 x 22,5 x 2,5 cm 6 x 6 cm 20

.01

40155 gessopelena

Quaderno con copertina rigida con USB 8 gb. 80 fogli. Chiusura con elastico | Notepad, hardcover with 8 gb USB. 80 sheets | Bloc de notas con USB 8gb (80 hojas) | Carnet avec USB 8 gb (80 feuilles)

Similpelle | Imitation leather | Polipiel | Similicuir

13,7 x 21 cm S2 | H1 5 x 5 cm 24



.08

.01

.02

.05





29182 *australis*

Pulisci schermo | Screen Cleaner. Microfiber | Limpia pantallas de microfibra | Nettoyeur d'Écran.
Microfibre | Microfibra | Microfibre | Microfibre | Microfibre

3 x 3 cm S1 2 x 2 cm 5000



26386 *galeata*

Adattatore da viaggio universale con dual USB | Universal adapter plug | Adaptador de enchufe universal | Adaptateur de voyage universel avec 2 USB
Plastica | Plastic | Plástico | Plastique

15,5 x 5 x 3 cm T8 2 x 1 cm 10/60

26246 *lugga*

Caricatore USB pieghevole | USB charger retractile | Cargador USB retráctil | Chargeur USB pliable
Plastica | Plastic | Plástico | Plastique

5,9 x 5,9 x 3,9 cm S8 100



26100 *gullan*

Puliscschermo | Screen cleaner | Limpiador de pantalla | Nettoyant d'écran
Plastica | Plastic | Plástico | Plastique

8 x 7 x 2 cm T6 4 x 1,5 cm 50 / 300



26078 *elvy*

Puntatore touchscreen con puliscschermo | Touchscreen pointer with screen cleaner | Puntero táctil con limpiador de pantalla | Pointeur tactile avec nettoyant d'écran
Plastica | Plastic | Plástico | Plastique

6,2 x 3 x 1,2 cm T6 3 x 1 cm 50 / 500



95013 *greta*

Guanti touchscreen | Touchscreen gloves | Pantalla táctil guantes | Gants pour écran tactile
Acrilico | Acrylic | Acrílico | Acrylique

Taglia unica | One size TR23 | LA 4 x 3 cm 200



85038 shelkovo

Lampada USB | USB lamp | USB lamp | Lampe USB
Plastica | Plastic | Plástico | Plastique

1,8 x 16,8 x 1 cm 💧💧 T7 3 x 1 cm 📦 200

USB lamp



26113 rufio

USB 2.0 e lettore cards | USB 2.0 and card reader | USB 2.0 y lector tarjetas | Lecteur carte mémoire USB 2.0
Plastica | Plastic | Plástico | Plastique

5,7 x 4 x 1,5 cm 💧💧 T7 2 x 1 cm 📦 100/600



26393 goro

Adattatore per 5 prese jack | Hub with 5 ports for jack connection | Soporte móvil con 5 conectores jack | Support pour téléphone avec prises pour 5 casques
Plastica | Plastic | Plástico | Plastique

6,5 x 4,5 cm 💧💧 T7 2 x 1 cm 📦 50/500



85086 gaby

Flash aggiuntivo per cellulari. | Additional flash for mobile phone | Flash para móvil | Flash additionnel pour portable.
Plastica | Plastic | Plástico | Plastique

4 x 4 cm 💧💧 T7 2 x 1 cm 📦 50/200



26081 *elly*

Carica batteria da auto | USB Car Charger | Carga batería de coche | Chargeur Voiture USB
Plastica | Plastic | Plastica | Plastic

5,4 x Ø 2,3 cm T7 2 x 1 cm 500

USB CAR charger

26216 *load*

Carica batteria da auto 2100 mAh | USB Car Charger 2100 mAh | Carga batería de coche 2100 mAh | Chargeur Voiture USB 2100 mAh
Plastica | Plastic | Plastica | Plastic

6,2 x 3,2 cm T7 1,5 x 0,6 cm 50/500



26122 *placidus*

Carica batteria da auto con Usb 2100 mAh | USB Charger for car. 2100 mAh | Cargador para el coche con USB 2100 mAh | Chargeur Voiture USB. 2100 mAh
Plastica | Plastic | Plastica | Plastic

2,6 x 3,7 x 8 cm T7 UV3 2 x 1 cm 500



26396 *carnelian*

Portachiavi con caricatore da auto | Keyring with car charger. | Llavoro con cargador para el coche | Portecleé avec chargeur pour voiture
Plastica | Plastic | Plástico | Plastique

5 x 2,5 x 1,5 cm T6 UV2 2 x 1,5 cm 1/500



26123 *wezen*

Set Caricatori USB in astuccio | USB Charger Set in case. | Set de cargadores USB en estuche | Set Chargeurs USB.
Plastica | Plastic | Plástico | Plastic

6 x 3,5 x 7,5 cm S3 4 x 2 cm 200

26247 *mackapär*

Caricatore USB per auto | USB charger for car | Cargador USB de coche | Chargeur USB pour auto
Plastica | Plastic | Plástico | Plastique

3,9 x 7,2 x 5,1 cm S8 200

WI-FI camera



30012 *chalcedony*

Telecamera Wi-fi con altoparlante e microfono. Compreso cavo di ricarica USB | Wi-fi camera with speaker and microphone. Including USB charging cable | Appareil photo Wi-fi avec haut-parleur et d'un microphone. Câble de chargement USB compris | Cámara wi-fi con altavoz y micrófono. Cable de carga USB incluida
Plastica | Plastic | Plástico | Plastique

8 x 11,4 x 8,5 cm 🌊 T8 3 x 1 cm 📦 1/20



.02

26248 *molger*

Telecamera smart. Cavo incluso | Smart camera. Cable included | Cámara inteligente. Cable incluido | Caméra smart avec cable inclus
Plastica | Plastic | Plástico | Plastique

11 x 7 cm 🌊 S8 2,5 x 2 cm 📦 20



83102 *måla*

Lampada LED. 4 batterie AA non incluse | LED lamp. 4 AA batteries not included | Lámpara LED. 4 pilas AA no incluidas | Lampe LED. 4 piles AA non incluses
Plastica | Plastic | Plástico | Plastique

24 x 13 cm 📦 20





49064 miller

Tappetino mouse portafoto. Foto: 15 x 10 cm | Mousepad Photo Frame. PVC/ EVA. Photos Size: 15 x 10 cm | Alfombrilla de ratón con portafoto para foto de 15x10 cm | Tapis Souris Porte Photo. PVC/ EVA. Photos: 15 x 10 cm
PVC/EVA

23 x 18 x 0,5 cm S2 5 x 1 cm 400



29051 casey

Tappetino mouse | Mouse pad | Alfombrilla de raton | Tapis pour souris
Tessuto | Fabric | Tessuto | Tissu

24 x 22 x 0,5 cm S2 4 x 4 cm 25/200



26339 derby

Cavo USB/Micro USB, 1 mt con custodia | 1 m USB/Micro USB cable with pouch | Cable USB/Micro USB de 1 m con funda | Câble USB/Micro USB de 1 m avec pochette
Nylon | Nylon | Nailon | Nylon

8,5 x 14 cm S93 5 x 5 cm 500



29256 ekedalen

Tappetino mouse | Mousepad | Alfombrilla | Tapis de souris
Microfibra | Microfiber | Microfibra | Microfibre

22 x 18 cm SP1 22 x 18 cm



29092 franke

Tappetino mouse | Mousepad | Alfombrilla | Tapis de souris
Poliestere/EVA

22 x 18 x 0,15 cm SP1 22 x 18 cm 50/250



26220 ginguiser

Caricatore USB | USB charger. | Cargador USB | Chargeur USB
Plastica | Plastic | Plástico | Plastique

4,8 x 3,5 x 1,4 cm T6 | UV2 2 x 1 cm 1/500



26226 turquoise

Plug Usb 2 porte
Abs

4 x 8 x 2,5 cm T6 | UV2 3 x 2 cm 1/500



26362 *dobele*

Cavo USB/Micro USB, 3 mt con custodia | 3 m USB/Micro USB cable with pouch | Câble USB/Micro USB de 3 m avec pochette
PUC/CU

8,5 x 14 cm S93 5 x 5 cm 400



26258 *maubois*

Bracciale caricabatteria con connessione Micro USB | Braciale charger with Micro usb connection | Pulsera cargador con conexion micro usb | Chargeur bracelet avec connexion micro Usb
Alluminio/ TPE | Aluminium / TPE | Aluminio /TPE | Alluminium / TPE

22 x 1,2 x 0,8 cm 50/300



26089 *klas*

Puntatore laser. Batterie incluse | Laser pointer. Batteries included | Puntero láser. Pilas incluidas | Pointeur laser. Batteries incluses.
Plastica | Plastic | Plástico | Plastique

9,7 x Ø 1,5 cm T8 2 x 0,7 cm 50/1000



26237 *grundtal*

Caricatore 6800 mAH con 4 porte USB. Cavo incluso | Charger 6800 mAH with 4 USB ports. Cable included. | Cargador 6800 mAH con 4 salidas USB. Cable incluido | Chargeur 680 mAH avec 4 port USB. Cable inclus
Plastica | Plastic | Plástico | Plastique

15,5 x 7,8 x 12,7 cm T8



26876 *new york*

Scalda tazza | Mug warmer | Calentador de taza | Chauffe tasse.
Plastica, metallo | Plastic, Metal | Plástico, Metal | Plastique, métal

Ø 9 x 2 cm T8 3 x 1,5 cm 1/100



26119 *rioverde*

Cavo adattatore | Wire adaptor. Connections: Micro USB and Apple Devices | Cable adaptador Micro USB y Disp. Apple | Chargeur connexions Micro USB et Dispositifs Apple
Plastica | Plastic | Plástico | Plastique

27 cm T6 0,5 x 0,5 cm 200/400

rioverde



26135 *lucio*

Lettore SMART CARD, (card escluse) | SMART card reader (card not included) | Lettor de tarjetas SMART, tarjetas no incluidas | Lecteur SMART CARD, carte non incluse
Plastica | Plastic | Plástico | Plastique

8 x 6 x 0,9 cm T8 2 x 2 cm 25/100

gragnano



26387 gragnano

Portachiavi con auricolari | Earphones with keyring | Auriculares con llavero | Portclés avec écouteurs
Plastica | Plastic | Plástico | Plastique

7,5 x 4 x 2 cm T7 3 x 2 cm 50/200



26230 dunham

Auricolari | Earphones | Auriculares | Écouteurs
Plastica | Plastic | Plástico | Plastique

5,5 x 5,8 x 2,1 cm T7 UV2 Ø 4,5 cm 50/200

26204 gerace

Auricolari con microfono | Earphone with microphone | Casco con microfono | Ecouteurs avec micro
Plastica | Plastic | Plástico | Plastique

7 x 7 x 2 cm T7 UV3 4 x 4 cm

50/250



26397 diaspore

Auricolari con supporto per cellulare. | Earphone with box and phone holder. | Auriculares con estuche y soporte para móvil | Ecouteurs avec support pour mobile.
Plastica | Plastic | Plástico | Plastique

Ø 6,8 cm T7 UV2 Ø 4 cm 50/200



26160 ontario

Auricolari | Set auriculares jack 3,5 mm | Écouteurs dans boîte en plastique avec prise jack 3,5mm
Plastica | Plastic | Plástico | Plastique

6,5 x 1,7 x 6,1 cm T7 UV3 2 x 2 cm 50/500



.02

26046 donny

Auricolari con connessione Jack 3,5 mm. Con custodia e supporto per cellulare | Earphones with 3,5 mm Jack connection in case with mobile phone stand | Auriculares con conexión Jack 3,5 mm. Con caja y soportes de telefonía móvil | Écouteurs avec connexion Jack 3,5 mm. Avec étui et supports pour téléphonie mobile.

Plastica | Plastic | Plástico | Plastique

9 x 7,5 x 2 cm | T6 | UV9 3 x 2 cm | 50/200



.07



26198 sosnovka

Auricolari con microfono | Earphones with microphone | Earphones with microphone | Écouteurs avec micro
Abs | Abs | Abs | Abs

7 x 7 x 3 cm | T7 | UV3 4 x 4 cm | 500



.02

.01

26086 hanna

Cuffie retraibili | Retractable earphones | Auriculares retráctiles | Écouteurs rétractants

Plastica | Plastic | Plástico | Plastique

2,5 x 3,8 x 1,1 cm | S93 | T7 Ø 1 cm | S3 2 x 2 cm | 100/200



26093 cigala

Auricolari con connessione Jack 3,5 mm, con custodia | Earphones with 3,5 mm Jack connection, in box | Auriculares con conexión Jack 3,5 mm, en cajita | Écouteurs avec connexion Jack 3,5mm, avec emballage
Plastica | Plastic | Plástico | Plastique

7 x 7 x 2 cm | T7 | UV3 4 x 4 cm | 20/500



.23



.17



26197 vytegra

Auricolari con connessione Jack 3,5 mm | Earphones with jack | Earphones with jack | Écouteurs avec connexion Jack 3,5mm.
Plastica | Plastic | Plástico | Plastique

8 x 7,8 x 1,2 cm | 500



26249 *malm*

Auricolari bluetooth ricaricabili con USB. Cavo incluso | Rechargeable bluetooth earphones with USB. Cable included | Auriculares bluetooth recargables con USB. Cable incluido | Écouteurs bluetooth rechargeables avec USB. Câble inclus
Plastica | Plastic | Plástico | Plastique

🔋 S8



26251 *landskrona*

Auricolari bluetooth ricaricabili con USB. Cavo incluso | Bluetooth earphones. USB rechargeable. Cable included | Auriculares bluetooth recargables con USB. Cable incluido | Écouteurs bluetooth rechargeables avec USB. Cable inclus
Plastica | Plastic | Plástico | Plastique

📏 5 x 7 x 3 cm 🔋 S8 📦 200



26217 *galatro*

Auricolari | Earphones | Auriculares | Écouteurs
Plastica | Plastic | Plástico | Plastique

📏 11,2 x 3,2 x 19,5 cm 📦 50/200



26250 *volpe*

Auricolari wireless per fare sport | Wireless headphones 3.0 for sports | Auriculares wireless para practicar deporte | Écouteurs wireless sport
Plastica | Plastic | Plástico | Plastique

📏 Ø 8 x 2,5 cm 🔋 S8 3 x 3 cm 📦 100

WIRELESS sound



.08



.23

.01

.02

26252 långfjäll

Auricolari bluetooth o connessione jack ricaricabili con USB. Cavo incluso | Bluetooth earphones or jack connexion USB rechargeable. Cable included | Auriculares bluetooth o conexión jack, recargables con USB. Cable incluido | Écouteurs bluetooth avec connexion jack rechargeables avec USB. Cable inclus
Plastica | Plastic | Plástico | Plastique

18 x 18,5 x 7,8 cm 185 L5 20



.01



.02

.08

.01



26199 gorodets

Cuffie con cavo | Headphones | Headphones | Casque avec cable
Plastica | Plastic | Plástico | Plastique

Ø 6 cm 185 T8 3 x 2 cm 100



.01

.08

.05

26118 dubhe

Auricolari. Connessione Jack 3,5 mm | Earphones. 3,5 mm Jack Socket | Auriculares con conexión Jack 3,5 mm | Écouteurs. Connexion Jack 3,5 mm
Plastica | Plastic | Plástico | Plastique

16 x 18 x 5,5 cm 185 T8 5 x 1 cm 20



.02



.01

.02

26183 *alvdal*

Altoparlante ad induzione | Induction speaker | Altavoz a induccion | Haut-parleur a induction
Plastica | Plastic | Plastico | Plastique

12,5 x 3,8 x 6,8 cm T8 4 x 2 cm 100



.02



.19

.08

.01



.08

26400 *ghedi*

Speaker resistente all'acqua, bluetooth | Waterproof speaker bluetooth | Speaker bluetooth | Haut-parleurs
Abs | Abs | Abs | Abs

8,4 x 5 cm T8 2,5 x 0,8 cm 50/100

31005 *bogorodsk*

Speaker bluetooth con moschettone | Speaker bluetooth | Speaker bluetooth | Haut-parleurs avec mousqueton
Abs | Abs | Abs | Abs

8 x 5 cm T8 2,5 x 0,8 cm 150



.01



.02

.32

.08

.05



.02



.08

.06

.05

.04

.02

.07

.17

.01

26190 *sherpi*

Cassa audio bluetooth | Bluetooth Speaker | Altavoz con Bluetooth | Haut-parleur Bluetooth
Plastica | Plastic | Plástico | Plastique

7,5 x 6 cm T8 2 x 2 cm 50



.01

.02

26004 *gorzegno*

Torcia con speaker bluetooth | Flashlight with bluetooth speaker | Linterna con altavoz bluetooth | Lampe torche avec haut parleur et bluetooth
Plastica | Plastic | Plástico | Plastique

15 x 3,5 cm T8 2 x 2 cm 10/60



30004 *damasco*

Cassa bluetooth ricaricabile | Bluetooth Speaker, usb rechargeable | Altavoz bluetooth recargable | Haut-Parleur bluetooth rechargeable
Metallo | Metal | Metal | Métal

5,9 x 5 cm T8 3 x 2 cm 1/50



26989 *virve*

Cassa audio bluetooth 3W | Bluetooth speaker 3W |
Altavoz inalámbrico 3W | Haut parleur bluetooth 3W
Metallo | Metal | Metal | Métal

☞ Ø 7 x 4,2 cm ☞ T8 3,5 x 1,5 cm ☞ 50



.31



26201 *apiai*

Mini cassa audio bluetooth con laccetto | Mini bluetooth speaker
with lanyard | Mini altavoz con bluetooth y lanyard | Mini haut-parleur
bluetooth avec lanyard
Plastica | Plastic | Plástico | Plastique

☞ 5,5 x 5,5 x 4,5 cm (box) 2,5 x 2,5 x 3 cm (item)
☞ S3 | T8 | UV3 3,5 x 2,5 cm (box) 1,5 x 1,5 cm (item) ☞ 150/200

.02



.01



.23

.02

.01

.08

26349 *upptäcka*

Cassa audio bluetooth 4.2 + EDR. Micro SD, radio with 300 mAh battery |
Speaker bluetooth 4.2 + EDR. Micro SD, radio. Battery 300 mAh | Altavoz
bluetooth 4.2 + EDR. Micro SD, radio con batería de 300 mAh | Haut
parleur bluetooth 4.2 + EDR. Micro SD, radio avec batterie 300 mAh
ABS | ABS | ABS | ABS

☞ 18 x 18,5 x 7,8 cm ☞ T8 2 x 1,5 cm ☞ 40

26253 *lantliw*

Cassa audio bluetooth con ventose | Bluetooth speaker with suckers |
Altavoz bluetooth con ventosas | Haut parleur bluetooth avec ventouse
Plastica | Plastic | Plástico | Plastique

☞ 6 x 6,9 x 5,8 cm ☞ T11 ☞ 50



.01

26224 *kamenka*

Lenti ottiche universali per smartphone | Camera lens for smartphone |
Camera lens for smartphone | Objectif photo pour smartphone
Plastica | Plastic | Plastico | Plastique

☞ 9,5 x 13,7 x 2,5 cm ☞ S93 4 x 4 cm ☞ 100



.02

30065 *galatina*

Cassa audio bluetooth e power bank 4200 mAh | Bluetooth
Speaker with power bank 4200 mAh | Altavoz con Bluetooth y
power bank 4200 mAh | Haut-parleur Bluetooth avec power bank
4200 mAh

Plastica | Plastic | Plástico | Plastique
☞ ø 4,4 x 10 cm ☞ T8 2 x 2 cm ☞ 50



26361 giakarta

Mouse wireless | Wireless mouse | Ratón óptico inalámbrico | Souris sans fil
Abs | Abs | Abs | Abs

5,5 x 8 x 3,5 cm T8 2,5 x 2,5 cm 100



26194 izborsk

Mouse ottico USB | Optical USB mouse | Optical USB mouse | Souris optique USB
Abs | Abs | Abs | Abs

9,5 x 5,5 x 3 cm T8 2,5 x 2,5 cm 100



26072 dagny

Mouse wireless | Wireless mouse | Ratón óptico inalámbrico | Souris sans fil
ABS

5,7 x 11,3 x 2 cm T8 | UV17 3x3 cm 100



26080 lilia

Mouse ottico ed ergonomico | Optical and ergonomic mouse | Ratón óptico y ergonómico | Souris optique et ergonomique
Plastica | Plastic | Plástico | Plastique

9,4 x 3,3 x 5,2 cm T8 3 x 1,5 cm 1/50



26147 saiph

Mouse a forma di macchina | Mouse | Ratón en forma de coche | Souris en forme de voiture
Plastica | Plastic | Plastica | Plastic

11 x 5,5 x 3 cm T8 2 x 1,5 cm 100



26188 quebec

Mouse senza fili | Wireless mouse | Ratón inalámbrico | Souris san fil
Plastica | Plastic | Plástico | Plastique

2,4 x 5,7 x 11,2 cm T8 | UV17 3x3 cm 100/200



26366 flors

Mini mouse, cavo estendibile | Mini mouse with extensible cable | Minirratón, cable extensible | Mini souris USB, câble rentrant
Plastica | Plastic | Plástico | Plastique

8 x 2 x 3,5 cm T8 2 x 2 cm 50/200



26144 *baltimora*

Glowing slate with USB (USB hub) and watch | Pizarra luminosa con USB (con hub USB) y reloj | Ardoise lumineuse avec usb (avec hub usb) et horloge
Plastica | Plastic | Plástico | Plastique

14,5 x 12,5 x 3,9 cm T8 UV18 4 x 1 cm 1/50



26370 *mork*

Tastiera bluetooth ricaricabile | Bluetooth keyboard, usb rechargeable | Teclado bluetooth recargable | Clavier bluetooth rechargeable
Plastica | Plastic | Plástico | Plastique

20 x 12,5 x 0,6 cm T8 3 x 1 cm 1/50



26254 *lattjo*

Supporto magnetico per smart phone per l'auto | Magnetic smart phone holder for car | Soporte magnético para smart phone para el coche | Support magnetique pour smartphone pour auto
Alluminio | Aluminium | Aluminio | Alluminium

3 x Ø 3,3 cm S5 200



26026 *tokyo*

Hub 4 porte con portapenne | Pen holder with 4 ports hub | Hub para 4 puertos | Hub 4 ports - Printed graphics can be put inside the 2 walls
Plastica | Plastic | Plástico | Plastique

10,5 x 8 x 8 cm T8 DP5 3 x 1 cm 24 x 8 cm 1/36

26008 *leon*

Set computer con mouse, hub 4 porte 1,1, auricolare, 2 cavi USB e 1 cavo di rete, in astuccio | Computer pack with mouse, 4ports 1.1 hub, earphone, 2 USB cables and 1 net extension in case | Kit para el ordenador con 1 ratón, hub 4 puertos 1,1, auricular, 2 cables USB y 1 cable de red | Ensemble ordinateur avec souris, 4 ports USB 1,1, écouteurs, 2 cables USB et 1 cable de réseau, dans étui
Nylon

14,5 x 14 x 4,5 cm S87 5 x 5 cm 1/40



.23 .06 .02

25256 leka

Pulisci schermo. Liquido non incluso | Screen cleaner. Liquid not included | Limpiapantallas. Liquido no incluido | Nettoyeur d'écran. Liquide non inclus
Plastica | Plastic | Plástico | Plastique

2,7 x 8,8 x 2,7 cm 400



.08



.04 .06 .05 .08 .02

41091 lunevo

Custodia multiuso e support | Mobile phone pocket and holder | Funda y soporte para móvil | Pochette multi-fonctions et support
Silicone | Silicone | Silicona | Silicone

5,6 x 9,5 x 0,5 cm S94 3 x 1 cm 100/500



.17



.02

.01



.01

41092 greensboro

Custodia per iPhone 6 Plus | iPhone 6 Plus case | Funda iPhone 6 Plus | Etui iPhone 6 Plus
Plastica | Plastic | Plástico | Plastique

15,8 x 8 cm T7 4 x 4 cm | UV17 12,7 x 6 cm 500



.05

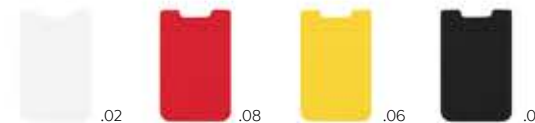

.02 .08 .06 .01

41357 stange

Custodia per I-Phone | Cover for I-Phone | Funda por I-phone | Funda pour I-phone
Similpelle | Imitation leather | Polipieli | Simili-cuir

12 x 6,3 x 1,5 cm S3 | UV3 | H3 4 x 3 cm 120



.21



.02 .08 .04 .18



.32



.02



.08 .05 .07 .04 .01



.08 .05

47068 ewa

Puntatore touchscreen | Touchscreen pointer | Puntero táctil | Pointeur tactile
Plastica, Metallo | Plastic, Metal | Plástico, Metal | Plastique, Métal

3,1 cm T23 | UV1 2 x 0,7 cm 50 / 1000

47112 mimosa

Penna con puntatore touch e puliscschermo | Touch Screen Pen and Screen Cleaner | Bolígrafo con puntero y limpia pantallas | Stylo stylet. Nettoyeur d'Écran Inclus
Plastica | Plastic | Plastica | Plastique

10,5 x Ø 3 cm T7 3 x 0,5 cm 1000

26125 gamma

Custodia multiuso | Multipurpose Pouch | Guarda todo | Pochette Multi-Fonctions
Silicone | Silicone | Silicone | Silicone

5,6 x 8,9 x 0,5 cm S94 3 x 3 cm 1000

41082 jarray

Custodia per iPhone 5 | iPhone 5 holder | Porta iPhone 5 | Porte iPhone 5
Plastica | Plastic | Plástico | Plastique

12,7 x 6 x 1 cm T7 4 x 4 cm | UV17 12,7 x 6 cm 100 / 200

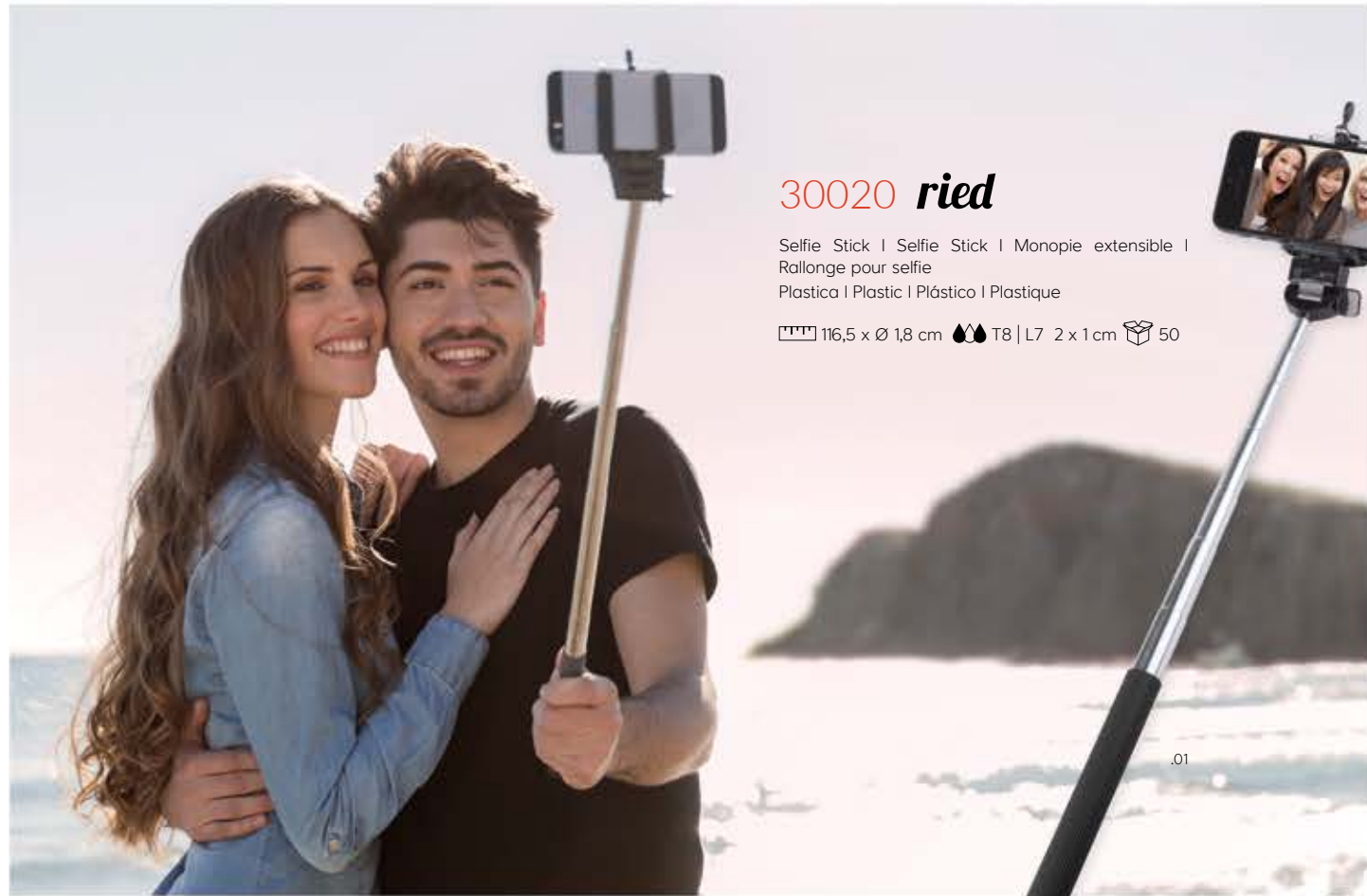

30020 ried

Selfie Stick | Selfie Stick | Monopie extensible |
Rallonge pour selfie
Plastica | Plastic | Plástico | Plastique

116,5 x Ø 1,8 cm T8 | L7 2 x 1 cm 50



.01

SELFIE STICK



.05 .08 .01



.19 .06 .07 .08
.17 .23 .01

30006 consolida

Selfie Stick con power bank | Selfie Stick with power bank | Monopie
estensibile con power bank | Rallonge pour selfie avec power bank
Alluminio | Aluminium | Aluminio | Aluminium

Ø 2,2 x 69 cm T8 | L 2 x 1 cm 50

30022 hovsta

Selfie stick con jack 3,5mm. 7 posizioni | Selfie stick with 3,5mm jack conection. 7
positions | Palo de selfie con conexión jack 3,5mm. 7 posiciones | Perche à selfie
avec prise jack 3,5mm. 7 positions
Acciaio inox | Stainless steel | Acero inoxidable | Acier inox

60 x Ø 2,60 cm T8 100



.08



.08



.17 .02
.05 .08
.06 .04
.07 .01

30003 gushcha

Selfie stick | Selfie stick | Selfie stick | Selfie stick
Acciaio inox | Stainless Steel | Acero inoxidable | Acier
Inox

2,5 x 108 x 2,5 cm T8 | L7 2 x 1 cm 50

30021 rock

Selfie Stick con interruttore | Selfie Stick with button
| Monopie extensible con click | Rallonge pour selfie
avec intereucter
Plastica | Plastic | Plástico | Plastique

116,5 x Ø 1,8 cm T8 | L7 2 x 1 cm 50



.01 .05 .06 .02

Sb
stock



.19



.05



.23

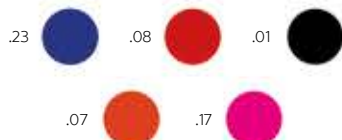

26054 *mordillo*

2gb | 4gb | 8gb | 16gb

💧 L20 2,3 x 1,3 cm

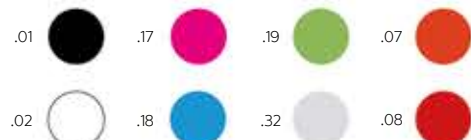

26037 *quan*

2gb | 4gb | 8gb | 16gb

💧 L20 2,3 x 1,3 cm



26349 *vamhes*

2gb | 4gb | 8gb | 16gb

💧 L20 2,3 x 1,3 cm

USB wood



.11

26257 *överflöd*

USB con astuccio | USB in a box | USB con estuche | USB avec étui |

2gb | 4gb | 8gb | 16gb

💧 L20



.11

26234 *kallax*

USB twister | USB twister | USB twister | USB twister

2gb | 4gb | 8gb | 16gb

Bambù | Bamboo | Bambú | Bambou

📏 6,4 x 1,8 x 1,20 cm 💧 L20



.11

26984 *quick*

2gb | 4gb | 8gb | 16gb

💧 L20 2,3 x 1,3 cm

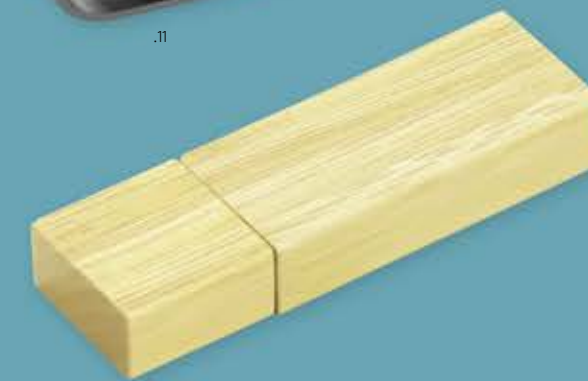

.11

26028 *roby*

2gb | 4gb | 8gb | 16gb

💧 L20 3,5 x 1,4 cm



26024 *dati*

Penna con puntatore touch e usb da 8GB |
Touchscreen ballpen with usb for 8GB |
Boligrafo con puntero táctil con usb de 8GB |
Stylo à bille avec pointeur tactile avec usb de 8GB.
Alluminio | Aluminium | Aluminio | Alluminium

36 x 32 x 18 cm L20 4 x 0,5 cm 1/100

Technology
142



TOUCHSCREEN *usb*



.08 .01 .02 .05

26030 *olarevo*

2gb | 4gb | 8gb | 16gb

L20 3,5 x 0,7 cm (penna) / 6 x 2,5 cm (box) 1/100



LOST&FOUND

.02

- Parking Site Searching, Voice Recording, Self-Portrait, Anti-lost, Find stuff
- Bluetooth 4.0 Low Energy consumption.
- Working distance: 25m.

26195 tazmania

Lost&Found
Plastica | Plastic | Plástico | Plastique

3,1 x 5,2 x 1,1 cm T7 2 x 1 cm 50/200



.02

26102 creditcard

2gb | 4gb | 8gb | 16gb

S3 4,5 x 2 cm | UV3 5 x 8 cm



.32

26087 blake

2gb | 4gb | 8gb | 16gb

L20 2 x 0,9 cm



.01

26986 lux

2gb | 4gb | 8gb | 16gb

L20 2,5 x 1 cm | 2 x 1,5 cm



.01

26025 tarusa

2gb | 4gb | 8gb | 16gb

L20 2 x 2 cm



.01

.08

.01

38019 poochie

Smartwatch | Smartwatch | Smartwatch | Smartwatch

Plastica | Plastic | Plástico | Plastique

4,1 x 5,54 cm S87 | UV14 20

38022 albolack

Smartwatch | Smartwatch | Smartwatch | Smartwatch

Plastica | Plastic | Plástico | Plastique

20

38017 koloksha

Smartwatch | Smartwatch | Smartwatch | Smartwatch

Plastica | Plastic | Plástico | Plastique

4,1 x 5,54 cm S87 | UV14 20



.01

.23

.19

.02

With SIM/ TF card (128M + 64M, up to 32GB) * 1.54" capacitive LCD IPS screen, 240X240 pixel * Bluetooth 3.0 * 1.3M mega pixel camera * G-sensor * MP3, MP4, AVI, bluetooth music playing * Phone calls * Sync QQ, whatsApp, skype, MSN, wechat, SMS etc. between watch and phone (APP installed only suitable for Android) * Call function

	Heart Rate Monitor	Pedometer	Blood Pressure Monitor	Blood Oxygen Monitor	Calls Reminder	Anti lost	Time & Date	Message Notify	Alarm	Calories Counter	Sleep Monitoring	Chronometer	Vibration	Remote Shutter
lillabo 38037	✓	✓	✓	✓	✓	✓	✓	✓	✓	✓	✓	✓	✓	✓
liatorp 38036	✓	✓			✓	✓	✓	✓		✓	✓	✓	✓	✓
cove 32041		✓					✓			✓				
albotack 38022		✓			✓	✓	✓			✓	✓		✓	✓
poochie 38019	✓	✓	✓	✓	✓	✓	✓	✓	✓	✓	✓	✓	✓	✓
koloksha 38017	✓	✓	✓	✓	✓	✓	✓	✓	✓	✓	✓	✓	✓	✓



“
Orologio intelligente
multilingue
bluetooth
•••••
Vibrazione
Aviso notifiche
Cronometro
Monitor per frequenza cardiaca
Schermo OLED da 0,66"
Laccetto in gomma
Disponibile in tante varianti colore
”

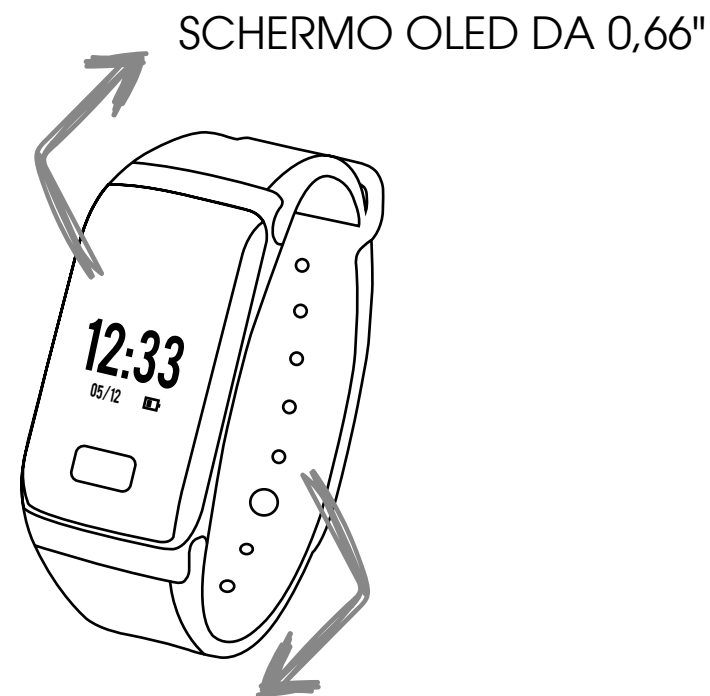

LACCETTO IN GOMMA



38036 **liatorp**

Smart watch bluetooth multilingua. Schermo LCD 0,42". Ricaricabile tramite USB | Smart watch with bluetooth connexion, multi lingual. LCD screen 0,42". USB rechargeable | Smart watch bluetooth multilinguaje con pantalla LCD 0,42". Recargable con USB | Smartwatch bluetooth multilingue. Ecran LCD 0,42". Rechargeable par USB
Plastica | Plastic | Plástico | Plastique

25,5 x 1,5 x 0,9 cm T8 | L10 100

38037 **lillabo**

Smart watch bluetooth multilingua. Schermo OLED 0,42". Ricaricabile tramite USB | Smart watch with bluetooth connexion, multi lingual. OLED screen 0,42". USB rechargeable | Smart watch bluetooth multilinguaje con pantalla OLED 0,42". Recargable con USB | Smartwatch bluetooth multilingue. Ecran LCD 0,42". Rechargeable par USB
Plastica | Plastic | Plástico | Plastique

26 x 2,4 x 1,2 cm L10 100

32041 **cove**

Orologio multifunzione | Multifunctional watch | Reloj multifuncion | Montre
Silicon | Silicon | Silicona | Silicon

25 x 3 x 1,5 cm 50 / 100

HOM

*sweet*HOME

Accessori per la casa, taglieri in bamboo, set di coltelli, rotelle taglia pizza. Apri bottiglie, set per in vino, borse, fasce rinfresca vino, grembiuli, utensili da cucina e tazze.

148 - 207

casa - home - maison

70031 *bosques*

Tagliere per aperitivo con supporto per calice di vino |
Chopping board for aperitif with support for a glass of wine |
Tajadera para aperitivo con soporte para una copa de vino |
Planche à découper pour apéritif avec support pour un verre de vin

Bambù | Bamboo | Bambú | Bambou

25 x 15 x 0,8 cm 🍷 L6 7 x 2 cm 📦 50





70029 *cathedral*

Vassoio | Serving dish | Bandeja | Plateau
Bambù | Bamboo | Bambú | Bambou

18 x 0,9 x 6 cm L8 2 x 2 cm 50 / 300



70051 *pokrov*

Set Gourmet. 2 Pezzi | Gourmet Set. 2 Pieces. | Set Gourmet. 2 Piezas.
| Collection sel et poivrier
Legno | Wood | Madera | Bois

17,5 x 10 x 1,5 cm 4 x 2 cm 36

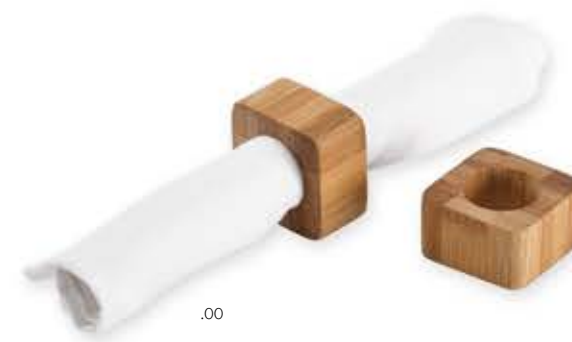

70019 *mesquite*

Set di 2 portatovaglioli | Set of two napkin rings | Set de 2 aros para servilletas
| Set de 2 ronds de serviette
Bambù | Bamboo | Bambú | Bambou

4,5 x 4,5 x 2,5 L3 3 x 1,5 cm 250/500



74070 *släkt*

Scatola per bustine da tè | Box for tea bags | Caja para bolsas de té e infusiones | Boite à thé (The bags excl.)
Bambù | Bamboo | Bambú | Bambou

16 x 7,8 x 8,7 cm 5 x 5 cm

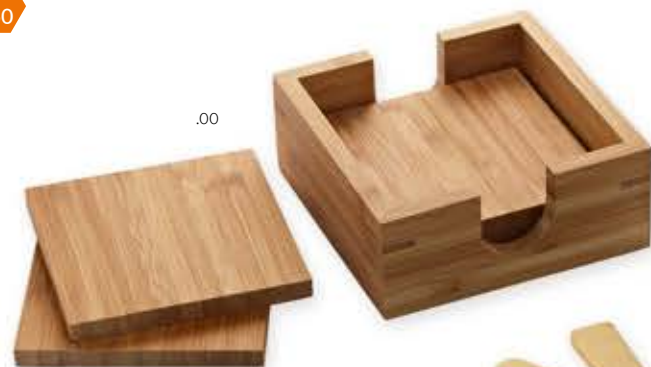

74049 *martin*

Set 4 sottobicchieri | Coasters set, 4pcs | Set 4 posavasos
| Set 4 sous-verres
Bambù | Bamboo | Bambú | Bambou

11 x 11 x 4 cm T8 | L9 3 x 3 cm 12/36



70020 *lene*

Set per insalatiera | Salad set | Set ensaladera |
Set pour salades
Bambù | Bamboo | Bambú | Bambou

30 x 6 cm T5 | L21 2 x 2 cm 12/48



70011 *elin*

nsalatiera | Salad bowl | Ensaladera | Saladier
Bambù | Bamboo | Bambú | Bambou

21,4 x 21,4 x 6,7 cm T8 | L19 4 x 2 cm 1/12



70401 *claus*

Tagliere per formaggi con posate e ciotola | Cheese chopping
board with cutlery and bowl | Tabla para quesos con cubiertos y
bol | Planche à découper pour fromage avec couverts et bol
Bambù, acciaio inox, ceramica | Bamboo, stainless steel, ceramic
| Bambú, acero inox, cerámica | Bambou, acier inoxydable,
céramique

30 x 20 x 1,2 cm



CHOPPING board

.00

Home
152



.00

.00

70016 *liam*

Tagliere | Chopping board | Tabla de cocina | Planche à découper.
Bambù | Bamboo | Bambú | Bambou

30 x 15 x 0,8 cm 🌿 L8 7 x 2 cm 📦 20/80

70006 *capelvenere*

Tagliere | Board | Tabla de cocina | Planche à découper
Bambù | Bamboo | Bambú | Bambou

30 x 20 x 0,9 cm 🌿 L8 5 x 5 cm 📦 1/20

70030 *kabele*

Coppia di chopsticks | Chopsticks | Set palillos | Set baguettes
Bambù | Bamboo | Bambú | Bambou

22,5 cm 🌿 T6 2 x 1 cm 📦 50 / 500



.01



.02



70000 *girasole*

Tagliere con set coltelli per formaggio | Cheese cutting board | Set tabla queso | Set pour fromage
Bambou, metallo | bamboo, metal | Bambú, metal | Bambou, métal

30 x 14 x 3,1 cm 🌿 L9 4 x 2 cm 📦 1/20

.00

Home
153



.00

.00

70024 *jaspar*

Tagliere per formaggi | Cheese chopping board | Tabla de cortar para el queso | Planche à découper pour fromages
Bambù | Bamboo | Bambú | Bambou

30 x 26 x 1,8 cm 🌿 L9 4 x 2 cm 📦 1/20

70044 *carpino*

Tagliere per formaggi | Cheese chopping board | Tabla de cortar para el queso | Planche à découper pour fromages
Bambù | Bamboo | Bambú | Bambou

33 x 19,5 x 1,5 cm 🌿 L9 4 x 2 cm 📦 1/20



.02 .08 .18

82053 *cynara*

Cucchiaio da cucina. | Cooking spoon | Cucharas de cocina | Cuillère avec bout en silicone (Unit price)
Bambù, silicone | Silicone and bamboo | Bambú, silicona | Bambou, silicone

21 cm T8/L7 4 x 1 cm 40/280



.02 .08 .18

82054 *gizzeraia*

Spatola da cucina. | Spreader | Untador de cocina | Palette de cuisine avec bout en silicone (Unit price)
Bambù, silicone | Silicone and bamboo | Bambú, silicona | Bambou, silicone

21 cm T8/L7 4 x 1 cm 40/280



.00

70054 *viktigt*

Set di 2 coltelli 20cm | Knives set 20cms | Set de 2 cuchillos de 20cms | Set 2 couteaux 20cm
Legno, acciaio inox | Wood, stainless steel | Madera, acero inoxidable | Bois, acier inox

26 x 12.5 x 2.8 cm S86 6 x 6 cm 25



.01

70050 *zeke*

Set Formaggi. 4 Pezzi | Cheese Set. 4 Pieces | Set Quesos. 4 Piezas | Set pour fromage (4 pièces)
Legno, metallo | Wooden, metal | Madera, metal | Bois, métal

19 x 16 x 2,3 cm S86 4 x 4 cm 5/40



.00

70402 *kalkgrund*

Cucchiaio | Spoon | Cuchara | Cuillère
Bambù | Bamboo | Bambú | Bambou

30 x 6 x 0,8 cm T8 4 x 1,5 cm 50 / 200



.00

70053 *fullfölja*

Set di 5 coltelli per formaggi | Cheese set with 5 knives | Kit con 5 cuchillos para quesos | Set 5 couteaux pour fromages
Legno, acciaio inox, PP | Wood, stainless steel, PP | Madera, acero inox, PP | Bois, acier inox, PP

13 x 15 x 5,6 cm L9



fullfölja



.32

76034 *diveyevo*

Set vino | Wine set | Wine set | Accessoires vin
Acciaio | Steel | Acero | Acier

22,3 x 8 x 3 cm 🍷 S86 4 x 4 cm 📦 50



.32

76033 *namur*

Set da vino con apribottiglia e tappo | Wine set with bottle-opener and cork | Set para el vino con abrebotellas y tapón | Set à vin avec ouvre-bouteille et bouchon
Acciaio | Steel | Acero | Acier

10,3 x 13,3 x 2,8 🍷 S86 4x4cm 📦 20/80



.08



.32

76789 *hållö*

Set da vino con 3 accessori | Wine set with 3 accessories | Set de vinos con 3 accesorios | Set vin avec 3 accessoires
Plastica, acciaio | Plastic, steel | Plástico, acero | Plastique, acier

24 x Ø 6,4 cm 🍷 T8



.32

76788 *grundvattnet*

Set da vino con 5 accessori | Wine set with 5 accessories | Set de vinos con 5 accesorios | Set vin avec 5 accessoires
Plastica, acciaio | Plastic, steel | Plástico, acero | Plastique, acier

32,5 x Ø 7,3 cm 🍷 T8



.00

82050 *nymåne*

Cavatappi in astuccio | Corkscrew in a box | Sacacorchos con estuche | Tire bouchon avec étui
Bambù, acciaio inox | Bamboo, stainless steel | Bambú, acero inox | Bambou, acier inoxydable

17 x 8 x 3 cm 🍷 S18 | L19 2 x 3 cm 📦 25 / 100



.00

82051 *dodoma*

Apri bottiglie | Bottle opener | Abrebotellas | Ouvre-bouteille avec poignée en bois
Bamboo | bamboo | Bambú | Bambou

14,4 x 2,5 x 1,9 cm 🍷 T8 / L7 6 x 1 cm 📦



.00



.00

Home
158

Home
159



.00

76020 *naig*

Set Vino, 4 accessori, in scatola regalo | Wine set in deluxe wooden gift box, 4 pcs | Elegante set de vino presentado en estuche de madera con argolla antigoteo, termómetro, tapón y sacacorchos | Collection vin, 4 accessoires en paquet cadeau
Legno | Wooden | Madera | Bois

15 x 16 x 5,5 cm 🍷 S18 | L19 4 x 4 cm 📦 1 / 40



.11

75095 *reid*

Set da vino, 4 pz. in scatola di legno | Wine set in wooden box, 4 pcs | Set vino, 4 pz | Collection pour vin, accessoires en paquet cadeau
Legno | Wooden | Madera | Bois

4 x Ø 16 cm 🍷 S18 | L19 4 x 2 cm 📦 1 / 20

76050 *vimle*

Set vino con scatola con tagliere e cavatappi | Box for a bottle of wine with chopping board and corkscrew | Set caja para botella de vino con tabla y sacacorchos | Set vin avec boîte avec planche à découper et ouvre-bouteille
Bambù, acciaio inox | Bamboo, stainless steel | Bambú, acero inoxidable | Bambou, acier inox

36 x 11 x 12 cm 🍷 S15 6 x 6 cm 📦 8

76006 *tuala*

Set Vino, 4 accessori, in scatola regalo (vino non incluso) | Wine set in deluxe wooden gift box, 4 pcs. Wine not included | Estuche con acabado en polièpila para una botella y 4 accesorios para el vino. Vino no incluido | Collection vin, 4 accessoires en paquet cadeau (vin non inclus)
Legno | Wooden | Madera | Bois

36 x 11 x 12 cm 🍷 S15 | L9 4 x 4 cm 📦 1 / 12



.00

82026 *adil*

Apribottiglie con coltellino | Multifunction bottle opener with knife | Abrebotella con cuchillo | Ouvre-bouteille avec petit couteau
Metallo, legno | Metal, wood | Metal, madera | Métal, bois

11 x 2,5 x 0,8 cm T8/L7 2,5 x 0,8 cm 12/216



.04

.07 .08 .05 .01

82003 *cem*

Coltellino e apribottiglie traslucente 3 funzioni | Bottle opener with knife. 3 functions | Cuchillo y abrebotellas 3 funciones | Petit couteau et ouvre-bouteille translucide 3 fonctions
Alluminio, inox, plastica | Aluminium, inox, plastic | Aluminio, inox, plástico | Aluminium, inox, plastique

11 x 2,5 x 1,3 cm T7 | UV2 2,5 x 0,8 cm 12/120



.03

.06

82044 *gambara*

Apribottiglie con caturaccioli e aprilatine | Bottle opener with corkscrew and can opener | Abrebotellas con sacacorchos | Tire-bouchon avec ouvre-bouteille

Plastica, metallo | Plastic, metal | Plástico, metal | Plastique, métal

14,5 x 1,6 x 1,9 cm T7 2 x 1 cm 50/500



.01

82012 *jesse*

Caturaccioli | Bottle-opener, cork-stopper | Sacacorchos | Tire-bouchon
Plastica | Plastic | Plástico | Plastique

7 cm T7 3 x 1 cm 20/120



.01

.02

82013 *gambettola*

Cavatappi, 4 funzioni | Four function waiter's knife | Navaja camarero, 4 funciones | Tire-bouchon, 4 fonctions

Plastica, metallo | Plastic, metal | Plástico, metal | Plastique, métal

13 x 2,5 x 1 cm T7 | UV3 3 x 1 cm 12/288



.01

82006 *sam*

Cavatappi | Bottle opener | Sacacorchos | Tire-bouchon
Plastica | Plastic | Plástico | Plastique

11 x 2,5 cm T7 2,5 x 1 cm 20/200



82008 *tait*

Cavatappi professionale, 3 funzioni | Steel three function waiter's knife | Navaja camarero 3 funciones | Tire-bouchon professionnel, 3 fonctions
Acciaio | Steel | Acero | Acier

11 x 2,5 x 1 cm T8 | L7 4 x 0,4 cm 24/144



.32



.29

.17

.18

.07

82022 *owen*

Cavatappi | Bottle opener | Sacacorchos | Tire-bouchon
Plastica | Plastic | Plástico | Plastique

17 x 8 x 3 cm T7 2,5 x 0,8 cm 1/48



.21

17490 *bad*

Borsa portabottiglia | Single bottle bag | Bolsa para botella de vino | Sac porte-bouteille
EVA

12 x 11,5 x 34 cm S95 5 x 5 cm 200



.21

.05

17112 *acerola*

Borsa rinfresca bottiglia | Bottle Cooler Bag | Bolsa refresca botellas | Raffraichisseur pour bouteille
Plastica | Plastic | Plástico | Plastique

10 x 25 x 10 cm S7 4 x 4 cm 80

Home
162



.02

76030 *williston*

Porta champagne | Ice bucket | Cubo para botellas | Porte bouteilles
Plastica | Plastic | Plastico | Plastique

19 x 24,5 x 20 cm T8 5 x 3 cm 1/6



.32

76028 *middletown*

Cover rinfresca vino per bottiglie | Fold-up wine cooler | Enfriador de vino | Cover rafraissante
PVC | PVC | PVC | PVC

32 x 15 cm S95 5 x 2 cm 30/60

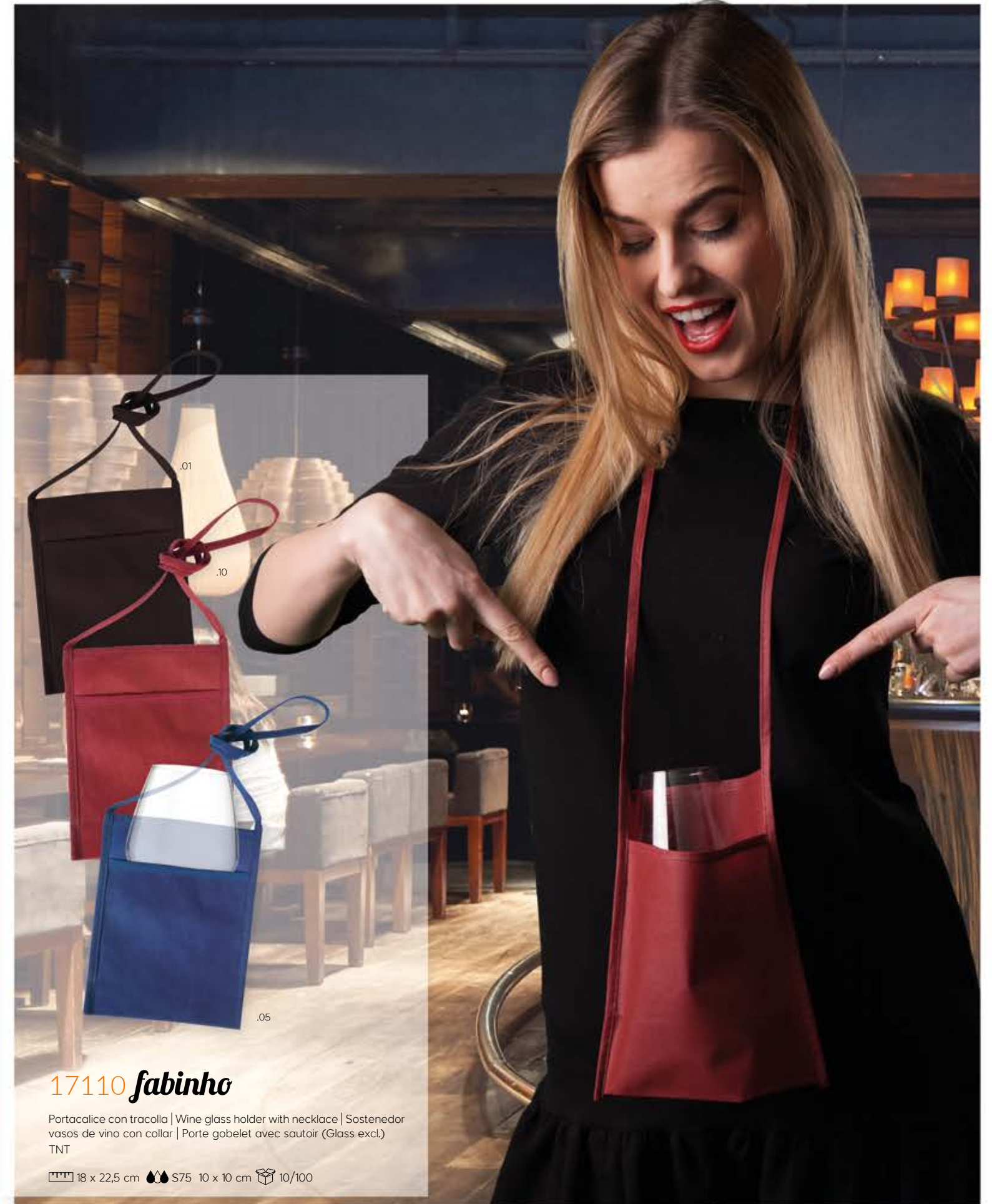

.01

.10

.05

17110 *fabinho*

Portacalice con tracolla | Wine glass holder with necklace | Sostenedor vasos de vino con collar | Porte gobelet avec sautoir (Glass excl.)
TNT

18 x 22,5 cm S75 10 x 10 cm 10/100

BOTTLE SINGLE Bag



.01



.08



.05



.13



.13

Home
164

Home
165



.10



.07



.10

.01

17156 *vibeke*

Borsa per 1 bottiglia (non inclusa) | Single bottle bag (bottle not included) | Bolsa en para 1 botella (no incluida) | Sac porte bouteille (bouteille non incluse). Non Woven

10 x 33 x 10 cm ♻️ S98 5x10 cm 📦 50/400

17017 *rohan*

Borsa portabottiglia vino (vino non incluso) | Single bottle bag(wine excluded) | Bolsa de tejido sin tejer para 1 botella de vino (vino no incluido) | Sac porte-bouteille (vin non inclus) Non Woven

13 x 33 x 10 cm ♻️ S98 5 x 15 cm 📦 100/400

17170 *castagna*

Borsa porta bottiglia | Gift Bag for wine bottle | Bolsa de Non-woven para llevar botellas | Sac porte-bouteille Non Woven

13 x 40 x 10 cm ♻️ S98 4 x 10 cm 📦 600

17052 *berk*

Borsa per 2 Bottiglie (non incluse) | Double bottle bag (wine excluded) | Bolsa en para 2 botellas (no incluidas) | Sac porte-bouteilles pour 2 bouteilles (vin non inclus) Jute | Jute | Yute | Jute

20 x 34,5 x 10 cm ♻️ S98 8 x 5 cm 📦 25/150

17049 *sezar*

Borsa per 1 Bottiglia (non inclusa) | Single bottle bag(wine excluded) | Bolsa en para 1 botella (no incluida) | Sac porte-bouteille (vin non inclus) Jute | Jute | Yute | Jute

10,5 x 35 x 10 cm ♻️ S98 5 x 5 cm 📦 25/250

46081 josefin

Apribottiglia con funzione di portachiavi | Bottle opener with keyring | Abrebotellas con llavero | Porteclé avec ouvre-bouteille
Alluminio | Aluminium | Aluminio | Aluminium

5,5 x 0,9 x 1,4 cm L1 1,5 x 0,5 cm 1/1000



josefin



82038 zhelnino

Apribottiglia | Bottle opener | Abrebotellas | Ouvre-bouteille
Plastica | Plastic | Plástico | Plastique

14,8 x 1 x 4,7 cm T6 | UV2 3 x 1 cm

100/400



82004 joel

Apribottiglia con funzione di tappabottiglia | Bottle opener | Abrebotellas y tapón con forma de puño | Ouvre-bouteille avec fonction de bouchon
Plastica | Plastic | Plástico | Plastique

9,2 x 4 x 1 cm T6 | UV2 3,5 x 2 cm

50/600



82046 germasino

Apribottiglia in alluminio | Aluminium | Aluminium | Aluminium

3,8 x 0,3 x 8,5 cm L2 3 x 1 cm 50/300



82055 dynan

Apribottiglie con portachiavi | Bottle opener with keyring | Abridor con llavero | Ouvre-bouteille avec porteclé
Alluminio | Aluminium | Aluminio | Aluminium

7,9 x 1,5 x 0,9 cm L1 3 x 0,8 cm 50 | 500



76777 vin

Tappo | Bottle stopper | Tapón botella vino | Vin bouchon

3 x Ø 3 cm T7 Ø 1,5 cm 100/500



46005 raimu

Portachiavi con apribottiglia | Fish shaped keyring with bottle opener | Llavero con abrebotellas | Porteclés avec ouvre-bouteille
Metallo | Metal | Métal | Metal

9 x 2,5 x 0,3 cm L5 | T6 3 x 0,8 cm 50 | 1000



82045 drip

Salva goccia | Drop stopper ring | Antigoteo | Anti-goutte
Metallo | Metal | Metal | Métal

Ø 4 x 2 cm L2 2 x 0,8 cm 500



76000 kane

Tappo per bottiglia di Champagne | Champagne bottle stopper | Tapón para cerrar la botella de Champán | Bouchon pour bouteille de champagne
Metallo | Metal | Metal | Métal

5,5 x Ø 4 cm L7 1,5 x 1 cm 50/200

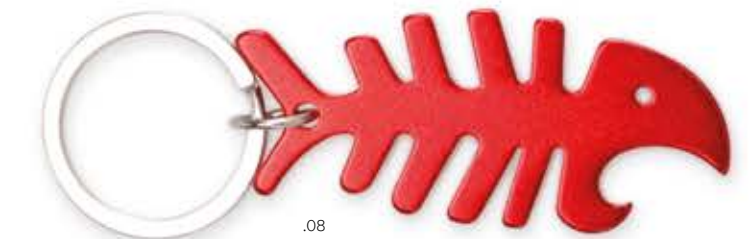



82122 *nashville*

Apribottiglia con magnete | Bottle opener with magnet | Abrebotellas con imán
 | Ouvre-bouteille avec aimant
 Plastica | Plastic | Plástico | Plastique

5 x 10,5 x 0,5 📦 T6 | UV2 5 x 2 cm 📦 100/600

46067 *robban*

Apribottiglia con funzione di portachiavi | Bottle opener with keyring |
 Abrebotellas con llavero | Portecleuvre-bouteille
 Alluminio | Aluminium | Aluminio | Aluminium

1,3 x 6,7 x 1,5 cm 📦 L1 2 x 0,5 cm 📦 200/1000



17037 *oder*

Cappello da chef | Chef hat | Gorro de Chef | Toque de chef
 TC

S37 | TR16 5 x 5 cm 📦 50/250



82712 *guzmanes*

Apribottiglie, sottobicchiere | Coaster and bottle opener | Abrebotellas,
 posavasos | Ouvre-bouteilles, dessous
 Plastica, EVA | Plastic, EVA | Plástico, EVA | Plastique, EVA

8,2 x 8,2 x 0,4 cm 📦 T6 | UV9 8 x 8 cm 📦 100 / 500



17185 *kabwe*

Grembiule | Apron | Delantal | Tablier
 Poliestere | Polyester | Poliéster | Polyester

90 x 90 cm 📦 S98 10 x 10 cm 📦 10 / 60



17186 *kalambue*

Grembiule | Apron | Delantal | Tablier
 Poliestere | Polyester | Poliéster | Polyester

54 x 30 cm 📦 S98 10 x 10 cm 📦 125 / 200

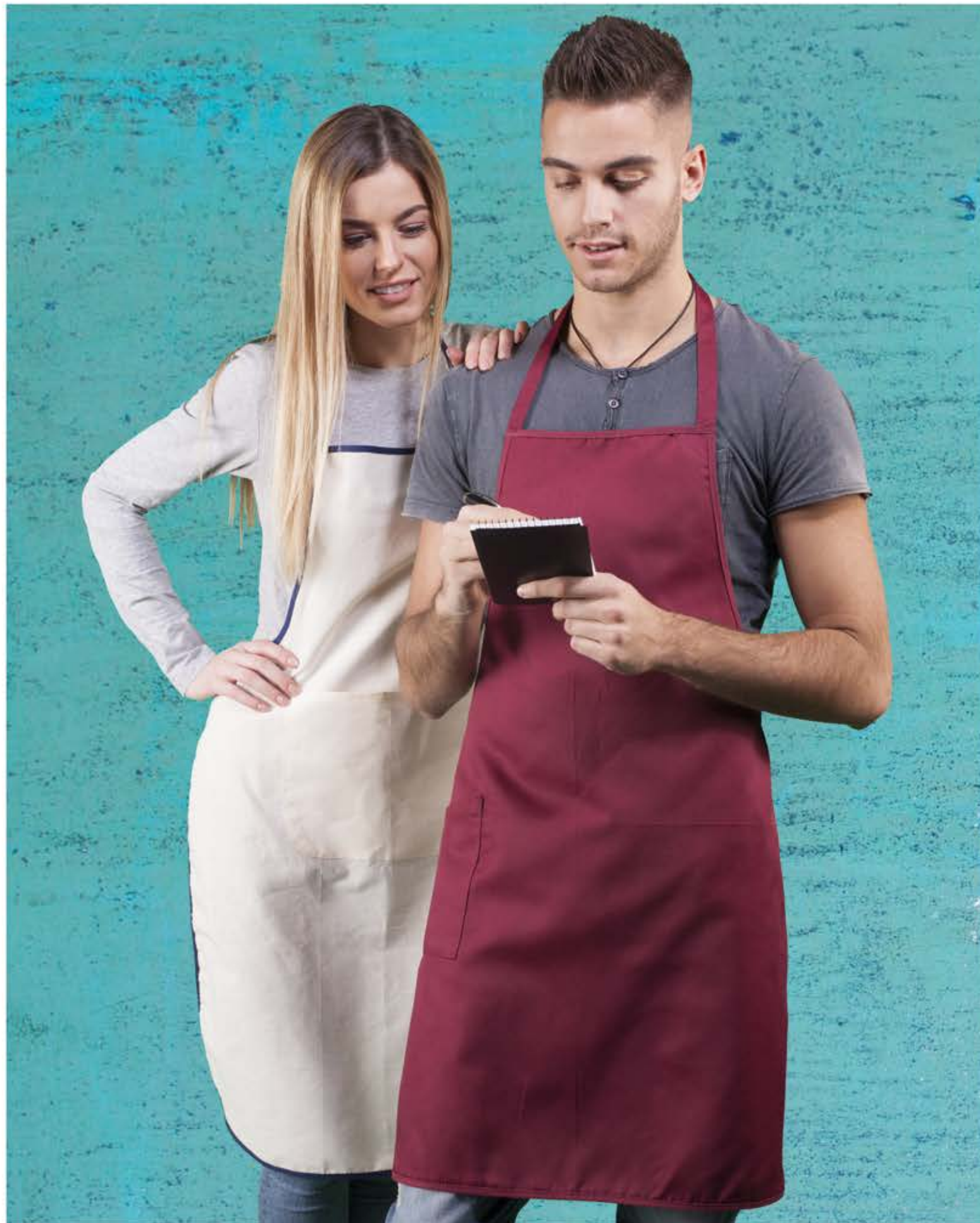

KITCHEN apron



.10



.19



.19

.23

.04

.08

.01

.02



.08

.13

.07

.05

17008 *axel*

Grembiule | Apron | Delantal | Tablier de cuisine
65% Poliestere - 35% Cotone | 65 % Polyester - 35 % Cotton | 65% Poliéster - 35 %
Algodón | 65% Polyester - 35%Coton (200 gr/m²)

75x80 cm ♻️ S98 | TR2 (colored) | TR28 (White color) 10 x 15 cm 📦 25/100

17005 *erim*

Grembiule da cucina ecru' | Natural color apron | Delantal por cucinar en ecru
| Tablier couleur naturelle avec bord coloré
Cotone | Cotton | Algodón | Coton (100 gr/m²)

79 x 59 cm ♻️ S97 | TR28 10 x 15 cm 📦 25/200



17481 *pittsburgh*

Grembiule da cucina | Kitchen Apron | Delantal de cocina | Tablier de cuisine TC

90 x 65 cm S98 | TR2 10 x 10 cm 10/100



17476 *augusta*

Grembiule da cucina | Kitchen Apron | Delantal de cocina | Tablier de cuisine
Cotone Jeans | Cotton | Algodón | Coton

65 x 90 cm S98 10 x 15 cm 5/100



17071 *grill*

KITCHEN
apron



grill



17071 *grill*

Grembiule con tasca | Apron with pocket | Delantal con bolsillo
Tablier avec poche
Cotone | Cotton | Algodón | Coton (95 gr/m²)
60 x 90 cm S97 10 x 15 cm 10/50

17000 rita

Grembiule con tasca | Apron with pocket | Delantal con bolsillo | Tablier avec poche
 Cotone | Cotton | Algodón | Coton (145 gr/m²)

65 x 90 cm S98 | TR2 (colored) | TR28 (White color) 10 x 15 cm 10/100



rita



.19



.01

.02



.07

.08



.05

.06

.13



.04



.05

.02

.08



.03

.01



.13



.01

17475 auce

Grembiule da cucina | Kitchen Apron | Delantal de cocina | Tablier de cuisine
 Cotone | Cotton | Algodón | Coton (180 gr/m²)

65 x 90 cm S98 | TR2 (colored) | TR28 (white color) 10 x 15 cm
 20/100

17126 stoccarda

Grembiule da cucina | Apron | Delantal de cocina | Tablier de cuisine
 Cotone | Cotton | Algodón | Coton (105 gr/m²)

47 x 69 cm S98 | TR2 10 x 10 cm 20/200



.04



.05

.02

.17

.01

.06

.19

.08



.08



.05



.05

.01

.08

17081 uno

Grembiule da cucina | Kitchen apron | Delantal cocina | Tablier de cuisine
 Non-Woven

50 x 73 cm S98 | TR2 15 x 10 cm 10/200

17004 xen

Grembiule da cucina bicolore | Cotton apron | Delantal con bolsillo frontal |
 Tablier de cuisine bicolore
 Cotone | Cotton | Algodón | Coton

79 x 59 cm S98 | TR2 10 x 10 cm 50/200

17086 sione

Grembiule | Apron | Delantal | Tablier de cuisine
 Poliestere, Cotone | Polyester, Cotton | Poliéster, Algodón | Polyester, Coton

55 x 29 cm S98 10 x 10 cm 50/200



.08

.02

.23

17157 *giacarta*

Presina da cucina. | Potholder | Manopla | Manique
Cotone | Cotton | Algodón | Coton

16,5 x 16,5 cm S8 5 x 5 cm 50/500



.07

.05

17001 *jaxen*

Presina bicolore | Cotton oven pot holder | Agarrador de cocina |
Manique bicolore
Cotone | Cotton | Algodón | Coton

17 x 17 cm S8 | TR1 7 x 3 cm 1/400



.07

17002 *jaxum*

Guanto bicolore da cucina | Cotton oven mitten, single | Guante de
cocina | Gant bicolore de cuisine
Cotone | Cotton | Algodón | Coton

19 x 28 cm S8 | TR1 7 x 3 cm 25/150



.11



.08

.05

.02

17161 *fahad*

Guanto da cucina | Oven mitt | Guante de cocina | Gant de cuisine
Cotone, Poliestere | Cotton, Polyester | Algodón, Poliéster | Coton,
Polyester

16 x 26 cm S8 5 x 5 cm 10/200

17003 *solena*

Guanto da cucina | Cotton oven mitten | Guante de cocina |
Gant de cuisine avec bord coloré
Cotone | Cotton | Algodón | Coton

19 x 28 cm S8 10 x 10 cm 50/250



.07

.19

.05

.08



solena



.13

17016 *elvan*

Borsa portapane per 2 baguette | Cotton bread bag with drawstring
| Bolsa de algodón para pan | Sac porte pain pour 2 baguettes
Cotone | Cotton | Algodón | Coton

📏 20 x 58,5 cm 💧 S75 | TR21 20 x 10 cm 📦 50 | 200



.08

.01

.05



17194 *grotte*

Guanto da cucina | Oven mitten | Guante de cocina | Gant de cuisine
avec bord coloré
Poliestere | Polyester | Poliéster | Polyester

📏 19 x 28 cm 💧 10 x 10 cm 📦 50 / 200



.23



72010 *tina*

Maniglia per trasporto borsa della spesa | Bag holder | Asa para llevar bolsas
| Manche pour transporter les courses
Plastica | Plastic | Plástico | Plastique

📏 14 x 2 x 4 cm 💧 T6 3 x 1 cm 📦 100/400



oliver

79013 *oliver*

Tovaglietta americana | Table placemat | Mantel individual |
Serviette de table
TNT No wovens

📏 40 x 30 cm 💧 S76 15 x 25 cm 📦 100/500



.08



.05



.01

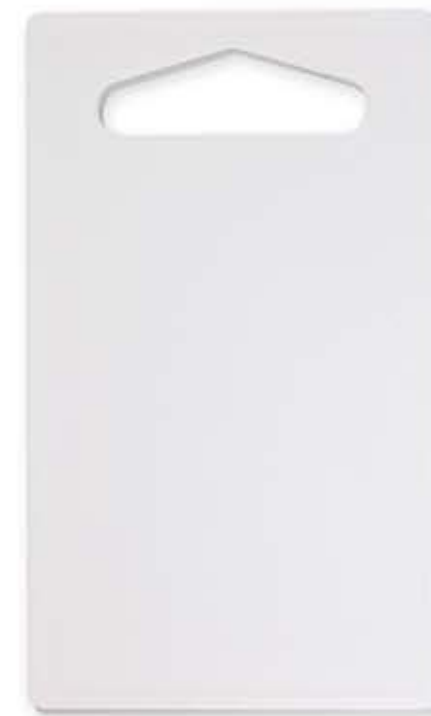

.02



.08



.23

70014 *kenneth*

Tagliere da tavola | Chopping board | Tabla de cortar | Hachoir
Plastica | Plastic | Plástico | Plastique

📏 14 x 23,6 x 0,4 cm 💧 DP2 | L8 5 x 5 cm 📦 25/150



.02

70017 *nama*

Set cucina con tagliere, pelapatate e coltello in ceramica | Chopping board
with knife and peeler | Juego de cocina | Set cuisine
Plastica, ceramica | Plastic, ceramic | Plástico,cerámica | Plastique, céramique

📏 24,5 x 3,4 x 14,7 cm 💧 S86 5 x 5 cm 📦 20/40



75041 *etamin*

Contenitore per sandwich | Lunch box for sandwich | Tartera para Sandwich
| Lunch box pour sandwich
Plastica | Plastic | Plástico | Plastique

13 x 5 x 13,5 cm S3 4 x 4 cm 1/40



75006 *jorn*

Contenitore per alimenti | Lunch box | Fiambrera para almuerzo |
Boîte de rangement pour déjeuner
Plastica | Plastic | Plástico | Plastique

15,5 x 6 x 22,5 cm S96 4 x 1 cm 1/40



79447 *nunki*

Padella per friggere. 24 cm | Frying Pan. Aluminium/ Ceramics, 24 cm. Suitable for all
Types of Hobs | Sartén de aluminio/cerámica de 24 cm | Poêle à frire. 24cm
Alluminio, ceramica | Aluminium, ceramic | Alluminium, ceramic | Alluminium, ceramic

4,5 x Ø 24 cm T8 | L10 4 x 1 cm 10



.08

.02

.06

.08

.02

.06

Padella per friggere. 24 cm | Frying Pan. Aluminium/ Ceramics, 24 cm. Suitable for all
Types of Hobs | Sartén de aluminio/cerámica de 24 cm | Poêle à frire. 24cm
Alluminio, ceramica | Aluminium, ceramic | Alluminium, ceramic | Alluminium, ceramic

4,5 x Ø 24 cm T8 | L10 4 x 1 cm 10



74081 *cassiopea*

Contenitore per alimenti 750 ml | Lunch Box 750 ml | Fiambrera para
almuerzo de 750 ml | Boîte de rangement pour déjeuner. 750 ml
Plastica | Plastic | Plástico | Plastique

19,5 x Ø 11,5 cm T29 5 x 2 cm 40



75009 *jurrian*

Spazzola da cucina | Cooking brush | Brocha de
cocina | Brosse de cuisine
Silicone | Silicone | Silicona | Silicone

17,5 x 3 x 1 cm T6 4 x 1 cm 50/600



75036 *alpekka*

Set coltelli, 4 pezzi | Knife set, 4 pieces | Set cuchillos, 4 piezas | Set couteaux,
4 pcs
Plastica | Plastic | Plástico | Plastique

23 cm Ø 7,3 cm T9 3 x 1 cm 30



82027 *ingvar*

Coltello | Knife | Cuchillo | Couteau
Acciaio inossidabile | Stainless steel | Acero inoxidable | Acier inoxydable

3 x 20,5 x 1,5 cm T6 3 x 1 cm 100/300



75032 *gradus*

Coltello da torta | Cake knife | Cuchillo para pastel | Couteau à gâtea
Polipropilene | Polypropylene | Polipropileno | Polypropylène

6 x 29,8 x 1,1 cm T6 3 x 1 cm 50/300



.02

.23

.08



.00



.02

.08

.05

82229 *daki*

Rotella Pizza con manico colorato | Pizza cutter with plastic handle | Cortador de pizzas con mango de plástico | Roulette à pizza
Plastica | Plastic | Plástico | Plastique

16,5 x 9,8 x 0,5 cm T6 4 x 1 cm

50/300

82052 *curcuma*

Tagliapizza | Pizza cutter | Cortador pizza | Roulette à pizza
Legno | Wood | Madera | Bois

17 x 7 cm T8/L7 6 x 1 cm

50/200

82036 *carex*

Tagliapizza con apribottiglia | Pizza cutter with bottle opener | Corta pizza con abrebotellas | Coupe-pizza avec ouvre-bouteille
Plastica | Plastic | Plástico | Plastique

13,4 x 6,3 x 0,8 cm T6 | UV2 3,5 x 1,5 cm

50/500



.01

71024 *wafero*

Coltello in ceramica. Custodia individuale | Knife ceramics. Individual case | Cuchillo de cerámica. Estuche individual | Couteau céramique. Etui individuel
Abs, ceramica | Abs, ceramics | Abs, cerámica | Abs, céramique

3,3 x 25 x 1,5 cm S27 2 x 6 cm 10/40



.02

73000 *gaglianico*

Coltello con pelaverdure | Knife and peeler set. | Cuchillo y pelador 2 en 1 | Couteau avec épilucheur
Plastica, ceramica | Plastic, ceramic | Plástico, Cerámica | Plastique, céramique

9 x 2,5 x 1,7 cm T6 3 x 1 cm 50/200



.04

.02

.24

.07

.06

.05

74131 *kobuk*

Bicchieri con fessura sul coperchio, 440 ml | Mug with drinking opening, 440 ml | Vaso con apertura para beber en tapa, 440 ml | Verre avec fente sur couvercle, 440 ml
PP

13 x Ø 9,1 cm T8 6 x 2 cm



.07

.04

.23

.06

.08

74155 *trou*

Bicchieri con coperchio apribile | Glass with openable top | Vaso con tapa que se puede abrir | Verre avec verre ouvrant
Plastica | Plastic | Plástico | Plastique

16,5 x Ø 8,5 cm



.01

.05

.04

.08

74076 *mizar*

Bicchieri 350 ml | Glass 350 ml | Vaso 350 ml | Verre 350ml
Plastica, Silicone | Plastic, Silicone | Plástico, Silicona | Plastique, Silicone

11,5 x Ø 9,7 cm T8 3 x 2 cm 48



.29

.08

.23

74047 *marit*

Bicchieri con coperchio e presa in silicone | Coffee mug with silicon lid and silicon band | Vaso con tapa y mango de silicona | Verre en céramique avec couvercle et tour de tasse en silicone
Ceramica | Ceramic | Cerámica | Céramique

Ø 10 x 17 cm T28 3x3 cm 1/36





MUG CERAMIC SUBLIMATIC



74028 erman

Tazza magica nera che cambia colore con la temperatura, capacità 300 ml | "Magic" Black mug (300 ml) | Taza negra "Magic" (300 ml) | Tasse magique noire qui change de couleur en fonction de la température (300ml)

Ceramica | Ceramic | Cerámica | Céramique

9,5 x 8 cm SP2 8 x 20 cm 1/48



74054 prali

Tazza per sublimazione, confezione individuale | Mug for sublimation printing in individual box | Taza sublimación, presentación caja individual | Tasse pour personnalisation en sublimation avec boîte individuelle (Capacity 300ml)

Ceramica | Ceramics | Cerámica | Céramique

9,5 x 8,2 cm SP3 8 x 20 cm 1/36



74190 penza

Tazza con cucchiaino per sublimazione, 300 ml | Mug with spoon for sublimation printing, 300 ml | Taza sublimación con cuchara, 300 ml | Tasse avec cuillère pour personnalisation, 300 ml

Ceramica | Ceramic | Ceramic | Céramique

9,5 x 8 cm SP3 8 x 20 cm 1/40



74005 madina

Tazza Mug, con trattamento per sublimazione, capacità 300 ml con box | Mug for sublimation printing in individual box, 300 ml | Taza para sublimation 300 ml | Tasse pour personnalisation en sublimation avec boîte individuelle (300ml)

Ceramica | Ceramic | Cerámica | Céramique

9,5 x 8 cm SP2 8 x 20 cm 1/36



74151 gonnese

Tazza sublimatica | Squared mug for sublimation | Taza sublimación cuadrada | Mug pour sublimation

Ceramica | Ceramic | Cerámica | Céramique

8 x 8 x 8 cm SP3 7 x 18 cm 1/36



74154 *gaggi*

Tazza | Metallic Mug | Taza metálica | Tasse métallique 350ml
Metallo | Metal | Metal | Métal

☞ 8 x Ø 8 cm ☞ L13 | T8 4 x 2 cm ☞ 6/120

chysis



74152 *chysis*

Tazza effetto gommato | Mug with rubber finish | Taza con acabado en caucho | Tasse effet gommé
Cerámica | Ceramic | Cerámica | Céramique

☞ 9,5 x Ø 9,5 cm ☞ T28 3 x 3 cm ☞ 1/24



74019 *elma*

Tazza 250 ml. | Mug 250 ml | Taza 250 ml. | Tasse 250 ml
Ceramica | Ceramic | Cerámica | Céramique

☞ 10 x Ø 9 cm ☞ C3 (12 x 7 cm) | C4 (18 x 8 cm) | T28 (4x4 cm) 6 x 3 cm ☞ 1/36



74127 *frac*

Tazza da tè con coperchio, 360 ml. | Tea cup with tap, 360 ml | Taza de té con tapa, 360 ml | Tasse à thé avec couvercle, 360 ml
Ceramica | Ceramic | Cerámica | Céramique

☞ 12 x Ø 9,4 cm ☞ T28 (4x4 cm) 6 x 3 cm ☞ 36





.19



74157 *kwania*

Tazza, 350ml. Permette l'incisione nel colore dell'interno del prodotto | Cup, 350ml. Allows engraving in the internal color of the product's | Taza, 350 ml. Permite grabar en el color del interior del producto | Coupe, 350ml. Permet de graver dans la couleur de l'intérieur du produit
Ceramica | Ceramic | Cerámica | Céramique

☞ Ø 8,2 x 9,6 cm ☞ 8 x 3 cm ☞ 1 / 36



74027 *celil*

Tazza Mug, colorata con interno bianco, 300 ml | Coloured mug with white inside part.300ml | Taza en color y blanco interior 300 ml | Tasse colorée avec partie intérieure en blanc. Capacité 300 ml
Ceramica | Ceramic | Cerámica | Céramique

☞ Ø 8 x 9,5 cm ☞ T28 (5x5 cm)

C1 (21x8 cm) | C3 (15x7 cm) 8 x 21 cm ☞ 1 / 36

COLOURED *Mug*



.08



74026 *soa*

Tazza 300 ml | Mug 300ml | Taza 300 ml | Tasse 300ml
Ceramica | Ceramic | Cerámica | Céramique

☞ Ø 9,5 x 10 cm ☞ C1 (13 x 7 cm) | C3 (12 x 7 cm) | T28 (4x4 cm)

13 x 7 cm ☞ 1 / 36



74056 *bei*

Tazza con confezione regalo 300 ml | Mug with gift box 300 ml | Taza con caja de regalo 300 ml | Tasse avec boîte-cadeau 300 ml
Ceramica | Ceramic | Cerámica | Céramique

☞ Ø 8 x 9,5 cm ☞ T28 (5x5 cm) | C3 (15x7 cm) 8 x 20 cm ☞ 1 / 48

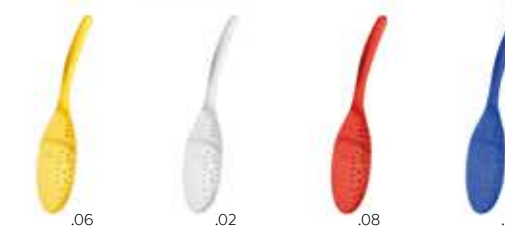

74085 *epsilon*

Infusore | Infusor | Infusor | Diffuseur
Plastica | Plastic | Plástico | Plastique

☞ 15 x Ø 3,1 cm ☞ T7 4 x 1 cm ☞ 1000



74006 arama

Tazza con cucchiaino 300 ml | Mug with spoon 300 ml | Taza con cuchara 300 ml | Tasse avec cuillère 300 ml
Ceramica | Ceramic | Cerámica | Céramique

∅ 8 x 10 cm T28 4 x 4 cm 1/36



FUNNY mug



74145 gangi

Tazza con porta biscotti | Mug with biscuit holder | Taza con porta galleta | Tasse avec porte biscuit
Ceramica | Ceramic | Cerámica | Céramique

10 x 8 x 7,5cm T28 4 x 4 cm 1/36



74444 stiu

Tazza per stampa serigrafica 350 ml | Mug for silk screen printing 350 ml
| Taza por serigrafía 350 ml | Tasse pour personnalisation en sérigraphie 350 ml

Ceramica | Ceramic | Cerámica | Céramique

∅ 8 x 9,5 cm T28 5 x 5 cm | C3 7 x 15 cm | C4 8 x 20 cm

1/36



74150 coronilla

Tazza design | Mug | Taza | Mug desing
Ceramica | Ceramic | Cerámica | Céramique

∅ 8,5 x 12 cm T28 4 x 4 cm 1/24





82711 *väddö*

Sottobicchiere SUBLY | Coaster | Posavasos | Sous verre
Mdf | Mdf | Mdf | Mdf

9,5 x 9,5 cm 500



.02

74072 *jaddor*

Scatola in cartone | Mug carton box | Caja de carton | Boité en carton
Cartone | Carton | Cartón | Carton

11,5 x 10,2 x 8,5 cm S27 5 x 5 cm 50/300



.01

.02

74053 *dago*

Set da caffè, 6 tazzine con piattino (80ml) | Coffee set, 6 pcs (80ml) | Set
de cafe, 6 piezas (80ml) | Set à café avec 6 tasses et sous tasses (80ml)
Ceramica | Ceramic | Cerámica | Céramique

28,5 x 18 x 8 cm S86 5 x 5 cm 1/6

74007 *line*

Tazzina da caffè con piattino | Coffee cup ans plate | Taza cafe y plato |
Tasse café
Ceramica | Ceramic | Cerámica | Céramique

6,3 x Ø 5,8 cm T18 2 x 1 cm 1/36

75052 *önskedröm*

Frullatore a batterie 2xAA non incluse | Mixer with batteries 2xAA not
included | Batidora a pilas 2xAA no incluidas | Mixeur à batterie (2 piles
AAA non incluses)

ABS, acciaio inox | ABS, stainless steel | ABS, acero inoxidable | ABS, acier
inoxydable

12,5 x 7,5 x 23,5 cm 2,5 cm 50



.02

49178 *yelets*

Lavagna | Blackboard | Pizarra | Tableau
Legno | Wooden | Madera | Bois

15 x 10 S96 3 x 3cm 100



.02



.08



32029 *shorty*

Timer. Pile incluse | Timer. Button Batteries Included | Temporizador cocina. Pilas incluidas | Minuteur. Piles incluses
Plastica | Plastic | Plástico | Plastique

6 x 6 x 1,6 cm T7 UV3 4 x 1 cm 300



.32



.00



.32

61021 *abakhane*

Sal e pepe manuale | Manual pepper holder for 2 types of spices | Pimentero manual para 2 tipos de especias | Poivriere manuel pour 2 types d'epices
Plastica, acciaio | Plastic, steel | Plástico, acero | Plastique, acier

Ø 4,5 x 19 cm S27 L11 2,5 x 2,5 cm

40

71037 *caralluma*

Macina sale/pepe | Salt/pepper grinder | Pimentero/Salero | Sel et poivre
Bamboo | Bamboo | Bambú | Bamboo

15,5 x Ø 5,2 cm S27 L10 T8 3 x 2 cm

1/36

71011 *ingor*

Sal e pepe due in uno | Salt and pepper (two in one) | Set sal y pimenta | Set sel et poivre
Acciaio inox | Stainless steel | Acero inoxidable | Acier inoxydable

15,3 x Ø 2,7 cm S27 L11 3 x 1 cm

1/100

PEPPER grinder



.02



75053 *norsberg*

Macina sale/pepe | Salt/pepper grinder | Molinillo sal/pimienta | Moulin à poivre/sel
Plastica | Plastic | Plástico | Plastique

18 x Ø 4 cm 2 x 2 cm 100



.08



72006 *olt*

Timer da cucina | Timer | Temporizador | Minuteur
Plastica | Plastic | Plástico | Plastique

7 x Ø 5,5 cm T7 1 x 1 cm 1/100



.02



72004 *jan*

Timer Uovo da cucina | Kitchen timer | Temporizador de cocina en forma de huevo | Minuteur de cuisine en forme d'oeuf
Plastica | Plastic | Plástico | Plastique

6 x 6 x 7,5 cm T7 1 x 1 cm 1/100



.32

29986 fairfield

Dosa spaghetti | Spaghetti doser | Medidor raciones espaguetis | Doseur spaghetti
Metallo | Metal | Métal | Métal

6,2 x 18,4 cm L7 4 x 0,08 cm 25/150



Home
198



.02



.29

.07

.23

.08

75029 jai

Molletta stampabile | Printable peg | Pinza | Pince imprimable
Legno | Wooden | Madera | Bois

7 x 1 x 1 cm T6 Ø 1 cm 100/1000



.21

.04

.05

.08

82710 anwandbar

Pinza per sacchetto | Clip for bags | Clip para bolsa | Clip
ABS | ABS | ABS | ABS

10 x 6,2 x 2,2 cm T6



kyoga

49095 kyoga

Dispenser di caramelle. Circa 50 Caramelle Menta Senza Zucchero (6,5 gr.) | Candy dispenser. About 50 Sugar-Free Mints (6,5 gr.) | Dispensador caramelos. Aprox. 50 Caramelos Menta Sin Azúcar (6,5 gr.) | Distributeur de bonbons. Environ 50 Bonbons à la Menthe Sans Sucre (6,5 gr.)

Plastica | Plastic | Plástico | Plastique

Ø 1,9 x 7,5 cm T7 3 x 1 cm 100 / 500



.06

.05

.04

.02

.08



.08



.06

.01

.05

.02

.04

49300 ruby

Custodia con ca. 70 mentine senza zucchero | Candy dispenser with ab. 70 sugar free mints | Confección de 70 caramelos de menta sin azúcar | Petite boîte contenant 70 menthe sans sucre

Metallo | Metal | Metal | Métal

Ø 4,6 x 1,5 cm T7 Ø 4 cm 1 / 500

Home
199



74449 allemansrätten

Shaker 550 ml | Cocktail shake 550 ml | Coctelera 550 ml | Shaker cocktails 550ml
Stainless Steel | Stainless Steel | Acero inoxidable | Acier inoxidable

☞ 8,7 x 21,5 cm ☞ L10



74088 enif

Shaker 300 ml | Shaker 300 ml | Coctelera 300 ml | Shaker 300 ml.
Plastica | Plastic | Plástico | Plastique

☞ 17 x 8 cm ☞ T29 4 x 2 cm ☞ 80



HAPPYhour



75044 orsk

Agitatore | Drink stirrer | Agitador | Agitateur
Plastica | Plastic | Plástico | Plastique

☞ 21 x 3 x 0,4 cm ☞ T1 1,2 x 1,2 cm ☞ 100 / 1200



74106 aspidiske

Bicchiere 500 ml | Glass 500 ml | Vaso 500 ml | Verre 500 ml
PP

☞ 11,6 x 9,2 cm ☞ T20 5 x 2 cm ☞ 500



74102 algieba

Bicchiere 300 ml | Glass 300 ml | Vaso 300 ml | Verre 300 ml
PP

☞ 15,2 x 5,9 cm ☞ T20 5 x 1,5 cm ☞ 500



73002 enis

Accendino usa e getta | Disposable lighter | Encendedor de usar y tirar | Briquet emploi jetable
Plastica | Plastic | Plástico | Plastique

8 x 2,5 x 1 cm T6 | UV2 4 x 1 cm 50/1000



73011 miramar

Accendino con apribottiglia | Lighter and bottle opener | Mechero y abrebotellas | Briquet et ouvre-bouteille
PVC

9 x 2,3 cm T6 | UV2 4,5 x 1,5 cm 50/1000



.23



.02

.01

.08

49970 fide

Portafoto per foto 10x15 cm | Photo frame for 10x15cm photos | Marco para foto 10x15 cm | Porte photo pour photo 10x15 cm
Legno | Wood | Madera | Bois

14 x 19 x 0,9 cm T7 4 x 1 cm 1/40

Home
202

LIGHTER



73048 baki

Accendigas ricaricabile | Refillable lighter. Gas excluded | Encendedor recargable | Briquet rechargeable
Plastica | Plastic | Plástico | Plastique

10,5 x 3,4 x 3 cm T6 | UV2 4 x 2 cm

25/500



.01

.32

73013 bora

Accendino tipo zippo in astuccio | Lighter in box | Encendedor en estuche | Briquet dans étui
Metallo | Metal | Metal | Métal

3,7 x 5,7 cm T7 | L22 2 x 2 cm

50/200



.21

79066 jem

Posacenere in vetro | Glass ashtray | Cenicero en cristal | Cendrier en verre
Vetro | Glass | Vidrio | Verre

Ø 10 x 3 cm T18 Ø 4 cm 12/72

PHOTO frame

Home
203



.32

49968 flyn

Portafoto, foto 10x15 cm | Photo frame, photo 10x15 cm | Marco para foto 10x15 cm | Porte photo, photo 10x15 cm
Alluminio | Aluminium | Aluminio | Aluminium

16 x 10 x 2 cm T8 | L10 6 x 1 cm 1/48



79084 mole

Candela click clack, aroma vaniglia | Vanilla scented candle | Vela aroma vainilla | Bougie parfumée vanille
Metallo | Metal | Metal | Métal

📏 4,6 x 1,4 cm 🕯️ T7 Ø 4 cm 📦 1/400



FRAGRANT candle



79039 lin

Candela cuore in scatola regalo | Heart shaped candle in gift box | Vela corazón en estuche de regalo | Bougie en forme de coeur en paquet cadeau
Cera | Wax | Cera | Cire

📏 9,3 x 9,3 x 2,2 cm 🕯️ S95 2 x 2 cm 📦 50/200

79077 baltisk

Candela profumata | Fragrant candle | Fragrant candle | Bougie parfumée
Metallo | Metal | Metal | Métal

📏 6,3 x 3 cm 🕯️ T7 Ø 3 cm 📦 100



79012 dorò

Candela in scatola con coperchio trasparente | Candle in tin with transparent lid | Vela en cajita metálica con tapa transparente | Bougie en boîte avec couvercle transparent
Metallo | Metal | Metal | Métal

📏 6 x 4,2 cm 🕯️ T7 | L16 Ø 2 cm 📦 24/96



79007 els

Candela profumata di caffè 11 - vaniglia 02 in scatola rivestita in corda | Aroma candle in tin. Fragrance: caffè 11 and vanilla 02 | Vela perfumada en cajita con adorno de cuerda. Aromas: café 11 y vainilla 02 | Bougie parfumée avec décoration en corde en boîte individuelle. Arome café 11 ou vanille 02
Metallo | Metal | Metal | Métal

📏 6 x 5 cm 🕯️ T7 | L16 Ø 3,5 cm 📦 24/96



79056 shanice

Set incenso con candela | Incense set with candle | Set incienso con vela | Set encens avec bougie
Ceramica | Ceramic | Céramica | Céramique

📏 11,4 x 3 x 9,4 cm 🕯️ S27 5 x 3 cm 📦 10/50

79085 *kisale*

Diffusore per ambiente. Aroma gelsomino 15 ml | Aromatic diffuser. Jasmine arôme 15 ml. | Difusor aromático. Aroma Jazmin. 15 ml | Diffuseur aromatique. Aroma Jasmin. 15 ml
Legno | Wood | Madera | Bois

15,7 x 9 x 4,2 cm S27 2 x 2 cm 50 / 100



HOME FRAGRANCES *set*



79071 *soini*

Deodorante per ambienti con bastoncini, 10 ml | Essence pomander, 10 ml | Ambientador, 10 ml | Set diffuseurs, 10 ml
Cartone, PVC | Carton, PVC | Cartón, PVC | Carton, PVC

2,7x2,7x13 cm S27 3 x 2 cm T8 2 x 2 cm 25/150

79072 *hartola*

Deodorante per ambienti spray, 100 ml | Home fragrance, 100 ml | Ambientador, 100 ml | Diffuseur, 100 ml
Cartone, PVC | Carton, PVC | Cartón, PVC | Carton, PVC

4,3 x 4,3 x 14 cm S27 3 x 2 cm T8 5 x 5 cm 25/50



79090 *tarva*

Set profumatore e candela | Set with air freshener and candle | Set de ambientador y vela | Set diffuseur et bougie
Vetro, paraffina | Glass, paraffin | Cristal, parafina | Verre, paraffine

16,5 x 17,5 x 6 cm S27 2,5 x 3 cm 12

79073 *tammela*

Set per profumazione ambienti con incenso, candela, sacchetto e contagocce | Home fragrances set | Juego de ambientador esen caja de regalo | Set diffuseurs dans sa boîte cadeau
Cartone, Vetro | Carton, glass | Cartón, vidrio | Carton, Verre

17,5 x 5,5 x 14,5 cm S86 5 x 3 cm 25

RAE

love LIKE

Ombrelli manuali, automatici, pieghevoli, antivento e antigoccia.
Ombrelli con luce, classici, fluorescenti e dal desing innovativo.
Impermeabili per adulti, bambini e poncho.

208 - 233

pioggia - rain - lluvia - pluie

REV ERSE UMBRELLA



.04

.23

.08

.19

91034 *giustino*

Ombrello anti vento, anti goccia con manico "mani libere" |
Reverse folding umbrella | Paraguas Reversible | Parapluie
tempête anti-vent
Poliestere Pongee | Polyester pongee | Poliéster Pongee |
Polyester Pongee

☒ Ø 107 x 80 cm ☔ S33 | TR25 15 x 10 cm 📦 10/20



90056 *ranarp*

Ombrello golf automatico pieghevole con manico a lucchetto | Fold automatic umbrella with padlock handle | Paraguas automático plegable con manillar estilo candado | Parapluie golf automatique pliable avec poignée avec mousqueton
 Poliestere 190T, fibra di vetro | Polyester 190T, fiber glass | Poliéster 190T, fibra de vidrio | Polyester 190T, fiberglass

☒ Ø 120 cm 💧 S32 10 x 10 cm 📦 36



90004 *yankel*

Ombrello automatico, manico ergonomico in EVA. Custodia inclusa | Automatic umbrella with ergonomic EVA handle. Case included | Paraguas automático con mango ergonómico en EVA. Funda incluida | Parapluie automatique, ergonomique poignée en EVA. Pochette incluse
 Poliestere | Polyester | Poliéster | Polyester

☒ Ø 98 cm 💧 S32 | TR24 15 x 10 cm 📦 10/30



90505 *flisat*

Ombrello antivento | Windproof umbrella | Paraguas antiviento | Parapluie anti-vent
 Pongee | Pongee | Pongee | Pongee

☒ Ø 100 cm 💧 S32



90032 *playfulnes*

Ombrello pieghevole con fodera. Apertura manuale. | Fold umbrella with pouch. Manual opening. | Paraguas plegable con funda. Apertura manual | Parapluie pliable avec étui. Ouverture manuelle.
 Poliestere 190T, alluminio | Polyester 190T, aluminium | Poliéster 190T, aluminio | Polyester 190T, aluminium

☒ Ø 95 cm 💧 S32 10 x 10 cm 📦 60



.07



.08

.01

.23

.04

90020 *roman*

Ombrello pieghevole con interno in colore silver | Folding umbrella with silver inside part | Paragua plegable con el interior plateado | Parapluie pliable avec intérieur argenté

Poliestere 170T | Polyester 170T | Poliéster 170T | Polyester 170T

☒ Ø 95 cm ☂ S32 | TR24 15 x 10 cm 📦 10/60



.01



.05

90012 *quirina*

Ombrello pieghevole automatico con manico curvo in legno | Automatic folding umbrella with wooden handle | Paraguas plegable con asa de madera | Parapluie pliable automatique avec poignée en bois

Nylon 170 T

☒ Ø 106 cm ☂ S32 | TR24 15 x 10 cm 📦 30/60

Rain
212



.08



.17

.23

.07

.02

.08

.01

.05

.04

90009 *rig*

Ombrello pieghevole con fodera | Folding umbrella with pouch | Paraguas plegable con funda | Parapluie pliable avec pochette

Poliestere 170T | Polyester 170T | Poliéster 170T | Polyester 170T

☒ Ø 98 cm ☂ S32 | SP4 TR24 (only on white product) | TR24

15 x 10 cm 📦 10/60



.01



90050 *portis*

Ombrello pieghevole antivento con fodera. Apertura e chiusura automatiche. Manico di gomma con elastico | Windproof fold umbrella with pouch. Automatic opening and closure. Rubber handle with elastic | Paraguas antiviento plegable con funda. Apertura y cierre automáticos. Con manillar de goma con elástico | Parapluie pliable antivent avec étui. Ouverture et fermeture automatique. Poignée gommée avec élastique.

Poliestere 190T, fibra di vetro | Polyester 190T, fiber glass | Poliéster 190T, fibra de vidrio | Polyester 190T, fiberglass

☒ Ø 100 cm ☂ S32 10 x 10 cm 📦 60



90026 *sava*

Ombrello con apertura automatica | Automatic umbrella
| Paraguas automático | Parapluie ouverture automatique
Poliestere | Polyester | Poliéster | Polyestere

☂️ Ø 100 cm 🌧️ S32 | TR24 15 x 10 cm 📦 12/60

Rain
214



90028 *sena*

Ombrello con luce | Umbrella with light | Paraguas con luz
| Parapluie avec lumier
Poliestere | Polyester | Poliéster | Polyestere

☂️ Ø 100 cm 🌧️ TR24 15 x 10 cm 📦 12/60



nyon



91019 *nyon*

Ombrello pieghevole automatico | Automatic folding umbrella | Paraguas plegable automático | Parapluie
automatique pliant
Poliestere 190T | Polyester 190T | Poliéster 190T | Polyester 190T

☂️ Ø 98 cm 4,5 x (24,5 cm) 🌧️ S32 | SP4 (only on white product) | TR24 15 x 10 cm 📦 30/60

Rain
215



.09

92050 *ribba*

Ombrello automatico arcobaleno | Rainbow automatic umbrella | Paraguas automático arcoiris | Parapluie automatique arc-en-ciel
Pongee 190T, fibra di vetro | Pongee 190T, fiber glass | Pongee 190T, fibra de vidrio | Polyester 190T, fiberglass

☒ Ø 125 cm ☂ S33 5 x 5 cm 📦 60

CLASSIC UMBRELLA



91503 *vidal*

Ombrello classico con apertura automatica, manico in legno, chiusura con velcro | Automatic umbrella with wooden shaft and crook wooden handle. Velcro fastening | Paraguas automático con mango curvo de madera, varillas de metal y cierre velcro | Parapluie classique avec ouverture automatique et poignée en bois. Fermeture à scratch
Poliestere 190T | Polyester 190T | Poliéster 190T | Polyester 190T

☒ Ø 100 x 89 cm ☂ S33 | SP5 (only for white colour) | TR25 15 x 10 cm 📦 25/50



.21

91026 *elbrus*

Ombrello automatico | Automatic umbrella | Paraguas automático | Paraguas automática
POE

☂️ Ø 100 cm 🌧️ S33 15 x 10 cm 📦 10/30

AUTOMATIC umbrella



.09

90501 *sofa*



Ombrello bambino, apertura automatica | Kids automatic umbrella, Paraguas infantil, mango curvo de plástico | Parapluie pour enfant, ouverture automatique
Poliestere | Polyester | Poliéster | Polyester

☂️ Ø 71 cm 🌧️ S33 | TR25 10 x 10 cm 📦 12/60



.04



.07



.06



.23



.08

92020 *silvia*

Ombrello automatico bicolor | Automatic umbrella | Paraguas automatico | Parapluie automatique bicolore
Poliestere, Plastica | Polyester, Plastic | Poliéster, Plástico | Polyester, Plastique

☂️ Ø 102 cm 🌧️ S33 | TR25 15 x 10 cm 📦 1/50



91029 *guspini*

Ombrello automatico in fiberglass e manico in Eva | Automatic umbrella in fibre glass ribs and shaft and EVA handle | Paraguas automático en fibra de vidrio y mango en EVA | Parapluie automatique en fiberglass Poliestere 190T | Polyester 190T | Poliéster 190T | Polyester 190T

☂️ Ø 104 cm 🌧️ S33 | TR25 15 x 10 cm 📦 12/24



91037 *poppig*

Ombrello manuale con struttura in fibra di vetro colorata e custodia con profili in tinta | Manual umbrella with fiber glass structure colored with pipping cloth pouch | Paraguas manual con estructura en fibra de vidrio de color y funda del mismo color | Parapluie manuel avec structure en fiberglass colorée. Poignée gommée.

Poliestere 190T, fibra di vetro | Polyester 190T, fiber glass | Poliéster 190T, fibra de vidrio | Polyester 190T, fiberglass

☂️ Ø 105 cm 🌧️ S33 10 x 10 cm 📦 60



Rain
220



91040 *elbes*

Ombrello automatico con manico in EVA | Automatic umbrella with EVA handle | Paraguas automático con mango en EVA | Parapluie automatique avec poignée en EVA

Poliestere 190T | Polyester 190T | Poliéster 190T | Polyester 190T

☂️ Ø 103 cm 🌧️ S33 | TR25 15 x 10 cm 📦 10/30



WHEN I HAVE
NO MORE BLUE,
I put red



91507 *nocciola*

Ombrello automatico con manico in EVA | Automatic Umbrella with EVA Handle | Paraguas automático con mango en EVA | Parapluie automatique avec poignée en EVA | Poliestere | Polyester | Poliéster | Polyester

☒ Ø 105 cm ☂ S33 | TR25 15 x 10 cm

📦 25



nocciola



92067 *regissör*

Ombrello Maxi golf automatico con struttura in fibra di vetro. Manico di gomma con pulsante argentato | Automatic umbrella with fiber glass structure. Rubber handle with silver button | Paraguas automático con estructura de fibra de vidrio. Manillar de goma con botón plateado | Parapluie golf automatique avec structure en fibreglass. Poignée gommée avec bouton argenté.

Pongee 190T, fibra di vetro | Pongee 190T, fiber glass | Pongee 190T, fibra de vidrio | Polyester 190T, fibreglass

☒ Ø 135 cm ☔ S33 10 x 10 cm 📦 36



91020 *oceanside*

Ombrello automatico | Automatic umbrella | Paraguas automático | Parapluie automatique
Poliestere/eva

☒ Ø 125 cm ☔ S33 | SP5 (only for white colour) | TR25 15 x 10 cm 📦 36



92008 *rosa*

Ombrello golf XL manuale, asta in metallo, manico in legno | Manual golf umbrella XL with metal shaft and wooden handle | Paraguas XL manual con mango recto de madera caña y varillas metálicas y cierre botón | Parapluie XL avec ouverture manuelle et poignée en bois

Poliestere | Polyester | Polièstere | Polyester
☒ Ø 130 x 105 cm ☔ S33 | SP5 (only for white colour) | TR25 15 x 10 cm 📦 10/20





91012 *pedro*

Ombrello manico ergonomico, EVA, fodera inclusa | Umbrella with ergonomic EVA handgrip with pouch | Paraguas mango ergonómico, EVA, incluye funda | Parapluie avec poignée ergonomique
 Poliestere, Eva | Polyester, Eva | Poliéster, EVA | Polyester, EVA

☒ Ø 105 cm ☂ S33 15 x 10 cm 📦 10 / 30



91055 *rimforsa*

Ombrello automatico con struttura in fibra di vetro nera. | Automatic umbrella with black fiber glass structure. | Paraguas automático con estructura de fibra de vidrio negra. | Parapluie automatique avec structure en fiberglass noire
 Poliestere pongee 190T, fibra di vetro | Polyester pongee 190T, fiber glass | Poliester pongee 190T, fibra de vidrio | Polyester 190T pongee, fiberglass

☒ Ø 105 cm ☂ S33 10 x 10 cm 📦 60

Rain
226



91035 *pokal*

Ombrello automatico neon/fluo | Automatic umbrella fluo | Paraguas automático color fluo | Parapluie automatique fluo
 Poliestere 190T, alluminio | Polyester 190T, aluminium | Poliéster 190T, aluminio | Polyester 190T, aluminium

☒ Ø 105 cm ☂ S33 10 x 10 cm 📦 60



Rain
227

RAIN

91050 *rågrund*

Ombrello asimmetrico modello ala | Asymmetric wing umbrella | Paraguas asimétrico modelo ala | Parapluie asymétrique
Pongee 190T, fibra di vetro | Pongee 190T, fiber glass | Pongee 190T, fibra de vidrio | Polyester 190T, fiberglass

📏 96 x 92 cm 💧 S33 10 x 10 cm 📦 60

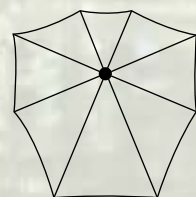

91058 *samla*

Ombrello automatico con fodera e rivetti di metallo | Automatic umbrella with pouch and metal rivets | Paraguas automático con remaches de metal | Parapluie automatique avec étui et détails chromés. | (16 panels)

Pongee 190T, fibra di vetro | Pongee 190T, fiber glass | Pongee 190T, fibra de vidrio | Polyester 190T, fiberglass

📏 Ø 115 cm 💧 S33 10 X 10 cm 📦 50

.01



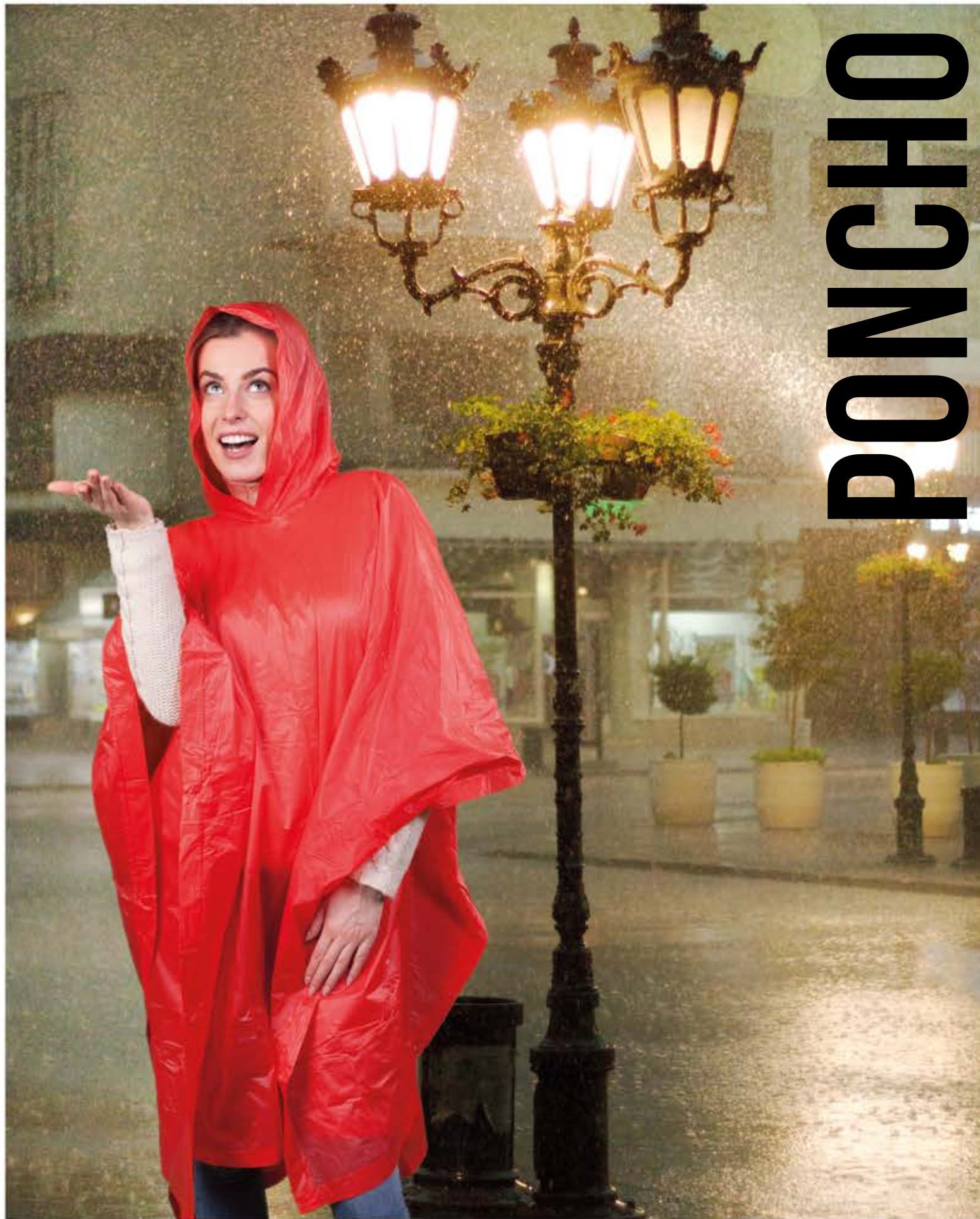

PONCHO



93004 *tajo*

Poncho taglia unica, 300 gr. | Poncho one size fits all, 300 gr.
| Poncho talla única, 300 gr. | Poncho taille unique, 300gr.
PVC

📏 135 x 100 cm 💧 S21 20 x 20 cm 📦 1/50



93037 *cosmea*

Poncho da bambino | Children poncho | Poncho niño | Poncho pour enfants
PVC

📏 64 x 90 cm 💧 S21 20 x 20 cm 📦 10/50



93040 *victo*

K-way, 2 tasche frontali | Raincoat with 2 front pockets |
Impermeabile con bolsillos | Impérmeable avec 2 poches
PVC

📏 M/L - XL/XXL 💧 S21 20 x 20 cm 📦 1/50



93035 *orb*

Impermeabile | Raincoat adult size | Impermeable
adulto | Imperméable
PVC

📏 M/L - XL/XXL 💧 S22 20 x 20 cm 📦 1/30



93018 *gabu*

Impermeabile, taglia unica, inclusa custodia |
Raincoat one size fits all, in pouch | Chubasquero
talla única en funda | Impérmeable taille unique,
housse incluse
EVA

💧 S21 20 x 20 cm 📦 10/50



93038 *giovo*

Giacca impermeabile con cappuccio e polsino con elastico. | Waterproof jacket with hood and elastic cuffs | Chaqueta impermeable con capucha y puños con elástico | Veste imperméable avec capuche et poignets avec élastique
PVC

Available Colours: 33, 04 (picture Men and Woman)
UNISEX

Close XL ☔ S22 20 x 20 cm 1/40

93043 *robonic*

Giacca impermeabile imbottito con cappuccio e polsino con elastico. | Waterproof quilted jacket with hood and elastic cuffs | Chaqueta acolchada impermeable con capucha y puños con elástico | Veste matelassée imperméable avec capuche et poignets avec élastique
PVC

Available Colours: 04 (picture Men)
UNISEX

Close M / XL (Assorted sizes) ☔ S22 20 x 20 cm 1/20



93016 *robot*

Poncho bimbo pieghevole in capsula | Foldable child poncho in round box | Poncho niño transparente plegable en caja | Poncho enfant pliable en capsule
PVC

Close Ø 6 cm Size 12-13 anni ☔ T7 Ø 1,5 cm 25/200



93002 *tabo*

Poncho adulto pieghevole in capsula | Foldable adult poncho in round box | Poncho adulto transparente plegable en caja | Poncho adulte pliable en capsule
PVC

Close Ø 6.4 cm ☔ T7 Ø 2 cm 25/200

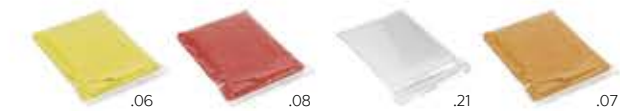

93001 *turi*

Poncho pieghevole, trasparente | Foldable poncho in polybag | Poncho impermeabile plegable en bolsa de plástico | Poncho pliable, transparent
PVC

127 x 140 cm DP2 10 x 9 cm 1/200



93005 *dattero*

Impermeabile da adulto | Raincoat adult Size | Impermeable de adulto | Poncho taille adulte dans son étui
PEVA

19 x Ø 6 cm ☔ S21 20 x 20 cm 50

PERSONAL

make the DIFFERENCE

Set per manicure, set bagno per bambini e set di pennelli da trucco. Specchietti da borsa, spazzole, scaldamani istantanei, spazzolini, beauty casa da viaggio e cravatte. Supporti per cellulari, porta carte di credito, porta monete, porta chiavi e molto altro ...

234 - 317

personal



Personal
235

43916 *uppfatta*

Pochette con cerniera | Beauty case with zip | Neceser con cremallera | Pochette avec fermeture éclair
Neoprene | Neoprene | Neopreno | Neoprène

23,5 x 9 x 13 cm 40 S8 13 x 5 cm 40



43143 *benagil*

Pochette trasparente con soffiato | Transparent beauty case | Neceser transparente con fuelle | Pochette transparente avec soufflet PVC

11,9 x 4,5 x 14 cm S8 6 x 6 cm 500



43124 *genga*

Beauty case con chiusura a zip a pressione | Toilet kit with zip | Neceser con cremallera | Trousse de toilette fermeture éclair EVA (PVC Free) | EVA (PVC Free) | EVA | EVA (sans PVC)

14 x 9 x 2 cm S8 5 x 5 cm 50/200



43149 *cardiel*

Beauty case | Beauty case | Neceser | Beauty case (accessories excl.) EVA | EVA | EVA | EVA

27 x 7 x 16 cm S8 14 x 7 cm 20 / 400



43136 *giarole*

Pochette trasparente con cerniera | Clutch bag | Neceser | Trousse de toilette Cotone | Cotton | Algodon | Coton

36 x 35 x 9 cm S8 6 x 6 cm 1/100

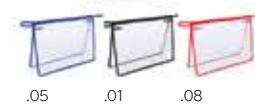

43139 *colchico*

Pochette trasparente | Clutch bag | Neceser | Pochette transparente Pvc

29 x 21 x 9 cm S8 10 x 10 cm 50/100



43110 *shadu*

Trousse transparente | Transparent clutch bag | Neceser transparente | Etui transparent PVC

20 x 4 x 18,5 cm S8 6 x 6 cm 20/400

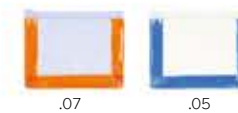

43009 *ilda*

Pochette trasparente con soffiato | Transparent beauty case | Neceser trasparente con fuelle | Pochette transparente avec soufflet PVC

17 x 4,5 x 13 cm S8 5 x 5 cm 1/1000



43082 *sina*

Astuccio trasparente | Transparent clutch bag | Neceser trasparente | Étui transparent Plastica | Plastic | Plástico | Plastique

17 x 18 x 7 cm S8 5 x 5 cm 50/200



.18



.01

.06

.19

43035 rufus

Beauty case | Clutch bag | Neceser | Beauty case
Microfibra | Microfibre | Microfibre | Microfibre

21 x 13 x 8,5 cm S8 | TR1 5 x 5 cm 50/250



.05



.29

.13

.17

.01

.08

43092 ogier

Beauty case | Cosmetic bag | Neceser | Sac cosmétique
Poliestere 600D | Polyester 600D | Poliéster 600D | Polyester 600D

13,5 x 9,5 x 5 cm S8 | TR1 7 x 2 cm 50/200



.06



.17

.01

.08

.02

43138 gallarate

Pochette con cerniera | Clutch bag | Neceser | Trousse de toilette
Microfibra | Microfibre | Microfibra | Microfibras

18 x 12 x 5 cm S8 10 x 5 cm 10/50



.17



.13

.01

64156 lustenau

Beauty case | Cosmetic bag | Neceser | Pochette
Rasatello | Sateen | Satén | Satinette

18 x 14 x 10 cm S8 10 x 5 cm 60

relf



.05



.13

.08

.17

.07

.01

43080 relf

Pochette per make-up con zip | Make-up clutch bag with zip | Bolsita de
maquillaje con cremallera | Pochette pour maquillage avec fermeture
éclair

Poliestere | Polyester | Poliéster | Polyester

22 x 7,6 cm S8 | TR1 8 x 4 cm 20/300





40166 *undredal*

Pochette squadrata con manico | Beauty case with handle |
Neceser cuadrado con asa | Pochette avec hanse
Neoprene | Neoprene | Neopreno | Neoprène

18 x 8 x 11 cm S8 10 x 5 cm 30



43105 *caroline*

Trousse | Cosmetic bag with handle | Neceser | Pochette
Poliestere 600D | Polyester 600D | Poliéster 600D | Polyester 600D

21,5 x 14 x 10 cm S8 | TR1 10 x 5 200



43087 *solberg*

Beauty case da viaggio con zip | Travel cosmetic bag with zip |
Estuche con cremallera por viajes | Voyage sac cosmétique avec zip
Poliestere 600D | Polyester 600D | Poliéster 600D | Polyester 600D

35 x 20,5 cm S9 7 x 2 cm 50/200



Personal
240



43065 *anne*

Sacca da toilette con doppio scomparto interno e tasca esterna |
Bath bag with external and internal pocket | Estuche de baño con
doble bolsillo interno y bolsillo externo | Pochette de toilette avec
poche interne et externe
Polyester 600D, PU

28 x 16 x 7 cm S8 | TR1 4 x 2 cm 50/200



43145 *roques*

Beauty da viaggio con diversi scomparti e tasche. Con gancio per
appenderlo | Beauty case with many compartments and pockets.
With hook to hold | Neceser de viaje con numerosos compartimentos
y bolsillos. Con gancho para colgar | Beauty case de voyage avec
plusieurs compartiments et poches avec accroche
Poliestere 600D | Polyester 600D | Poliéster 600D | Polyester 600D

27,5 x 8 x 24 cm T8 15 x 10 cm 70



43146 *ke'e*

Pochette con manico unico sul fianco | Beauty case with handle on
one side | Neceser con asa única en un lado | Pochette avec poignée
sur le côté
Poliestere 600D | Polyester 600D | Poliéster 600D | Polyester 600D

17 x 5,5 x 15 cm T6 10 x 8 cm 200

Personal
241



43915 arv

Pochette con cerniera | Beauty case with zip | Neceser con cremallera | Pochette avec fermeture éclair
 Poliestere | Polyester | Poliéster | Polyester
 22 x 14 x 6,5 cm S8



43132 kuggake

Pochette con cerniera | Clutch bag | Neceser | Trousse de toilette
 Mixed (38% Cotton, 40% Polyester, 22% Rayon)
 32 x 10 x 20 cm S8 10 x 5 cm 1/200



43019 zoe

Pochette | Clutch bag | Neceser | Pochette
 Feltro | Felt | Fieltro | Feutre
 20 x 12 x 6 cm S8 | TR1 8 x 4 cm 20/200



43118 kirob

Beauty case | Clutch bag | Neceser | Beauty case
 Neoprene
 25 x 14 x 9 cm S8 6 x 6 cm 1/100



43040 sami

Borsa per cosmetici | Cosmetic beauty case | Neceser |
 Pochette maquillage
 Microfibra, Semilpelle | Microfibre, Imitation leather | Microfibre,
 Polipiel | Microfibre, Similicuir
 18 x 13 x 9,5 cm S8 | TR1 3 x 2 cm 50/250



41122 gattelli

Pochette con cerniera | Beauty case with zip closing | Neceser con cremallera | Pochette
 avec fermeture éclair
 Nylon | Nylon | Nailon | Nylon
 20 x 10 x 10 cm S8 10 x 7 cm 50/100





.06

43127 *mazinga*

Beauty case con cerniera | Beauty case with zip closing | Necesar con cremallera | Étui avec fermeture éclair
Juta | Jute | Yute | Jute

25 x 16 x 6 cm S8 15 x 6 cm 1/50



.23



.17



.01



43147 *sinnlig*

Pochette con cerniera colorata | Beauty case with coloured zip | Necesar con cremallera de color | Pochette avec fermeture éclair colorée
Cotone | Cotton | Algodón | Coton

23 x 15,5 x 6 cm S8 10 x 6 cm 20 / 200



.13



.23



.08



.07



.06



.05

43917 *utrusta*

Pochette bicolore con cerniera | Beauty case bicolored with zip | Necesar bicolor con cremallera | Pochette bicolore avec fermeture éclair
Cotone 220gr | Cotton 220gr | Algodón 220gr | Coton 220gr

23 x 18 x 8 cm S8 14 x 7 cm 250



.00



.23

.07

.19

.17

43134 *giavenco*

Pochette | Clutch bag | Necesar | Trousse.
Yuta | Jute | Yute | Jute

25 x 15 cm S8 10 x 7 cm 50/100



.07

.19

.06

.05

43150 *chinchón*

Pochette | Clutch bag | Necesar | Trousse.
Yuta | Jute | Yute | Jute

25,5 x 21,5 cm S8 14 x 12 cm 10 / 250



.32



.29



43091 *kyra*

Astuccio | Clutch bag | Necesar | Pochette
PVC laminato | Laminated PVC | PVC plastificado | PVC stratifié
13 x 9 x 6 cm S8 7 x 5 cm 50/100

43013 *steffi*

Porta trucchi con specchio | Cosmetic bag with mirror | Necesar con espejo | Trousse avec miroir
PVC
18 x 12,2 x 2,5 cm S8 6 x 4 cm 10/500



CLUTCH *bag*

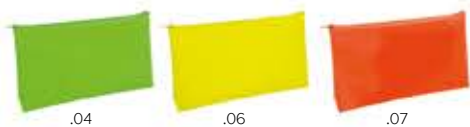

43144 *lillången*

Pochette con cerniera | Beauty case with zip | Necesar con cremallera | Pochette avec fermeture éclair
PVC | PVC | PVC | PVC
19,5 x 10 x 2,5 cm T7 500



.17



.32



43135 *gessate*

Pochette | Clutch bag | Necesar | Trousse.
PU
18,5 x 11,5 x 2,5 cm S8 10 x 5 cm 50/400



.31



43140 *coleus*

Pochette | Clutch bag | Necesar | Trousse.
Pvc
15 x 7 x 7 cm S8 8 x 5 cm 50/400



44020 *lime*

Set manicure, 5 pezzi | Manicure set, 5 pcs | Set manicura set, 5 piezas
 | Set manicure, 5 pièces
 Nylon, Metallo | Nylon, Metal | Nylon, Metal | Nylon, Métal

📏 5,5 x 14 x 1 cm 🌿 S95 2 x 2 cm 📦 50/200



44036 *paul*

Set manicure, 4 pezzi | Manicure set, 4 pcs | Set manicura, 4 piezas
 | Set manicure, 4 pièces
 Nylon, Metallo | Nylon, Metal | Nylon, Metal | Nylon, Métal

📏 4,8 x 9,7 x 3 cm 🌿 S95 3 x 2 cm 📦 50/200



44030 *david*

Set manicure per uomo, 8 pezzi | Manicure set for men, 8 pieces | Set
 manicure para hombre, 8 piezas | Set manicure pour homme, 8 pièces
 Similpelle, metallo | Imitation leather, metal | Polipiel, metal | Simil-cuir, métal

📏 11 x 17 x 3 cm 🌿 S2 2 x 2 cm 📦 12/144



44023 *nina*

Set manicure, 4 pezzi | Manicure set, 4 pcs | Set manicura set, 4 pzs
 | Set manicure, 4 pièces
 Plastica | Plastic | Plástico | Plastique

📏 10 x 5,4 x 2,1 cm 🌿 S2 | UV2 4 x 2 cm 📦 60/240



44033 *guardavalle*

Set per manicure | Manicure set | Set de manicura | Set manicure
 Plastica, metallo | Plastic, Metal | Plástico, metal | Plastique, Métal

📏 6,6 x 10,5 cm 🌿 S95 3 x 3 cm 📦 50/200



44032 *mary*

Set manicure, 4 pezzi | manicure set, 4pcs | Set manicura , 4 piezas
 | Set manicure, 4 pièces
 Alluminio | Aluminium | Aluminio | Aluminium

📏 4,8 x 9,7 x 3 cm 🌿 T8 | L7 3 x 1,5 cm 📦 36/144



82600 *variera*

Pennello da barba | Beard brush | Brocha de afeitar | Pinceau à barbe
 Legno, poliester | Wood, polyester | Madera, poliéster | Bois, polyester

📏 Ø 3,4 x 11 cm 🌿 T7 2,5 x 1,5 cm 📦 600



42115 *varv*

Rasoio intagliato | Engraved razor blade | Cuchilla de afeitar labrada |
 Rasoir entaillé
 Metallo | Metal | Metal | Métal

📏 4 x 9 cm 🌿 S27 2,5 x 1 cm 📦 200



MAKE UP Brushes



.05



.01

.08

44001 grete

Set pennelli per trucco, 4 pz | Make-up brushes set, 4 pcs |
Set pinceles para maquillaje, 4 pcs | Ensemble pinceaux pour
maquillage, 4 pièces

Plastica | Plastic | Plastico |Plastique

15 x Ø 1,8 cm T7 3 x 1 cm 50/600



.02

.01

44047 vesanto

Kit di trucco con 5 pennelli | Makeup brush set. Includes 5
makeup brushes | Estuche de maquillaje. Incluye 5 pinceles |
Trousse à maquillage, 5 pinceaux inclus

PP

5,3 x 8,2 x 1,4 cm T7 UV3 3 x 3 cm 288



.31

42034 haapsalu

Set da trucco | Make-up set | Set de maquillage | Set de
maquillage

PVC

15 x 1 x 10 cm S95 6 x 3 cm 250



44049 cedrina

Set pennelli per make up | Make-up set | Set de maquillage |
Set pour maquillage

Poliestere, alluminio | Polyester, aluminium | Poliéster, aluminio
| Polyester, aluminium

9 x 3 x 2 cm S93 5 x 1,5 cm 50/300



.01



42041 palombaggia

Pennello da trucco richiudibile | Makeup brush with retractile
handle | Brocha para maquillaje retráctil | Pinceau pour
maquillage pliable

Alluminio | Aluminium | Aluminio | Alluminium

Ø 2 x 12 cm T20 4 x 1 cm 400



.06

.17

.02

.08



42003 *else*

Specchietto da borsa | Pocket mirror | Espejo de bolsillo | Miroir de sac
Plastica | Plastic | Plástico | Plastique

☞ 6 x 0,5 cm ☞ T6 | UV2 Ø 4 cm ☞ 72/720



42024 *bele*

Specchietto con doppio ingrandimento | Double mirror with magnifier |
Espejo con doble ampliación | Double miroir avec agrandissement
Plastica | Plastic | Plástico | Plastique

☞ 7 x 6,5 cm ☞ T7 | UV3 3 x 3 cm ☞ 50/500



42005 *anita*

Specchietto da borsa con doppio ingrandimento | Double mirror
with magnifier | Espejo con doble ampliación | Double miroir avec
agrandissement

Plastica | Plastic | Plástico | Plastique

☞ 6,7 x 1,2 cm ☞ T7 | UV3 Ø 4 cm ☞ 50/500



44019 *carl*

Set cucito con specchio, 4 pezzi | Sewing set with mirror, 4 pieces | Set
costura con espejo, 4 piezas | Set couture avec miroir, 4 pièces
Plastica | Plastic | Plástico | Plastique

☞ 7,5 x 5,4 x 0,4 cm ☞ T7 3 x 3 cm ☞ 50/300



44013 *almur*

Set lime per unghie, 6 accessori | Nail file set, 6 pcs | Set limas, 6
piezas | Set de mini-limas à ongles, 6 pièces
cartone | carton | cartón | carton

☞ 5,6 x 6,3 x 0,4 cm ☞ S2 3 x 3 cm ☞ 100/800



44035 *celia*

Set lime per unghie, 4 pz | Nail file and polish set, 4pcs | Set lima para
uñas, 4 piezas | Set limes pour ongles, 4 pièces
Plastica | Plastic | Plástico | Plastique

☞ 7,5 x 2,1 x 1,2 cm ☞ T6 3 x 1 cm ☞ 50/1000



42013 *ida*

Specchio con pettine | Mirror with comb | Espejo con peine | Miroir
avec peigne
Plastica | Plastic | Plástico | Plastique

☞ 7 x 7 x 1 cm ☞ T7 | UV3 4 x 4 cm ☞ 20/400





42042 *lisabo*

Spazzola per capelli | Hairbrush | Cepillo para el pelo | Brosse pour cheveux
Plastica | Plastic | Plástico | Plastique

7,3 x 18,5 x 3,6 cm T8 4 x 2 cm 100



42043 *grundtal*

Spazzola districante | Detangling brush | Cepillo antienredos | Brosse démêlante
Plastica | Plastic | Plástico | Plastique

9,5 x 7 x 5 cm T7 4 x 3,5 cm 50/100



42004 *ina*

Spazzola pieghevole con specchietto | Foldable hair brush with mirror | Cepillo plegable con espejo | Brosse avec miroir pliable
Plastica | Plastic | Plástico | Plastique

10,7 x 4 x 2,8 cm T6 4 x 1,5 cm 100/400

Personal
254



42111 *zircon*

Spazzola | Hair brush | Cepillo | Brosse
Plastica | Plastic | Plástico | Plastique

9,5 x 7 x 5 cm T7 4 x 3,5 cm 50/100



42114 *galluccio*

Spazzola con specchio | Brush with mirror | Brocha con espejo | Pinceau avec miroir
Plastica | Plastic | Plástico | Plastique

15 x 7,5 x 3 cm T7 3 x 1 cm 50/100

Personal
255



42017 *accra*

Asciugacapelli pieghevole | Foldable hairdryer | Secador de pelo plegable | Sèche-cheveux repliable
Plastica | Plastic | Plástico | Plastique

14 x 20 x 6,8 cm T8 5 x 2 cm 1/20



42112 *bali*

Spazzola | Hair brush | Cepillo | Brosse
Legno | Wood | Madera | Bois

4 x 13,5 cm T6 3 x 1 cm 70/140



42002 *susi*

Specchietto con spazzola richiudibile | Pocket mirror with foldable brush | Espejo con cepillo plegable | Brosse avec miroir pliable
Plastica | Plastic | Plástico | Plastique

6,6 x 2,8 cm T6 UV2 Ø 3 cm 72/288



.21

43029 *janne*

Scaldamani istantaneo. Riutilizzabile | Heat pouch. Instant hot. Reusable
| Calentador de manos instantáneo. Reutilizable | Chauffe-mains instantané. Réutilisable
PVC

10 x 6 x 1 cm S95 7 x 4 cm 50/200



.08

43055 *alike*

Scaldamani a forma di cuore | Heart shaped hands warmer | Calentador de manos en forma de corazón | Chauffe-mains en forme de cœur
PVC

10 x 9 cm S95 2 x 2 cm 50/200



.18

.01

.17

.08

44046 *svante*

Vaporizzatore | Vaporizer | Vaporizador | Vaporisateur
Plastica | Plastic | Plástico | Plastique

8 x Ø 1,5 cm T6 3 x 1 cm 50/1250



.23

.19

43111 *genola*

Custodia GEL caldo/freddo. Utilizzabile nel microwave e nel congelatore |
Hot ans Cold patch | Banda gel efecto calor/frio. | Pochette GEL chaud/
froid. Utilisable au micro-ondes et congélateur
Poliestere | Polyester | Polyester | Polyester

22,5 x 12,5 cm S95 2 x 2 cm 25/50

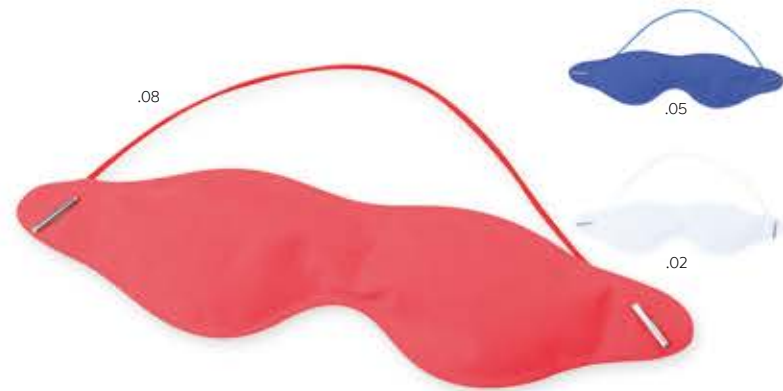

.08

.05

.02

43126 *gallio*

Maschera | Mask | Antifaz | Masque
Nylon | Nylon | Nailon | Nylon

20 x 5,5 cm S95 5 x 2 cm 50/250



.32

.01

44007 *parfar*

Vaporizzatore | Vaporizer | Vaporizador | Vaporisateur
Alluminio | Aluminium | Aluminium | Aluminium

2 x 9 cm T7 3 x 1 cm 25/200



.23

.06

.08

.02

44125 *cattleya*

Burro cacao a pallina | Lips balm | Bálsamo labial | Baume à lèvres
Plastica | Plastic | Plástico | Plastique

Ø 3,8 cm T6 1 x 1 cm 50/500



.23



.08

.06

.17

.02

.19

44011 *loeb*

Balsamo per labbra | Lips balm | Bálsamo labial | Baume à lèvres
Plastica | Plastic | Plástico | Plastique

6,8 x Ø 1,9 cm T6 | UV1 3 x 1 cm 100/2000



TOOTHBRUSH



48234 *sarakiniko*

Spazzolino da denti da viaggio | Travel toothbrush | Cepillo de dientes de viaje | Brosse à dent de voyage
Plastica | Plastic | Plástico | Plastique

10 cm (closed) S3 4 x 1 cm 50



43000 *alsek*

Spazzolino automatico | Automatic toothbrush | Cepillo de dientes automático | Brosse à dents automatique
Plastica | Plastic | Plástico | Plastique

20,2 x 2,7 x 3,5 cm T8 2 x 2 cm 50/100



48004 *sara*

Spazzolino da viaggio richiudibile | Toothbrush in transparent case | Cepillo de dientes con estuche de plástico | Brosse à dent de voyage repliable
Plastica | Plastic | Plástico | Plastique

9 x 2 x 1,5 cm T7 | UV1 4 x 1 cm 180/720



43002 *elias*

Spazzolino da denti, bimbi | Kids toothbrush | Cepillo de dientes, niños | Brosse à dent, enfants
Plastica | Plastic | Plástico | Plastique

3 x 14,6 x 1 cm T8 1 x 1,5 cm 50/500



43133 *greccio*

Spazzolino con clessidra in astuccio trasparente. | Cleaning tooth set. | Set cepillo dientes | Brosse à dent avec sablier dans pochette transparente.
Plastica | Plastic | Plástico | Plastique

8 x 20 x 2 cm S8 3 x 3 cm 50/200



Personal
260

43128 teddy

Spazzolino pieghevole da viaggio | Foldable toothbrush
| Cepillo | Brosse à dent pliable de voyage
Plastica | Plastic | Plástico |

48041 jette

Spazzolino da viaggio richiudibile | Foldable travel toothbrush |
Cepillo de dientes de viaje plegable | Brosse à dent de voyage
pliable
Plastica | Plastic | Plástico | Plastique

11,3 x 1,5 cm T11 4 x 0,8 cm 100/1000



43913 hartford

Clessidra 3 minuti. Supporto a ventosa. Personalizzabile
con inserto di carta. | 3 minute Hourglass with sucker.
Customizable with printed paper insert | Reloj de arena
de 3 minutos con ventosa. Personalizable mediante
introducción de papel estampado. | Sablier 3 minutes
avec ventouse. Personnalizable avec insert en papier
imprimé.

Plastica | Plastic | Plástico | Plastique

6 x Ø 2 cm T6 4 x 1 cm 720

43122 yuni

Clessidra per doccia | Hourglass | Hourglass | Sablier
Plastica | Plastic | Plástico | Plastique

7,5 x 3,5 x 10 cm T8 3,5 x 1 cm 200

43026 cruz

Portaspazzolini con clessidra 3' | Tooth brush with 3'
hourglass | Porta cepillo de dientes con reloj de arena
3' | Porte brosse à dent avec sablier 3"
Plastica | Plastic | Plástico | Plastique

14 x 8,5 x 6,5 cm T8 2 x 2 cm 1/100



46070 iodo

Spugna 20 gr | Sponge 20 gr | Esponja 20 gr | Éponge 20 gr
Vario | Various | Varios | Varié

8 x Ø 9,7 cm S96 | DP2 30,5 x 7,5 cm 1/48

43036 hilla

Set bagno per bambini in zainetto | Children bath set in backpack | Set
de baño para niños en mochila | Set toilette pour enfants
Vario | Various | Varios | Varié

26 x 18 x 9,5 cm DP2 1/30

Personal
261



43120 *ziboro*

Set bagno con bagnoschiuma, shampo, balsamo e lozione per il corpo. 30 ml cadauno | Bath set | Bath set | Set toilette avec bain douche, shampooing, après shampoing et lotion pour le corps

13,5 x 2,5 x 12 cm S93 6 x 6 cm 50



.21



.13

43148 *mozambique*

Set bagno con 4 bottigliette da 30 ml cad. | Set of 4 tubes of 30 ml for bath | Set de neceser de jute y 4 tubos de 30 ml en su interior | Set de toilette avec 4 tubes de 30 ml

Juta | Jute | Jute | Jute

15 x 12 cm S93 10 x 5 cm 40



.13

43121 *rostoshy*

Set bagno con gel doccia e lozione per il corpo in flaconi da 300 ml | Bath set | Bath set | Set toilette avec gel douche et lotion pour le corps

Cotone | Cotton | Algodon | Coton

20 x 23,5 cm S93 10 x 10 cm 20

Personal
262



.32

43119 *skolkovo*

Set bagno con sapone e 2 creme mani da 50 ml | Bath set | Bath set | Set toilette avec savon et 2 crème mains

Metallo | Metal | Metal | Métal

Ø 10,5 x 11 cm S86 4 x 4 cm 20



.01

.13

79443 *balatack*

Saponetta da bagno astucciata | Soap with box | Jabón con caja regalo | Savonnette avec boîte

6 x 5,5 cm S27 3 x 3 cm 50/200



.29

.23



.21



.08

43018 *helge*

Confezione rotonda frosty con 25 foglie di sapone | Frosty round case with 25 soap leaves | Estuche translúcido con 25 láminas de jabón | Boîte ronde, avec 25 feuilles de savon

Plastica | Plastic | Plástico | Plastique

Ø 7 x 1 cm T7 | UV3 Ø 4 cm 20/480

Personal
263



.17

18050 *bauska*

Rosa asciugamano | Rose shaped towel | Toalla con forma de rosa | Serviette à forme de rose

100% Cotone

23 x 5,5 cm AD1 6x1 cm 300



POUCH



43094 urano

Custodia scamosciata | Pouch | Funda | Pochette
Similpelle | Imitation leather | Polipieli | Simili-cuir

8 x 10 cm S2 5 x 5 cm 2000

43098 clematide

Custodia | Pouch | Funda | Pochette
Poliestere | Polyester | Poliéster | Polygester

9,5 x 10 cm S2 5 x 5 cm 3000



41101 pontus

Braccialetto | Bracelet | Pulsera | Bracelot
Plastica | Plastic | Plástico | Plastique

20 cm 100/500



43838 gote

Bustina porta gioielli | Jewellery pouch | Funda regalo
para joyas | Pochette porte bijoux
Poliestere | Polyester | Poliéster | Polygester

10 x 15 x 0,2 cm 100/5000



49063 marten

Collana con piastrina | Chain with tag | Collar con
placa | Plaquettes
Metallo | Metal | Metal | Métal

2,8 x 35 cm L7 2 x 2 cm 10/400



43011 olaf

Massaggiatore | Body massager | Masajeador |
Masseur
Plastica | Plastic | Plástico | Plastique

14,3 x 14,3 x 4 cm T7 Ø 2 cm 50/100



18020 sidas 37 | 39 18022 sidab 41 | 43

Ciabatte | Slippers | Zapatillas | Pantouffes
Cotone | Cotton | Algodón | Coton

37/39 - 41/43 S14 | R 4 x 4 cm 1/100



43836 relaxim

Massaggiatore vibrante USB | USB body massager |
Masajeador con USB | Masseur avec connexion USB
ABS

10,5 x 7 x Ø 7 cm T8 3,5 x 2 cm 100



49091 *ginosa*

Sciarpa | Scarf | Foulard | Echarpe
Viscosa | Viscose | Viscosa | Viscose

180 x 70 cm S9 3 x 3 cm 20/100



49024 *idis*

Reggiborsa da tavolo | Table bag hanger | Gancho de mesa para colgar bolso |
Crochet de table pour sac à main
Metallo | Metal | Metal | Métal

4,2 x 0,6 cm T7 | D10 Ø 3 cm 50/200



17478 *austin*

Sciarpa | Scarf | Pashmina | Echarpe
Rayon | Rayon | Rayón | Rayonne

30 x 180 cm S9 10 x 10 cm 100

Personal
266



49040 *delma*

Astuccio per cravatta | Tie case | Estuche para corbata | Étui pour cravattes
Cartone | Carton | Cartón | Carton

39 x 15,4 cm S2 5 x 5 cm 1/200



49045 *zenz*

Cravatta | Tie | Corbata | Cravatte
Poliestere | Polyester | Poliéster | Polyester

150 cm S9 | TR20 4 x 4 cm 1/100



49049 *rup*

Cintura con chiusura metallica - 110 cm | Belt with metal buckle - 110 cm |
Cinturón con hebilla de metal - 110 cm | Ceinture avec boucle métallique,
110 cm
Poliestere, Metallo | Polyester, Metal | Poliéster, Metal | Polyester, Métal

110 x 4 cm L10 5 x 3 cm 1/100



Personal
267



.21



.05



.08

29080 *brage*

Supporto in plastica flessibile. Fornito steso | Holder, supplied flat | Soporte flexible | Suport en plastique flexible
PVC

7,8 x 6,2 x 4,8 cm S94 2,5 x 2 cm 50/200



.02

41352 *lansing*

Portacellulare personalizzabile su entrambe le facciate | Phone holder customizable on both sides | Porta móvil personalizable en ambos lados | Porte cellulaire personnalisable
Poliestere | Polyester | Polië

13 x 8 cm SP11 10 x 6 cm 1000



.02

50206 *nashua*

Portacellulare personalizzabile su entrambe le facciate | Phone holder customizable on both sides | Porta móvil Personalizable en ambos lados | Porte cellulaire personnalisable des deux côtés
Poliestere | Polyester | poliester Poliëstere

9 x 18 SP1 9 x 18 cm 50/1000



Personal
268



.01



.32

29072 *denni*

Supporto | Holder | Soporte | Porte TV control de table
Plastica | Plastic | Plástico | Plastique

8 x 6,5 x 5,5 cm T7 3,5 x 1,5 cm 50/100



.32

29075 *andres*

Supporto e portapenna con pinza porta memo | Pen holder with memo clip | Soporte y porta boligrafo con pinza portanotas | Suport et porte stylo avec pince porte mémo
Plastica | Plastic | Plástico | Plastique

7,7 x 9,3 x 6,5 cm T7 | UV17 3 x 1 cm 50/100



.23



41775 *jannu*

Portacellulare con collarino | Mobile phone holder | Funda móvil | Collier porte-téléphone portable
Poliestere | Polyester | Poliëster | Polyester

13,5 x 7,5 cm S8 | SP34 (only on white color) 5 x 3 cm

50/1000



.04



.01

.08

.23

.07

41089 *adur*

Borsello con uscita per auricolari | Mobile phone bag with earphones output | Bolso portaobjetos con salida auriculares | Sac avec sortie pour écouteurs
Neoprene | Neopreno | Neopreno | Néoprène

14 x 1 x 9 cm S8 3 x 2 cm 50/200

Personal
269



.01



.05 .17 .07 .06 .08



.08



.01 .02 .04 .03 .17 .07 .06 .23

40229 *lermontov*

Porta carte di credito | Credit card holder | Tarjetero | Porte cartes de crédit
Similpelle | Imitation Leather | Semipièl | Similicuir

10,8 x 7,5 cm S95 3 x 3 cm 250

41065 *camelia*

Porta carte con 1 scomparto | Credit card holder 1 compartment | Tarjetero 1
compartimento | Porte-Cartes avec 1 compartiment
PVC

9,5 x 6,5 x 0,1 cm 5000



85085 *grisignano*

Rilevatore banconote false con luce ultravioletta | Counterfeit Note
Detector with ultraviolet light | Detector de billetes falsos con luz
ultravioleta | Détecteur de faux billets avec lampe UV
Alluminio | Aluminium | Aluminio | Aluminium

7,9 x 2,5 x 1,2 cm T7 | L22 3 x 1 cm 1/500



41026 *blan*

Portacarta di credito | Credit card holder for one card | Funda para
una tarjeta de crédito | Porte carte pour une carte
Plastica | Plastic | Plástico | Plastique

6 x 9 x 0,4 cm T6 2 x 0,8 cm 200/1000



.02



.08

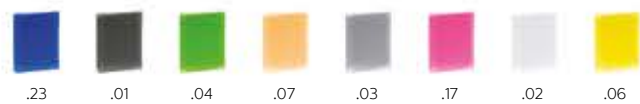

.23 .01 .04 .07 .03 .17 .02 .06



.08

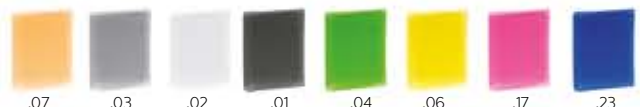

.07 .03 .02 .01 .04 .06 .17 .23

41070 *ecolo*

Porta carte 6 scomparti | Credit card holder with 6 compartments | Tarjetero
con 6 compartimentos | Porte-Cartes avec 6 compartiments
PVC

7,5 x 10,3 x 0,4 cm 1000

41067 *empire*

Porta carte con 2 scomparti | Credit card holder with 2 compartments |
Tarjetero con 2 compartimentos | Porte-Cartes avec 2 compartiments
PVC

6,5 x 9,5 x 0,2 cm 2000



.05



.02 .08 .06

60087 *mango*

Porta carte con portafoglio | Wallet with Credit Card Holder | Tarjetero
| Porte-Cartes avec portefeuille
Similpelle | PU | Polipièl | Similicuir

10,8 x 7,7 x 0,5 cm L7 2 x 1 cm 500



.06



.08 .01 .11 .05

41358 *convolvolo*

Porta carte di credito | Credit card holder | Tarjetero y monedero
Porte cartes de crédit
PU

10,3 x 7,4 x 0,6 cm S2 4 x 2 cm 50/500



RFID
PROTECTED

26380 *colza*

Porta carte di credito | Credit card holder | Tarjetero y monedero | Porte cartes de crédit
PU

8,2 x 11,7 x 1,5 cm S96 | L7 3 x 3 cm 200



41093 *kira*

Portamonete tacco | Coin purse | purse and frame-up closing | Monedero | Portemonnaie avec fermeture
Pelle | Leather | Piel | Cuir

8 x 7 x 1,3 cm S2 3 x 2 cm 50/500

41046 *puna*

Portamonete tacco | Coin purse | purse and frame-up closing | Monedero | Portemonnaie avec fermeture
Microfibra | Microfiber | Microfibra | Microfibre

8 x 7 x 1,3 cm S2 3 x 2 cm 50/250



40147 *ghislarengo*

Porta carte di credito | Credit card holder | Tarjetero y monedero | Porte cartes de crédit
Alluminio | Aluminium | Alluminio | Aluminium

8,9 x 5,8 x 0,7 cm T7 | L7 2 x 0,8 cm 400



42060 *emlopp*

Porta monete in canvas con tira zip in PU | Purse in canvas with PU zip puller | Monedero de canvas con tirador de PU | Porte monnaie en canvas avec accroche fermeture éclair en PU
Cotone 220gr, PU | Cotton 220gr, PU | Algodón 220gr, PU | Coton 220gr, PU

11 x 2,5 x 9 cm S8 6 x 4 cm 400



47023 *mimo*

Portamonete con portachiavi | Purse with keyring | Monedero con llavero | Portemonnaie avec porteclés
Pelle | Leather | Piel | Cuir

10 x 6 x 1 cm S8 2 x 1 cm 50/500



RFID
PROTECTED



41356 *vaiaku*

Porta carte di credito | Credit card holder | Tarjetero y monedero | Porte cartes de crédit
Plastica | Plastic | Plástico | Plastique

12 x 6 x 0,4 cm T6 2 x 0,8 cm 1000



41064 *birger*

Portafoglio | Wallet | Cartera | Portefeuille
Poliestere 300D | Polyester 300D | Poliéster 300D | Polyester 300D

7,7 x 12,6 x 1 cm S8 3 x 1 cm 10/400





41116 **azov**

Portachiavi/portafoglio | Keyring and wallet | Llavero y cartera | Portecclés et portefeuille
Nylon 70d

7,7 x 12,6 x 1 cm S8 3 x 1 cm 50/250



41117 **carum**

Mini portachiavi | Mini keyring | Mini llavero | Mini portecclés
Nylon 70d

4,5 x 8 cm S8 2 x 1 cm 50/300



41125 **gamberale**

Portachiavi a borsetina | Handbag shaped keyring | Llavero forma bolso | Porte-clé avec pochette
Nylon 70d

10 x 5,5 cm S8 2 x 1 cm 50/500



41118 **castanea**

Portafoglio | Wallet | Cartera | Portefeuille
Nylon 70d

S8 3 x 1 cm 50/200



intagande

eklog

mechander



41778 **eklog**

Portamonete con tasca esterna | Coin purse with pocket | Monedero con cremallera exterior | Porte monnaie avec poche interne
50% cotone 50% poliestere | 50% cotton 50% polyester | 50% algodón 50% poliéster | 50% coton 50% polyester

12 x 9,5 x 1 cm S8



43143 **intagande**

Portamonete | Purse | Monedero | Porte monnaie PVC

11 x 14 x 3,5 cm S8 1400



45005 **mechander**

Pochette multiuso con moschettone | Purse with carabin | Monedero con mosqueton | Sacoche porte-tout avec avec mousqueton
Poliestere | Polyester | Poliéster | Poliéster

S8 2 x 2 cm 50/500



.01



.31

.32

43125 *genova*

Borsello metallizzato con cerniera | Metallic pocket with zip | Bolso con cremallera | Sacoche gris métallisé fermeture éclair
Similpelle | PU | Polipiel | Simili-cuir

12 x 8 cm S8 3 x 2 cm 10/200



.23



.08

.11

.07

.01

.08

41778 *ölüdeniz*

Portamonete con 2 cerniere | Purse with 2 zips | Monedero con 2 cremalleras | Porte monnaie avec 2 zip
PVC | PVC | PVC | PVC

10,5 x 9 cm L10 6 x 2 cm 500



.06



.08

.02

.17

.23

.07

41106 *dafne*

Portamonete | Purse | Monedero | Porte Monnaie
Silicone | Silicone | Silicona | Silicone

9,5 x 9 x 4,5 cm S94 5 x 3 cm 300



.09

41124 *bor*

Portamonete zainetto con anello portachiavi | Purse with keyring | Monedero con llavero | Portemonnaie en forme de sac à dos avec anneau portecclés
Nylon 70D

6 x 7,5 x 2 cm S8 1,5 x 1,5 cm 100/500



.32



.02



.08



.18

.17

.19

41104 *uffe*

Portamoneta con cerniera | Purse with zip | Monedero con cremallera | Portemonnaie avec charnière
Similpelle | Imitation Leather | Imitacion lider | Similicuir

10,5 x 7,5 x 2 cm S8 5 x 2 cm 20/1000



.04

.06

.08

41075 *multia*

Portamonete | Coin purse | Monedero | Portemonnaie
Similpelle | Imitation leather | Polipiel | Similicuir

17 x 11 x 2 cm S8 4 x 2 cm 200



.04

.06

41040 *hele*

Portamonete click-clack | Click-clack purse | Monedero click-clack | Portemonnaie clic-clac
Nylon 70D

9 x 7 cm S2 4 x 2 cm 50/500



.08



.01

.07

47017 *olma*

Portamonete con portachiavi | Purse with keyring | Monedero con llavero | Portemonnaie avec portecclés
Similpelle | Imitation Leather | Polipiel | Similicuir

10 x 6,5 cm S8 2 x 1 cm 50/500



.08



.17

.02

.01

.04

.06

.05

.03

41113 *kirat*

Custodia | Pouch | Funda | Etui (Accessories excl.)
Similpelle | Imitation leather | Polipiel | Similicuir

3,7 x Ø 7 cm S2 Ø 4 cm 100/500



.04



.05

.06

.08

41045 *runa*

Portamonete con portachiavi | Purse with keyring | Monedero con llavero | Portemonnaie avec portecclés
Nylon 70D

Ø 8 cm S8 Ø 3 cm 100/1000



47066 *texy*

Portachiavi | Keyring | Llaveró | Portclés
EVA

8 x 3,3 x 2,3 cm T11 2 x 1,5 cm 20/1000



47071 *tivi*

Portachiavi | Keyring | Llaveró | Portclés
PVC

8,5 x 6,5 x 0,5 cm T11 2,5 x 1 cm 50/1000



45008 *duena*

Portachiavi con inserto colorato | Trasparent keyring | Llaveró transparente |
Portclé avec cercle coloré
Plastica | Plastic | Plástico | Plastique

8 x 3,5 x 0,5 cm T11 2 x 1 cm 50/250



47202 *godiasco*

Portachiavi a casco di sicurezza. | Keyring | Llaveró | Portclé en forme de
casque de sécurité.

Plastica | Plastic | Plástico | Plastique

3,7 x 3,8 x 2,2 cm T11 1,5 x 1,5 cm 50/400



49047 *vera*

Portachiavi galleggiante | Floating keyring | Llaveró flotante | Portclés flottant
EVA

6,8 x 3,3 x 1,4 cm T11 3 x 1 cm 50/1000



45010 *seza*

Portachiavi galleggiante ad infradito | Floating flip-flop keyring | Llaveró flotante |
Portclés flottant
EVA

3 x 6,5 x 0,9 cm T11 3 x 1 cm 100/500



48016 *nabo*

Salvietta per occhiali personalizzabile in quadricromia | Cleaning cloth for glasses
ideal for sublimation printing | Toallita limpia gafas por logotipo en quadricromia |
Serviette pour lunettes idéal pour le marquage en sublimation
Microfibra | Microfiber | Microfibra | Microfibre

13 x 18 cm SP12 13 x 18 cm 100/1000

47645 *hooter*

Portachiavi con salvietta per occhiali | Keyring with cleaning cloth for
glasses | Llaveró con toallita limpia gafas | Portclés avec serviette pour
lunette

Plastica soft | Soft plastic | Plástico blando | Plastique soft

Ø 6 x 1,5 cm T6 3 x 2 cm SP13 13 x 18 cm 50/200



47005 *effi*

Portachiave porta accendino con clip | Lighter holder with keyring and clip | Llavero con porta mechero | Porteclés avec porte briquet et clip
Plastica, metallo | Plastic, metal | Plástico, metal | Plastique, métal

9 x 3 x 1,5 cm T11 2,5 x 0,7 cm 50/500



49983 *enix*

Portachiavi | Keyring | Llavero | Porte-Clés
Alluminio | Aluminium | Alluminio | Aluminium

2,9 x 5,4 x 0,1 cm T4 | L5 3 x 2 cm 1000

KEY *ring*



47133 *lima*

Portachiavi trasparente portafoto/logo | Translucent keyring with photoframe | Llavero translúcido para insertar papel impreso o foto | Porte-clés transparent avec portephoto
Plastica | Plastic | Plástico | Plastique

2,5 x 4,1 cm T11 | D8 2 x 3 cm 100/1000



46139 *smolensk*

Portachiavi in legno | Wooden keyring | Wooden keyring | Porteclés en bois
Legno | Wood | Madera | Bois

3,3 x 5,3 cm T4 | L5 2 x 3 cm 250



46137 *rybachiy*

Portachiavi tappo di sughero | Keyring | Keyring | Porteclés bouchon en liège
Sughero | Cork | corcho | liège

∅ 2,3 x 4,5 cm T4 | L5 3 x 1 cm 250



.04



.18 .02 .05 .06 .01 .08 .23 .07

47092 *insbruck*

Portachiavi con moschettone | Keyring with carabiner | Llavero con mosquetón | Porte-clés avec mousqueton

Poliestere, metallo | Polyester, metal | Poliéster, metal | Polyester, métal

9 x 2 cm S2 3 x 1 cm 10/500



.05



.07 .06 .08 .04

47143 *aventurine*

Portachiavi con forma di poker fiches | Poker fiches keyring | Llavero con forme de poker fiches | Porte-clés a poker fiches

Plastica | Plastic | Plástico | Plastique

Ø 4,2 cm ca T11 1 x 1 cm 50/1000



.08



.05

.01

.06

47040 *eryk*

Portachiavi con moschettone | Carabiner with keyring | Llavero con mosqueton | Porteclés avec mosqueton

Alluminio | Aluminium | Aluminio | Aluminium

5,6 x 3 x 0,5 cm L5 2 x 0,5 cm

100/1000



.05

.01



.08

.01

.02

.05

46118 *ialea*

Supporto iPhone con altoparlante e portachiavi. | Mobile phone support keyring and speaker | Llavero soporte para el móvil y altavoz | Porte Iphone avec porte-clés et haut-parleur

Plastica e silicone | Plastic and silicone | Plástico y siliconci | Plastique et silicone

6,3 x 2,7 x 2,7 cm T11 | UV1 3 x 1 cm 50/500



.02

.08

.05

.01

46119 *hidra*

Porta cellulare e portachiavi con puliscschermo. | Mobile phone support keyring and screen cleaner | Llavero soporte para el móvil y limpiador de pantalla | Porte téléphone portable porte-clés avec nettoyeur d'tactile.

Plastica | Plastic | Plástico | Plastique

2 x 7,3 x 1,8 cm T11 | UV1 4 x 1 cm 100/1000

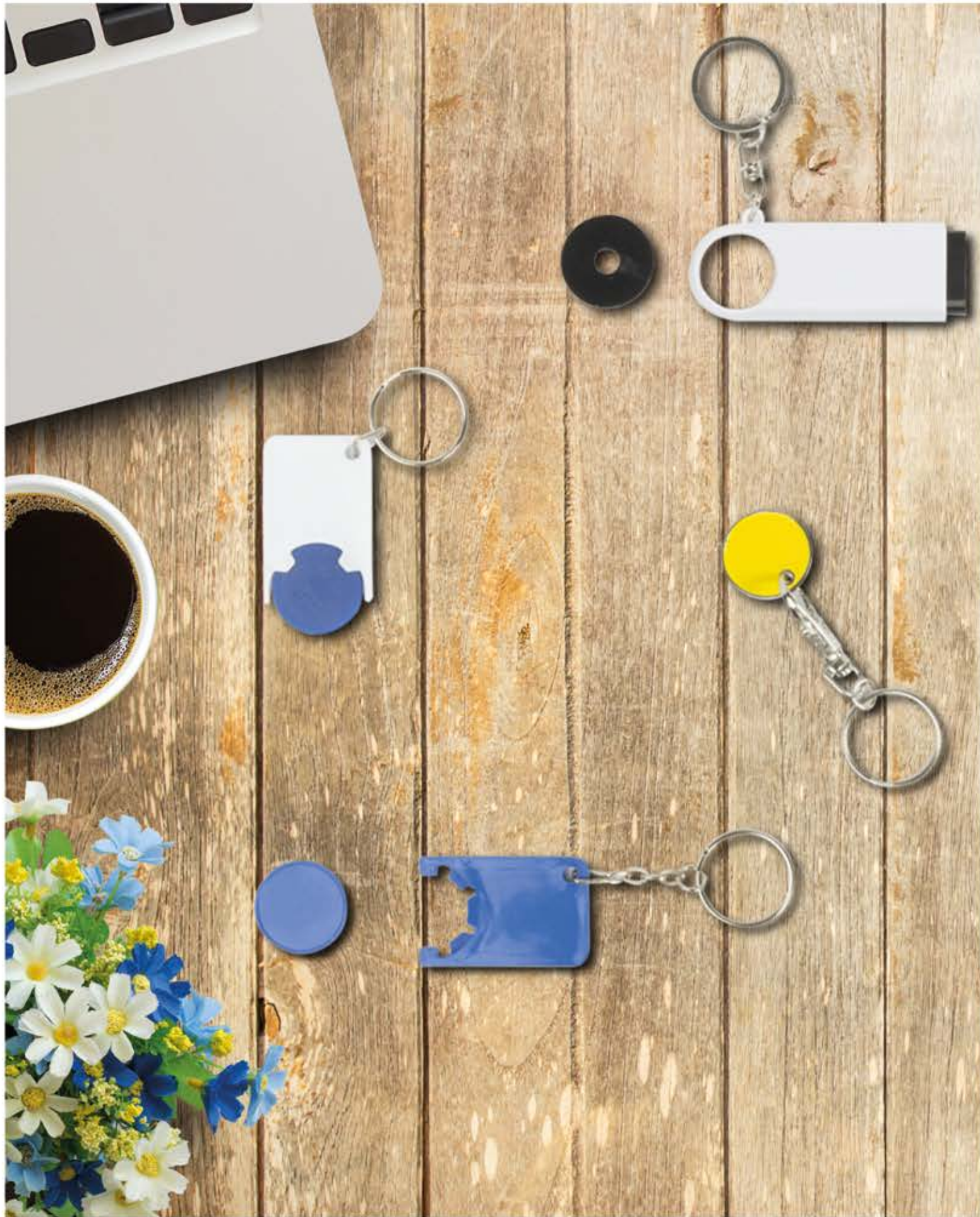

47059 *paccu*

Portachivi con gettone per carrello | Keyring with shopping trolley coin | Llavero con moneda para el carrito de la compra | Portecclés avec jeton pour chariot
Metallo | Metal | Metal | Métal

☞ Ø 2 cm ☞ T4 | L5 Ø 1,5 cm ☞ 100/1000



47081 *flor*

Gettone per carrello | Shopping trolley coin | Moneda para el carrito de la compra | Jeton pour chariot
Plastica | Plastic | Plástico | Plastique

☞ 6 X 3,4 X 0,4 cm ☞ T1 Ø 2,5 cm ☞ 500/4000



47125 *aube*

Portachivi con luce e gettone per carrello | Keyring wit LED and coin | Llavero con LED y moneda | Porte-cles avec lumiere et porte-jeton
Plastica | Plastic | Plástico | Plastique

☞ 7 x 1 x 2,5 cm ☞ T11 2 x 1 cm ☞ 100/1000





.05 .08 .02 .01 .04 .06 .17

47131 *parnaya*

Portachiavi con gettone per carrello | Shopping trolley coin keyring | Llavero por moneda para el carrito de la compra | Portecclés avec jeton pour chariot
Plastica | Plastic | Plástico | Plastique

2,8 x 5,1 x 0,4 cm T11 UV1 2 x 1,2 cm 100/1000



.07

47655 *färgrik*

Portachiavi con gettone per carrello | Shopping trolley coin keyring | Llavero con ficha para el carrito de la compra | Portecclés avec jeton pour chariot
ABS | ABS | ABS | ABS

3,5 x 5 x 0,8 cm T11



.01 .04 .05 .17 .06 .08



.08



.04



.06 .17 .02 .07 .08 .05 .01

47039 *caela*

Portachiavi per gettone per carrello | Shopping trolley coin keyring | Llavero por moneda para el carrito de la compra | Portecclés avec jeton pour chariot
Plastica | Plastic | Plástico | Plastique

2,9 x 5,7 x 0,4 cm T11 UV1 2 x 1,2 cm 100/1000



47653 *volex*

Portachiavi torcia con luce bianca | keyring with flashlight LED | Llavero linterna | Portecclés avec lampe
Plastica, metallo | Plastic, metal | Plástico, metal | Plastique, métal

7,5 x 3,5 cm T11 2 x 0,07 cm 1000



.08 .32
.01 .05



.04



.05 .01 .08

47656 *macarelleta*

Torcia a 3 luci LED con portachiavi. Batteria inclusa | Torch with 3 LED lights and keyring. Battery included | Linterna de 3 luces LED con llavero. Pila incluida | Torche 3 LED avec portecclés. Batterie incluse
Alluminio | Aluminium | Aluminio | Alluminium

1,8 x 5,5 cm T6 2,5 x 0,9 cm 200



.19 .08 .07 .05

47020 *volma*

Portachiavi con luce led, batteria inclusa | Keyring with light led, including battery | Llavero con luz led, pila incluida | Portecclés avec lumière led, pile incluse

Plastica | Plastic | Plástico | Plastique

10 x 2,5 x 0,5 cm T11 UV1 3 x 1 cm 100/1000



.32



46140 *calendula*

Portachiavi | Keyring | Llavero | Portecclés
 Alluminio | Aluminium | Aluminio | Alluminium
 4 x 2,2 x 0,2 cm T4 | L5 2 x 1 cm 50/300



47647 *achior*

Portachiavi | Keyring | Llavero | Portecclés
 Metallo | Metal | Metal | Métal
 3,6 x 3,4 x 0,2 cm T4 | L5 Ø 1 cm 100/1000



47029 *zenta*

Portachiavi "casetta" | Keyring "home" | Llavero "casita" | Portecclés "maisonnette"
 Metallo | Metal | Metal | Métal
 3,8 x 3,5 x 0,2 cm T4 | L5 1,5 x 1,5 cm 100/1000



47062 *rena*

Portachiavi "macchina" | Keyring "car" | Llavero "coche" | Portecclés "voiture"
 Metallo | Metal | Metal | Métal
 4,5 x 3,6 x 0,2 cm T4 | L5 3 x 1 cm 100/1000



46059 *roda*

Portachiavi, possibilità di personalizzazione resinata | Keyring, resin customization possibility | Llavero, posibilidad de personalización de resina | Portecclés avec possibilité de personnalisation en doming
 Metallo | Metal | Metal | Métal
 3,5 x 9,5 cm L2 | D7 Ø 2,5 cm 50/200



46055 *dudo*

Portachiavi | Keyring | Llavero | Portecclés
 Metallo | Metal | Metal | Métal
 2,5 x 8,5 x 0,3 cm L2 2,5 x 1 cm 50/200



46029 *gesa*

Portachiavi "camiòn" | Keyring "truck" | Llavero deluxe "camiòn" | Portecclés "camiòn"
 Metallo | Metal | Metal | Métal
 7,5 x 2,9 x 0,3 cm L2 2 x 0,8 cm 50/400



46512 *similan*

Portachiavi "camiòn" | Keyring "truck" | Llavero deluxe "camiòn" | Portecclés "camiòn"
 Metallo | Metal | Metal | Métal
 5 x 3,5 cm L2 2,5 x 1 cm 200



49985 *ippo*

Portachiavi | Keyring | Llavoro | Porte-Clé |
Metallo | Metal | Metal | Métal

2,2 x 5,4 x 0,7 cm T4 | L5 2 x 1 cm 500

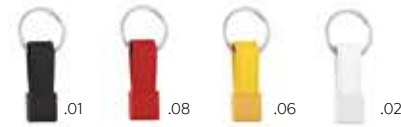

46086 *oco*

Portachiavi | Keyring | Llavoro | Portecclés
Similpelle, metallo | Metal, Imitation leather | Polipiel, metal | Similicuir, métal

2 x 5,8 x 0,6 cm T4 | L5 1 x 1 cm 500



46061 *mali*

Portachiavi | Keyring | Llavoro | Porte clés
Similpelle | Imitation leather | Polipiel | Similicuir

3,8 x 5,5 x 0,7 cm T11 3 x 1 cm 100/1000



46021 *tare*

Portachiavi | Rotating keyring | Llavoro | Porteclés
Metallo | Metal | Metal | Métal

3,8 x 5,5 x 0,4 cm L2 | D7 Ø 1,5 cm 50/200

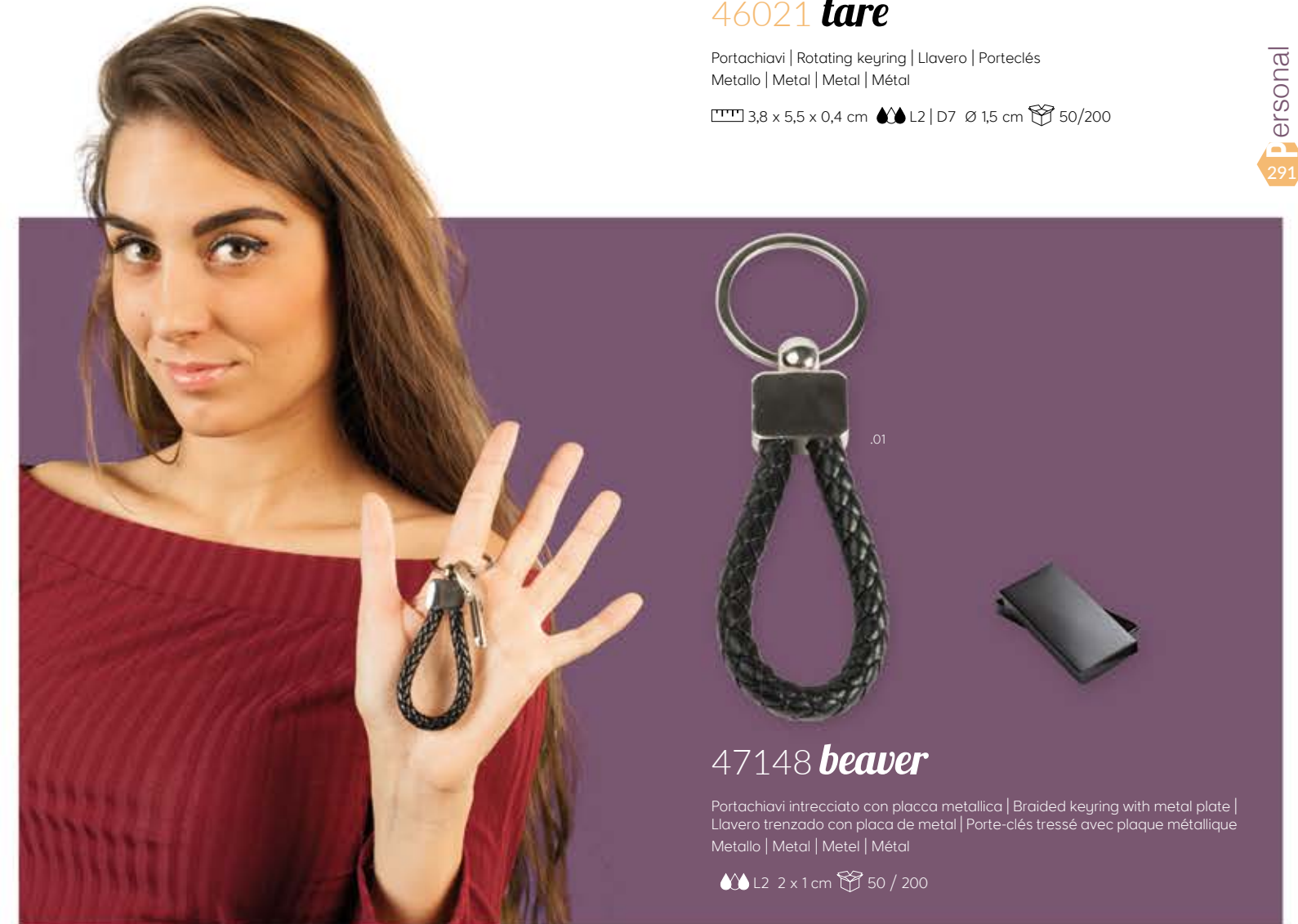

47148 *beaver*

Portachiavi intrecciato con placca metallica | Braided keyring with metal plate |
Llavoro trenzado con placa de metal | Porte-clés tressé avec plaque métallique
Metallo | Metal | Metal | Métal

L2 2 x 1 cm 50 / 200



tami



46030 tami

Portachiavi, placca metallica e nastro colorato | Keyring | Llavero con tira de nylon y placa de metal | Portecclés, plaque métallique et bande coloré
Metallo | Metal | Metal | Métal

6 x 3 x 0,5 cm L2 | T4 2,5 x 1,5 cm 50/200



46007 temme

Portachiavi con placca metallica e nastro colorato | Keyring supplied in gift box | Llavero con placa y cordón de color | Portecclés avec plaque métallique et bande colorée
Metallo | Metal | Metal | Métal

6 x 2,5 x 0,5 cm L2 | T4 2 x 1 cm 50/200

46020 raba

Portachiavi | Keyring | Llavero | Portecclés
Metallo | Metal | Metal | Métal

3,5 x 6,5 x 0,5 cm L2 | D7 Ø 1,7 cm 50/200



46018 leri

Portachiavi multi-anelli | Multi keyring | Llavero multi-anillos | Portecclés multi aneaux
Metallo | Metal | Metal | Métal

3 x 1 x 5,6 cm L2 | D7 Ø 2,5 cm 50/200



.06 .08 .23 .01 .02

46015 *fip*

Portachiavi "macchina" con astuccio | Keyring "car" with gift box | Llavoro "coche" con caja regalo | Portecclés "voiture" avec boîte cadeau
Metallo | Metal | Metal | Métal

4,3 x 6 x 0,5 cm L2 2 x 0,5 cm 50/200



.32

Personal
294

47654 *enudden*

Portachiavi | Keyring | Llavoro | Portecclés
Metallo, PU | Metal, PU | Metal, PU | Métal, PU

2,5 X 8 X 1 cm L5



.08

.01

.05

46124 *honolulu*

Portachiavi | Keyring | Llavoro | Porte-clés
Similpelle, metallo | Imitation leather, metal | Polipiel, metal | Similcui, métal

1,8 x 9 x 0,7 cm L2 1 x 1 cm 50/400



.01



46513 *palolem*

Portachiavi in astuccio regalo | Keyring with gift box | Llavoro con estuche regalo | Portecclés avec boîte cadeau
Metallo, PU | Metal, PU | Metal, PU | PU, métal, carton

2,5 x 6,5 cm S32 1,7 x 1,7 cm 200



.01

47006 *simi*

Portachiavi | Keyring | Llavoro | Portecclés
Metallo, similpelle | Metal, Imitation leather | Metal, polipiel | Métal, simil-cuir

7 x 9,6 x 2,6 cm L2 2 x 1 cm 50/250

47149 *huapi*

Portachiavi con particolari in alluminio | Keyring with aluminum finishing | Llavoro con detalles de aluminio | Porte-clés avec détails en aluminium
Pelle, alluminio | Leather, aluminium | Piel, aluminium | Cuir, aluminium

L2 1 x 1 cm 50 / 200



.01

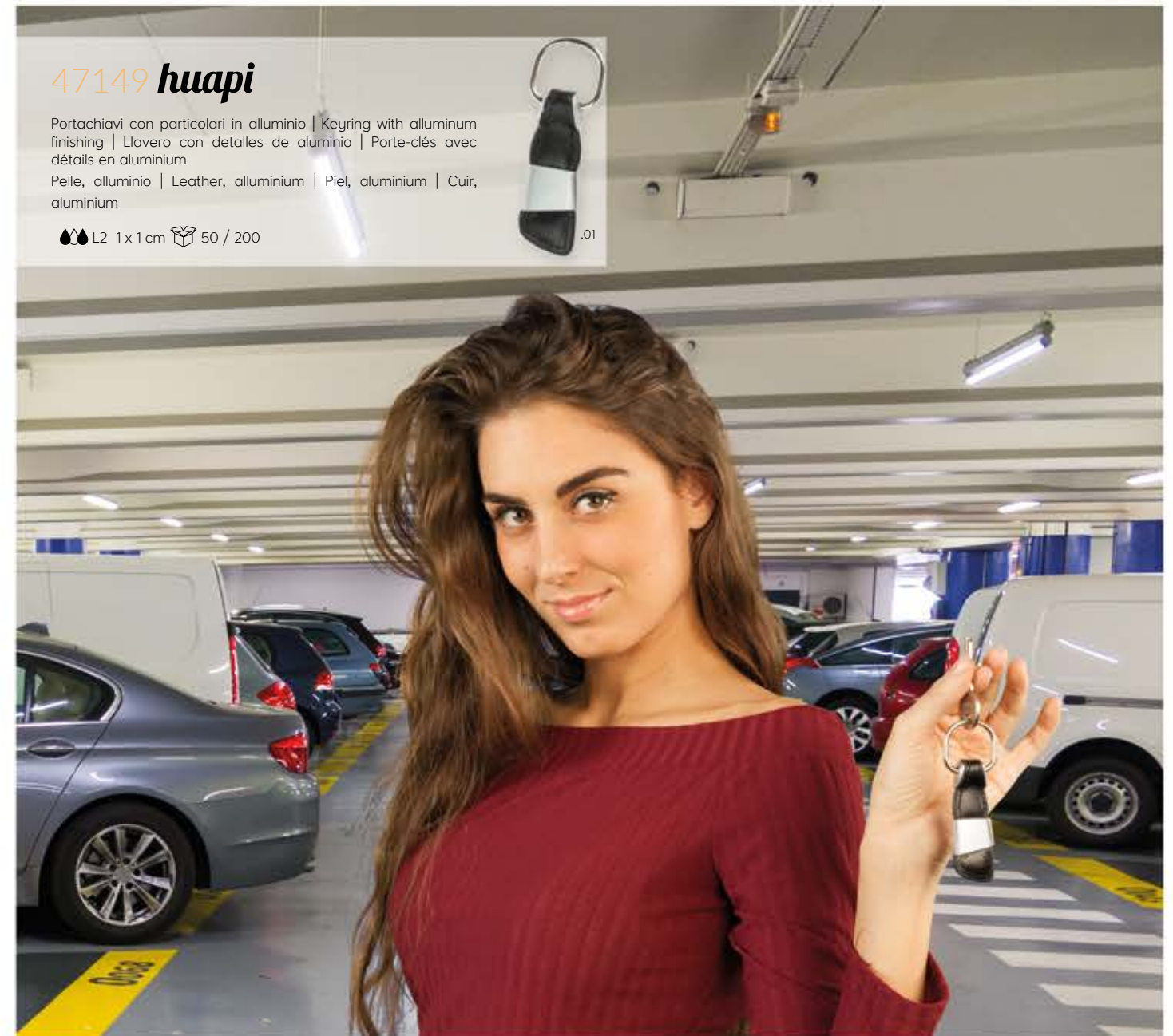

Personal
295



46127 *lipet*

Portachiavi confezionato in polybag singolo con cardboard sul retro | Keyring | Llavoro | Portaclés
Alluminio | Aluminium | Aluminio | Aluminium

2,5 x 1 x 2,8 cm L2 1 x 1 cm 50/200



47657 *bonita*

Portachiavi casetta in astuccio regalo | Keyring shaped as a house with gift box | Llavoro en forma de casita con estuche regalo | Portaclés maison avec boîte cadeau
Alluminio | Aluminium | Aluminio | Aluminium

3,5 x 1 x 2,5 cm S3 2 x 0,8 cm 200



46138 *rossiyskiy*

Portachiavi | Keyring | Keyring | Portaclés
Metallo | Metal | Metal | Métal

3 x 4,5 cm L2 1,5 x 0,8 cm 250



47091 *genuri*

Portachiavi | Keyring | Llavoro | Porte-clés
Metallo | Metal | Métal | Métal

∅ 2,5 cm L2 1 x 1 cm 50/200



45017 *arun*

Portachiavi confezionato in polybag singolo con cardboard sul retro | Car shaped keyring | Llavoro con forma coche | Porte-clés voiture
Alluminio | Aluminium | Aluminio | Aluminium

2 x 1 x 4 cm L2 2 x 1 cm 50/400



46142 *cirmolo*

Portachiavi con confezione | Keyring with box | Llavoro con caja | Portaclés avec boîte
Alluminio | Aluminium | Aluminio | Aluminium

3,5 x 2,5 x 1 cm T4 | L5 2 x 0,8 cm 50/200



29062 kale

Maggiolino antistress | Anti stress car | Coche anti-estrés | Voiture antistress
Gommapiuma | Foam rubber | Gomaespuma | Caoutchou

📏 9,5 x 5,5 x 5,2 cm 💧 T6 2 x 2 cm 📦 50/250

29228 praia

Antistress Nave | Boat anti-stress | Barco antiestrés | Bateau anti-stress
Gommapiuma | Foam rubber | Gomaespuma | Caoutchou

💧 T6 2 x 1 cm 📦 50/200

29068 ria

Aeroplano antistress | Anti stress plane | Avión antiestrés | Avion antistress
Gommapiuma | Foam rubber | Gomaespuma | Caoutchou

📏 10 x 9 x 4,5 cm 💧 T6 3 x 1 cm 📦 50/250



29137 arda

Portachiavi con pallina antistress | Keyring with anti stress ball | Llavero con bola antiestrés | Portecclés avec boule antistress
Gommapiuma | Foam rubber | Gomaespuma | Caoutchou

📏 Ø 4 cm 💧 T11 Ø 1,5 cm 📦 20/1000

29056 elsa

Portachiavi antistress | Anti stress keyring | Llavero antiestrés | Portecclés antistress
Gommapiuma | Foam rubber | Gomaespuma | Caoutchou

📏 3,5 x 8,2 x 1,9 cm 💧 T6 | UV19 4 x 1,5 cm 📦 100/1000



47204 gadesco

Portachiavi antistress a forma di lampadina. | Keyring with anti-stress. | Llavero antiestrés | Portecclés antistress en forme d'ampoule
Gommapiuma | Foam rubber | Espuma de caucho | Eponge

📏 6,7 x 3,5 cm 💧 T11 Ø 1,5 cm 📦 20/1000

29206 Kiev

Portachiavi frutta antistress | Antistress Fruit Keyring | Llavero frutal antiestrés | Porte-Clés antistress en forme de fruits
Gommapiuma | Foam rubber | Gomaespuma | Caoutchou

💧 T11 Ø 1 cm 📦 10/100



47201 jackson

Portachiavi antistress | Antistress keyring | Llavero antiestrés | Antistress PU

📏 Ø 4 cm 💧 T11 Ø 1,5 cm 📦 200/800



29235 budapest

Antistress a forma di casetta | House shaped anti stress | Casa anti estrés | Antistress maison
Gommapiuma | Foam rubber | Gomaespuma | Caoutchou

📏 7 x 8 x 7 cm 💧 T6 3 x 2 cm 📦 50/200



.18

.08



.08

.23



.08



.02



.02

29151 *tede*

Goccia antistress | Anti stress drop | Gota antiestrés | Jouet antistress en forme de goutte d'eau | Gommapiuma | Foam rubber | Gomaespuma | Caoutchouc

6,5 x 11 cm T6 Ø 2 cm 50/200

29998 *kungsholmen*

Antistress a forma di goccia | Antistress shaped as a drop | Antiestrés con forma de gota | Antistress en forme de goutte | Gommapiuma | Foam rubber | Gomaespuma | Caoutchouc

8 x Ø 6 cm T6 Ø 2 cm 400

29063 *lovi*

Cuore antistress | Anti stress heart | Corazón antiestrés | Coeur antistress | Gommapiuma | Foam rubber | Gomaespuma | Caoutchouc

7 x 6,7 x 5,4 cm T6 Ø 2,5 cm

50/250

29253 *punaka*

Antistress "nuvoletta" | Anti-stress | Antiestrés | Antistress en forme de nuage. | Gommapiuma | Foam rubber | Espuma de caucho | Caoutchouc

10 x 5,6 x 2 cm T6 6 x 3 cm 50/200

29241 *celosia*

Anti-stress | Anti-stress | Antiestrés | Anti-stress | Gommapiuma | Foam rubber | Gomaespuma | Caoutchouc

9 x 5,8 x 5,8 cm T6 2 x 2 cm 50/200

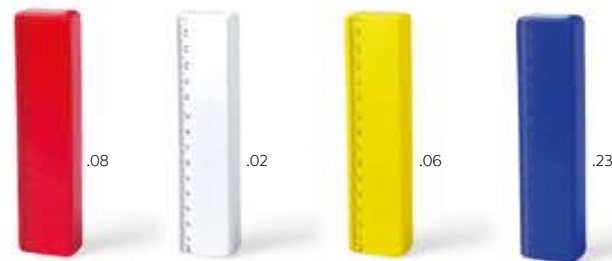

.08

.02

.06

.23



29258 *espejo*

Antistress righello | Antistress ruler | Antistress | Antistress | Gommapiuma | Foam rubber | Gomaespuma | Caoutchouc

15,2 x 1,8 x 3,7 cm T6 10 x 2 cm 50 / 300



.02

29060 *deme*

Antistress "dottoress" | Anti stress doctor | Anti-estrés "doctor" | Antistress "docteur" | Gommapiuma | Foam rubber | Gomaespuma | Caoutchouc

5 x 9,5 x 3,5 cm T6 3 x 1 cm 50/250





.00



.02



.08



.01

.02

.06

.23

29057 *hami*

Dado antistress | Antistress dice | Dado antiestrés | Dé antistress
Gommapiuma | Foam rubber | Gomaespuma | Caoutchou

5,5 x 5,5 x 5,5 cm T6 1 x 1 cm

50/200

29186 *carrubo*

Antistress lampadina | Antistress | Antiestrés | Antistress en forme d'ampoule
Gommapiuma | Pu | Gomaespuma | Caoutchouc mousse

10 x Ø 6 cm T6 Ø 2 cm 50/250

29184 *venere*

Antistress cubo | Antistress | Antiestrés | Antistress en forme de cube
Gommapiuma | Foam rubber | Gomaespuma | Caoutchouc

4,4 x 4,4 x 4,4 cm T6 | UV19 3 x 3 cm

50/250



.40

29038 *enri*

Antistress a forma di pallone | Football shaped antistress | Antiestrés en forma de bola | Antistress en forme de ballon
Gommapiuma | Foam rubber | Gomaespuma | Caoutchouc

Ø 6,3 cm T6 Ø 1 cm 50/200



.04

.07

.17

.08

.01

.02

.06



.23

29054 *frek*

Pallina antistress | Antistress ball | Pelota antiestrés | boules antistress
Gommapiuma | Foam rubber | Gomaespuma | Caoutchouc

Ø 6,2 cm T6 Ø 2,5 cm 50/200

always ready
for any
eventuality...



Personal
304



48018 *imme*

Kit primo soccorso, 13 accessori | First aid kit, 13 accessories | Kit emergencia, 13 accesorios | Kit urgences, 13 accessoires
Poliestere 600D | Polyester 600D | Poliéster 600D | Polyester 600D

8,8 x 11,5 x 5 cm S93 | TR2 4 x 3 cm 1/300 cm

48023 *isaac*

Set primo aiuto da 36 accessori | First aid set. | Set de primeros auxilios | Kit premier secours 36 accessoires
Plastica | Plastic | Plástico | Plastique

9,5 x 13 x 3 cm T6 | UV9 5 x 3 cm 1/200



48006 *idar*

Porta cerotti 5 pz | Plaster holder, 5 pcs | Estuche porta tiritas (5 pzs) | Étui porte sparadrap (5 pcs)
Plastica | Plastic | Plástico | Plastique

4,1 x 10,2 x 1 cm T6 | UV2 4 x 1,5 cm 100/600

MEDICAL accessory



20006 *farma*

Penna | Toth paste pen | Boligrafo | Stylo
Plastica | Plastic | Plástico | Plastique

12 cm Ø 1,8 cm T2 3 x 1 cm 100/1000



20134 *ahind*

Penna a sfera con la torcia elettrica a LED. Pila a bottone inclusa | Ballpoint pen with LED flashlight. Button cell included | Boligrafo con linterna LED. Pila botón incluida | Stylo à bille avec lampe de poche LED. Pile incluse
Plastica | Plastic | Plástico | Plastique

14 x Ø 1,4 cm T2 4 x 0,7 cm 25/500

Personal
305

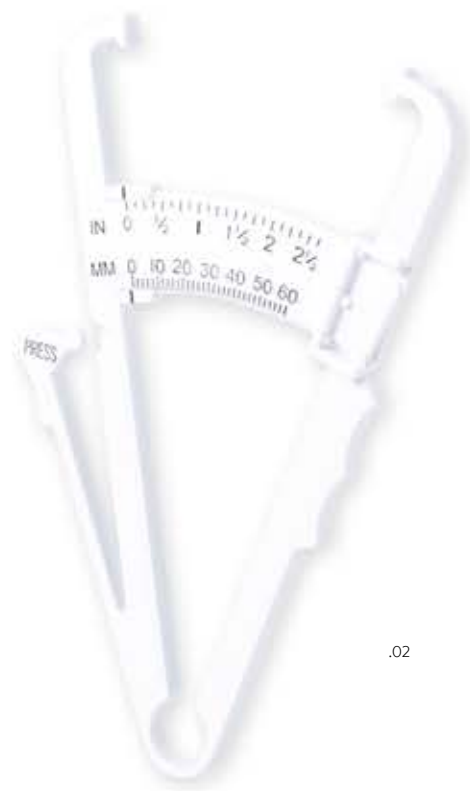

.02

82049 *gaeta*

Pinza misura massa grassa | Body fat ruler | Medidor de grasa corporal
| Pince mesure graisse
Plastica | Plastic | Plástico | Plastique

16,3 x 9,7 x 0,7 cm T7 2 x 0,6 cm 50/200



.02

35007 *bruce*

Orologio da medico con clip e catena in metallo | Doctor clock with metal
chain and clip | Reloj para médico con cadena y clip de metal | Montre
docteur avec chaîne et clip en métal
Metallo | Metal | Metal | Métal

3 x 9 x 2 cm T7 1 x 0,5 cm 50/400



.02

61025 *volko*

Clip con calcolatrice | Clip board with calculator | Calculadora
pinza | Ecrtoire avec clip et calculette
Plastica | Plastic | Plástico | Plastique

21,5 x 3 x 33,5 cm T8 5 x 5 cm 10/40



.02

48207 *trussinis*

Misure di massa corporea | Body Mass measurer | Medidor masa
corporal | Appareil indice masse corporelle
Plastica | Plastic | Plástico | Plastique

Ø 5,5 x 2 cm T7 1 x 1 cm 20/400



.02

43056 *kare*

Termometro digitale, pila a bottone inclusa | Digital thermometer, button
cells included | Termómetro digital, pilas botón incluidas | Thermomètre
digital, pile incluse
Plastica | Plastic | Plástico | Plastique

2,5 x 14,4 x 1 cm T7 2 x 1 cm 50/400



.02

48206 *prian*

Nastro metrico per il corpo | Body measuring tape | Cinta metrica para el
cuerpo | Ruban métrique pour le corps
Plastica | Plastic | Plástico | Plastique

8 x 5 x 2 cm T7 2 x 2 cm 24/240



.02

96061 *malene*

Matita | Pencil doctor | Lápiz | Crayon
Legno | Wood | Madera | Bois

23 cm T2 4 x 0,5 cm 50/500



35013 joakim

Cardiofrequenzimetro | Heart rate monitor | Medidor de frecuencia cardiaca |
Moniteur de fréquence cardiaque
Plastica | Plastic | Plástico | Plastique

25 x 4,6 x 2,5 cm 886 5 x 5 cm 50



.01



43021 flo

10 tovagliette compresse in astuccio | 10 shrink wipes in case | 10 toallitas
coprimidas en estuche | 10 serviettes comprimées en étui
Plastica | Plastic | Plástico | Plastique

23 cm 6 x 0,8 cm 50/400

.21



.02



35005 kasper

Misuratore di pressione, batterie non incluse | Pressure gauge meter, batteries not
included | Medidor de tensión, pilas no incluidas | Manomètre, piles non incluses
Plastica | Plastic | Plástico | Plastique

7,8 x 6,4 x 2,5 cm 883 x 1 cm 20



48013 kosi

10 fazzoletti 3 veli in pacchetto personalizzabile | 3-ply
tissues in printable | 10 pañuelos con 3 capas en paquete
personalizable | 10 Mouchoirs en papier Kleenex 3 voiles en
paquet personnalisable
Carta | Paper | Papel | Papier

5,5 x 8 x 2,2 cm AD6 (back side) 4 x 6,5 cm

10/300

.02

.01

.08

.07

.23



48235 *kvarnvik*

Portapastiglie con 2 scomparti. Batteria inclusa | 2 compartments pill box. Battery included | Pastillero de 2 compartimentos. Bateria incluida | Pillulier avec 2 compartiments. Batterie incluse
Plastica | Plastic | Plástico | Plastique

9,1 x 2 x 4,8 cm S2 200



.21



.05



48015 *leonz*

Portapillole 3 scomparti | Pill box with 3 compartments | Pastillero con 3 compartimentos | Porte pilules 3 compartiments
Plastica | Plastic | Plástico | Plastique

6 x 4 x 1,3 cm T6 3 x 1 cm 100/1000



.02

48033 *mariche*

Porta pillole con taglia pastiglie | Pill box with pill crusher | Pastillero con corta pastilla | Porte pillules avec coupe
Plastica | Plastic | Plástico | Plastique

9 x 4 x 1 cm T6 | UV9 5 x 2 cm 1/200



.08



.23



.01



.18

48208 *corallo*

Portapillole 4 scomparti | Pillbox, 4 compartments | Pastillero con 4 compartimentos | Pillulier avec 4 compartiments
Plastica | Plastic | Plástico | Plastique

7,8 x 1,6 x 6,3 cm T6 | UV2 4 x 4 cm 50/400



.21

48002 *uly*

Portapillole | Pillbox | Pastillero | Pillulier
Plastica | Plastic | Plástico | Plastique

2,1 cm Ø 7 cm T6 2 x 1 cm 50/300



.32

48009 *malwi*

Portapillole con 4 scomparti | Pill box with 4 compartments | Pastillero con 4 compartimentos | Porte pilules avec 4 compartiments
Plastica | Plastic | Plástico | Plastique

6 x 6 x 1,8 cm S2 1,5 x 1,5 cm 250/500

48021 *ludmi*

Portapillole con 3 scomparti | Pill box with 3 compartments | Pastillero con 3 compartimentos | Porte pilules avec 3 compartiments
Metallo | Metal | Metal | Métal

Ø 3,5 L7 | D8 Ø 2 cm 50/400



49037 *tad*

Portabadge con clip (min. d'ord. 100 pz) | Badge holder with clip (min. quantity 100 pcs) | Portabadge con clip (Min. 100 uds) | Porte badge avec clip (commande min. 100 pièces)
PVC

9,5 x 8 cm S2 3 x 3 cm 100/1000



49060 *affe*

Badge | Badge | Badge | Badge
PVC

10 x 9 cm S2 3 x 3 cm 200/2000

49000 *riyad*

Badge | Badge holder | Portabadge | Porte badge

PVC

11 x 17 cm S2 3 x 3 cm 200/2000



49055 *torsten*

Lanyard Badge | Lanyard Badge | Identificador Lanyard | Lanyard Badge
PVC, Poliestere | PVC, Polyester | PVC, Poliéster | PVC, Polyester

11,2 x 48,5 x 0,5 cm S2 3 x 3 cm 100/1000

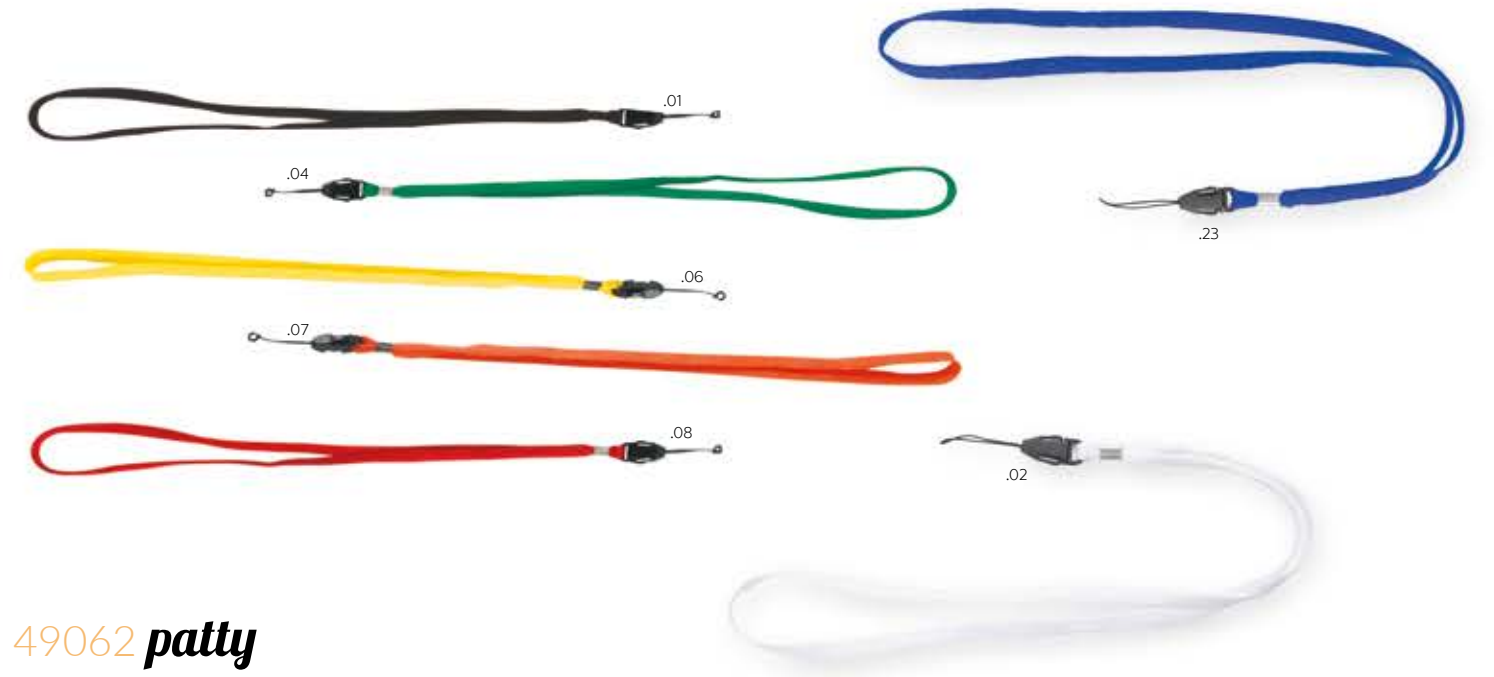

49062 *patty*

Lanyard con portacellulare | Lanyard with mobile phone hanger | Lanyard con portamóvil | Lanyard
Poliestere | Polyester | Poliéster | Polyester

0,5 x 90 cm 100/1000



49087 *colombo*

Lanyard regolabile con fibia per resinatura. | Lanyard with doming. | Lanyard con doming | Lanyard réglable avec boucle en doming
Poliestere | Polyester | Poliéster | Polyester

T7 | D10 100/1000

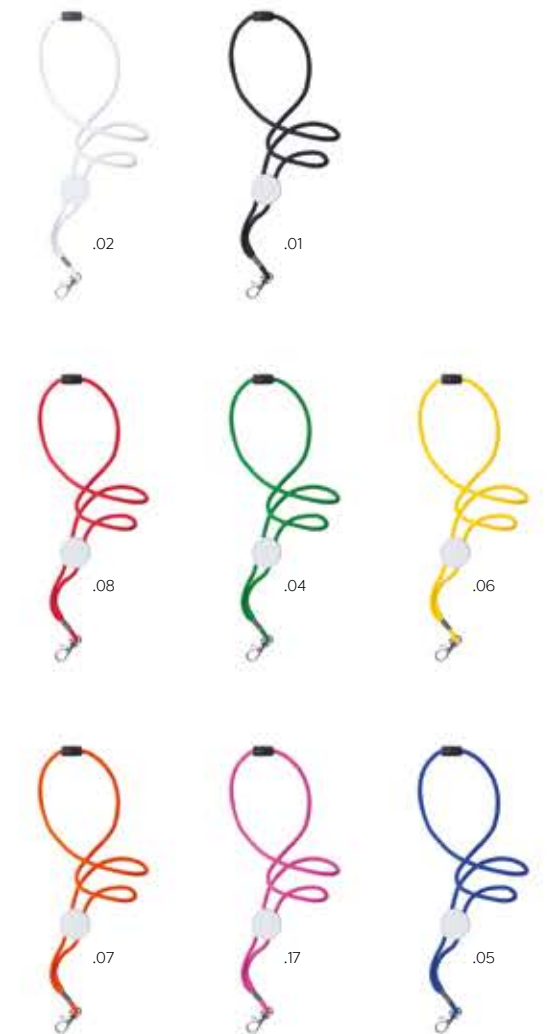



49032 **robert**

Lanyard con moschettone | Lanyard with mini carabiner | Lanyard | Lanyard

Poliestere | Polyester | Poliéster | Polyester

2 x 90 cm 🚰 SP35 (only for white colour) | BO 25 x 1 cm

📦 50/1000



49546 **roger**

Lanyard | Lanyard | Lanyard | Lanyard
Poliestere | Polyester | Poliéster | Polyester

1,2 x 50 cm 📦 100/1000

lanyard



49016 **gregor**

Portabadge con moschettone, gancio di sicurezza e dispositivo antisofoffamento | Lanyard with safety clip and keyholder | Lanyard con mosquetón y cierre de seguridad | Porte badge avec mousqueton, crochet de sécurité et dispositif anti étouffement
Poliestere, Plastica | Polyester, Plastic | Poliéster, Plástico | Polyester, Plastique

2 x 78 cm 🚰 SP35 (only for white colour) | SP36 | BO 25 x 1 cm 📦 50/500

ARE YOU LOOKING FOR A...

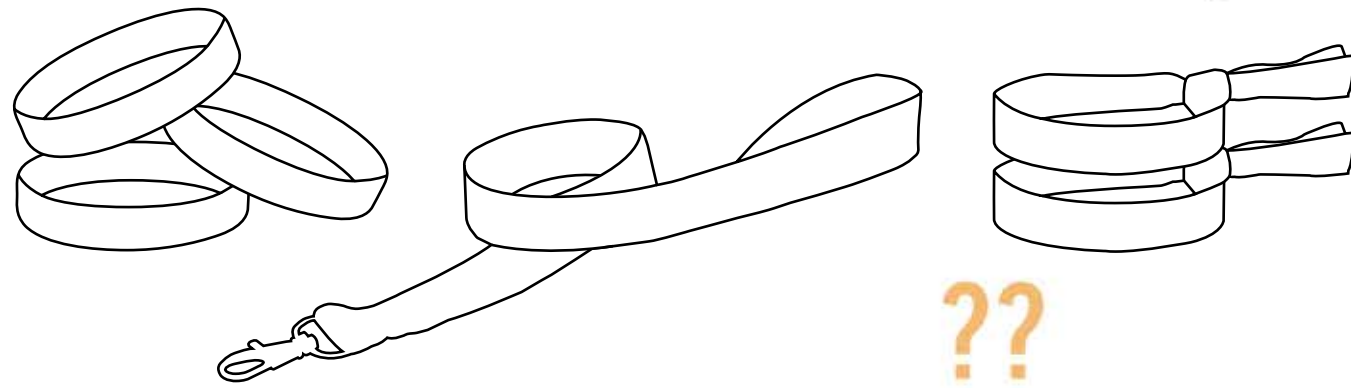

??

“ Take a look at import service chapter ”
pg. 747 -748



41108 pepper

Braccialetto con chiusura zip | Bracelet with zip | Pulsera con cierre cremallera
| Bracelet avec fermeture éclair
Plastica | Plastic | Plástico | Plastique

19 x 0,8 cm 100/2000



41001 thore

Braccialetto | Bracelet | Pulsera | Bracelet
Silicone | Silicone | Silicona | Silicóne

15 x 0,8 cm BO 100/1000

PRINTING EXAMPLE



41127 sundinga

Braccialetto | Bracelet | Pulsera | Bracelet
Poliestere | Polyester | Poliéster | Polyester

BO 100/1000

**your logo in full colour
starting from 250 pcs**



49021 norga

Portabadge | Portaskipass con clip e cordino lungo 80 cm ca | Badgelski pass holder with clip and 80 cm cord | Porta identificación con clip y cordón de 80 cm | Porte badge avec cordon et clip d'une longueur de 80 cm environ
Plastica, metallo | Plastic, metal | Plástico, metal | Plastique, métal

3,2 x 1,5 x 8 cm T11 Ø 1,5 cm 100/1000



49094 astana

Portachiavi con moschettone e porta badge estensibile. | Carabiner keyring and extendible badge holder | | Porte-clés avec mousqueton et porte-badge extensible

Plastica, metallo | Plastic, metal | Plástico, metal | Plastique, métal

T11 Ø 1 cm 50/500

CAPS

color your HEAD:

Cappelli per adulti e bambini, cappelli invernali, bandane, fasce, scaldaccolli e sciarpe.

318 - 329

berretti - caps and more - gorros - casquettes

100% cotton



Caps
319



16128 *feli*

Cappello golf, 5 spicchi, cinghietto per regolazione in velcro. Versione lux | Twill cotton 5 panels cap with adjustable plastic fastening. Lux version | Gorra golf, 5 paneles con cinta por regulacion en velcro. Version lux | Casquette 5 panneaux avec fermeture réglable à scratch. Version luxe
Cotone | Cotton | Algodón | Coton

☐ 22 x 15 cm ♀ S37 | TR16 8 x 5 cm 📦 50/200



RAP CAPS



16241 *kwart*

Cappellino traforato con regolazione in plastica | Perforated cap with snapback | Gorra perforada ajustable | Casquette avec filet antitranspirant et fermeture en plastique
Poliestere | Polyester | Poliéster | Polyester

58 cm 577 200

16242 *lack*

Cappellino a visiera piatta | Cap with flat visor | Gorra con visera plana | Casquette avec visière plate
Cotone, poliester | Cotton, polyester | Algodón, poliéster | Coton, polyester

58 cm 577 200



16074 *ege*

Cappello golf 6 pannelli in cotone pesante e chiusura con fibbia in metallo | Combed cotton 6 panels golf cap with metal buckle | Gorra golf 6 paneles con regulacion en metal y visera | Casquette en finette avec fermeture avec boucle en métal
Cotone pesante | Heavy cotton | Algodón grueso | Coton lourd

22 x 15 cm 537 | TR16 4 x 4 cm 25/100



16062 *simun*

Cappello golf 6 pannelli con regolazione in metallo e visiera interna verde da riposo | 6 panels golf cap with metal regulator and green visor | Gorra golf 6 paneles con regulacion en metal y visera interna verde da descanso | Casquette 6 panneaux avec fermeture réglable en métal et visière interne verte
Cotone | Cotton | Algodón | Coton

22 x 15 cm 537 | TR16 4 x 4 cm 50/200



16002 *gussago*

Cappellino traforato con regolazione in plastica | Perforated cap with snapback | Gorra perforado con regulacion en plástico | Casquette perforé avec réglage en plastique
Poliestere | Polyester | Poliéster | Polyester

58 cm 537 | SP22 5 x 8 cm 50/200

16017 *pembroke*

Cappello | Cap | Gorra | Chapeau
Poliestere | Polyester | Poliéster | Polyester

58 cm 537 | TR16 5 x 8 cm 25/200



16010 *gunes*

Cappellino con visiera a 5 pannelli, chiusura in velcro | Five panels cap with velcro fastening | Gorro de 5 paneles con ribete reflectante y cierre velcro | Casquette 5 panneaux avec fermeture réglable à scratch
TC Polycotton

21,5 x 17,5 cm 537 | TR16 8 x 5 cm 50/300

16057 *dogu*

Cappellino con visiera sandwich a 6 pannelli | Twill cotton 6 panels golf cap (sandwich peak) | Gorra de algodón de 6 paneles con visera sandwich | Casquette avec visière 5 panneaux
Cotone | Cotton | Algodón | Coton

20 x 26 cm 537 | TR16 | R 4 x 4 cm 50/200



16045 *kevin*

Cappellino a 6 pannelli con cinghietto per regolazione in velcro | 6 panels sandwich peak cap with velcro fastening | Gorra de 6 paneles con visiera sandwich y cierre velcro | Casquette 5 panneaux avec fermeture à scratch
Cotone | Cotton | Algodón | Coton

☞ Ø 20 x 26 cm ☞ S37 | TR16 4 x 4 cm ☞ 50/200



16052 *baler*

Cappellino 5 pannelli con visiera sandwich DELUX , cinghietto per regolazione in velcro | 5 panels sandwich peak cap with velcro fastening | Gorra de 5 paneles con visiera sandwich y cierre velcro | Casquette 5 panneaux avec fermeture à scratch
Cotone | Cotton | Algodón | Coton

☞ Ø 20 x 26 cm ☞ S37 | TR16 8 x 5 cm ☞ 50/200



100% COTTON



16192 *raja*

Cappello golf, 5 pannelli, ecru, con regolazione a velcro | 5 panels golf cap with velcro fastening | Gorra golf, 5 paneles, ecru, con regulacion e velcro | Casquette 5 panneaux avec fermeture à scratch
Cotone | Cotton | Algodón | Coton

☞ Ø 21,5 x 15 cm ☞ S37 | TR16 8 x 5 cm ☞ 50/200

16032 *doruk*

Cappellino con visiera 5 pannelli, cinghia con velcro | 5 panels cap with velcro fastening | Gorra de 5 paneles con cierre velcro | Casquette 5 panneaux avec fermeture à scratch
Cotone | Cotton | Algodón | Coton

☞ Ø 20 x 26 cm ☞ S37 | TR16 8 x 5 cm ☞ 50 / 200



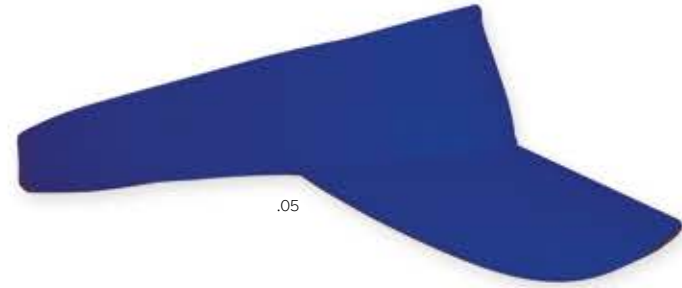

.05



.01

.02

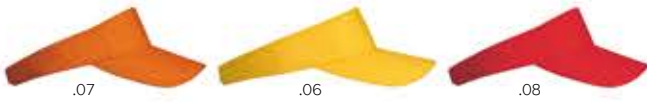

.07

.06

.08

16141 *laffi*

Visiera con chiusura elastica regolabile | Sun visor with adjustable elastic fastening | Visera de algodón con cierre ajustable | Visière avec fermeture élastique réglable
Cotone | Cotton | Algodón | Coton

☞ 24 x 16 x 8,5 cm ☞ S37 | TR16 7 x 2 cm ☞ 25/250



.07



.19

16096 *wilma*

Visiera in tessuto fluorescente, chiusura con velcro | Sandwich peak fluorescent sun visor | Visera sandwich con acabados reflectantes y cierre velcro | Visière en tissu fluorescent, fermeture à scratch
Cotone | Cotton | Algodón | Coton

☞ 20 x 26 cm ☞ S37 | TR16 7 x 2 cm ☞ 50/200



.02



.46



13412 *hasan*

Cappello miramare | Sun hat | Gorro | Chapeau miramare
Cotone | Cotton | Algodón | Coton

☞ 25 x 13 cm ☞ S37 | TR16 5 x 5 cm ☞ 50/300



13014 *kursk*

Cappello miramare Bicolore | Sun hat | Gorro | Chapeau miramare
Cotone | Cotton | Algodón | Coton

☞ 25 x 13 cm ☞ S37 | TR16 5 x 5 cm ☞ 50/300



.04



.01

.17

.07

.08

.06

.02

16016 *kulam*

Cappello, regolazione con velcro | Velcro adjustable cap | Gorra ajustable con velcro | Casquette réglable avec velcro
Microfibra e retina | Microfiber and mesh fabric | Microfibra y rejilla | Microfibre et filet

☞ 58 cm ☞ S37 | SP22 5 x 5 cm ☞ 25/200



.08



.23

.03

16014 *anam*

Cappello, regolazione con velcro | Velcro adjustable cap | Gorra ajustable con velcro | Casquette réglable avec velcro
Microfibra e retina | Microfiber and mesh fabric | Microfibra y rejilla | Microfibre et filet

☞ 58 cm ☞ S37 | SP22 6 x 5,5 cm ☞ 50/600



.45



.05



.48

13098 *halit*

Cappello Miramare Sandwich, Misura grande | Sun hat, Big size | Gorro miramare, sandwich, Tamaño grande | Grand chapeau miramare Sandwich
Cotone twist | Cottontwist | Algodón | Coton
Size XL

☞ 25 x 13 cm ☞ S37 | TR16 5 x 5 cm ☞ 50/300



.13

.10

.01

.23

.08

14611 *lezig*

Cappello invernale double-face, un lato in nylon impermeabile e un lato in pile | Double-face winter hat (waterproof nylon | pile) | Gorro invernale double-face, un lado en nylon impermeable y un lado en almorradas | Chapeau hivernal double-face, un coté en nylon imperméable et un autre en laine polaire
Pile, nylon | Fleece, nylon | Montón, nylon | Laine polaire, nylon

☞ 25 x 13 cm ☞ S37 5 x 5 cm ☞ 50/100



.23



16133 *ferit*

Cappello golf Bimbo, 5 spicchi, cinghietto per regolazione in velcro. Versione lux | 5 panels kids cap with velcro fastening. Lux version | Gorra golf nino, 5 paneles, con cita por regulacio en velcro. Versiòn lux | Casquette 5 panneaux pour enfant avec fermeture à scratch. Version luxe

Cotone | Cotton | Algodón | Coton

☞ ☞ ☞ Ø 17 x 24 cm ☞ ☞ S37 | TR16 6 x 3 cm ☞ 50/200



.02



.08



16049 *finley*

Cappellino bambino con visiera 6 pannelli, bicolore | 6 panels kids cap with velcro fastening | Gorro infantil de algodón de 6 paneles con cierre velcro | Casquette bicolore pour enfants avec 6 panneaux et fermeture à scratch

Cotone | Cotton | Algodón | Coton

☞ ☞ ☞ Ø 17 x 24 cm ☞ ☞ S37 | TR16 4 x 4 cm ☞ 50/200



.06



49974 *saturno*

Scaldacollo | Neck Warmer | Calienta cuellos en poliéster | Tour de Cou
Poliestere | Poliestere | Poliestere | Poliestere

☞ ☞ ☞ 25 x 47 cm ☞ ☞ S9 | SP22 (only on white colour) 5x5 cm ☞ 300



.04



19009 *fraser*

Foulard | Triangle shaped headkerchief | Foulard | Bandana
Poliestere | Polyester | Poliéster | Polyester

☞ ☞ ☞ 120 x 55 x 55 cm ☞ ☞ S75 | SP22 (only on white colour)
10 x 10 cm ☞ 10/1000



14773 *kwissle*

Set di guanti e berretto con pochette | Gloves and cap with pouch | Conjunto de guantes y gorro con funda | Set gants et chapeau avec pochette
Poliestere | Polyester | Poliéster | Polyester

☞ 18 x 25 x 1,8 cm ☞ S76 ☞ 100



14753 *yossel*

Sciarpa | Scarf | Bufanda | Écharpe
Pile | Fleece | Tejido polar | Laine polar

☞ 150 x 25 cm ☞ S42 | TR15 8 x 8 cm ☞ 1/60



14760 *patrick*

Berretto personalizzabile | Customizable cap | Gorro personalizable | Bonnet personnalisable
Poliestere | Polyeste | Poliéster | Polyester

☞ 19,5 x 19,5 cm ☞ TR16 7 x 3 cm ☞ 1/250



14741 *jakob*

Berretto | Hat | Gorro | Bonnet
Pile | Fleece | Tejido polar | Laine polaire

☞ Ø 25 cm ☞ TR16 7 x 3 cm ☞ 1/100



14004 *akron*

Guanti | Gloves | Guantes | Gants Pile: 200g/m² | Fleece: 200g/m² | Tejido polar: 200g/m² | Polaire 200g/m²

☞ Size 8 ☞ TR23 S14 4 x 4 cm ☞ 1/200



14743 *pacey*

Sciarpa | Scarf | Bufanda | Echarpe
Pile | Fleece | Tejido polar | Laine polaire

☞ 150 x 20 cm ☞ S42 | TR15 8 x 8 cm

☞ 10/100



14014 *grantorto*

Scaldacollo per doppia stagione | Neck warmer | Braga cuello bicolor | Tour de cou
Poliestere/Pile | Polyester/polar fleece | Poliéster/Polar | Polyester/Pile

☞ 25 x 65 cm ☞ S37 | TR16 | R 5 x 5 cm

☞ 10/100



14140 *fornalutx*

Sciarpa | Scarf | Bufanda | Écharpe Pile 180 gr. | Polar fleece 180 gr | Polar 180 gr | Polaire 180 gr

☞ 91 x 12 cm ☞ S42 | TR15 8 x 8 cm

☞ 10/400

14772 *oscar kids*

Scaldacollo-cappello regolabile con laccio | Hat-scarf combination with adjustable cord | Gorro transformable en braga para el cuello | Chauffe-cou ou chapeau réglable avec coulisse
Pile | Fleece | Tejido polar | Laine polaire

☞ 24 x 22 cm ☞ S37 | TR16 5 x 5 ☞ 10/100



14739 *oscar*

Scaldacollo-cappello regolabile con laccio | Hat-scarf combination with adjustable cord | Gorro transformable en braga para el cuello | Chauffe-cou ou chapeau réglable avec coulisse
Pile | Fleece | Tejido polar | Laine polaire

☞ 26,5 x 22 cm ☞ S37 | TR16 5 x 5 ☞ 10/100



BUSINESS

core of YOUR

Porta biglietti da visita, porta documenti, set da ufficio. Cartelle porta blocco con calcolatrice. Cartelle multitasche, supporto per tablet. Agende e block notes, gomme, righelli e porta CD.

330 - 371

business



Business
331

40170 *stocksund*

Set femminile block notes e penna in confezione regalo | Notebook and ballpen lady's gift set | Set femenino de libreta y bolígrafo en estuche regalo | Set pour femme bloc note et stylo avec boîte cadeau
Metallo, PU | Metal, PU | Metal, PU | PU, métal, carton

13 x 18 x 1,5 cm S86 9 x 15 cm



40003 *anze*

Porta biglietti da visita | Business card holder | Portatarjetas | Porte carte de visite
Alluminio | Aluminium | Aluminio | Aluminium

9,3 x 5,9 x 0,5 cm T7 | L7 4 x 2 cm 100/500



40059 *nupa*

Porta biglietti da visita | Business card holder | Portatarjetas | Porte carte de visite
Alluminio, Similpelle | Aluminium, Imitation leather | Aluminio, Polipiel | Aluminium, Simil Cuir

9,6 x 6,4 x 0,9 cm T7 | L7 3,5 x 1 cm 100/500



62992 *uluwatu*

Cartella portadocumenti con diverse tasche interne per biglietti e carte. Include block notes e calcolatrice | Document folder with pockets for cards in the inside. Memo pad and calculator included | Portafolios con diferentes bolsillos para tarjetas y documentos. Incluye calculadora y bloc | Porte documents avec poches internes. Bloc notes et calculatrice inclus
PU

26 x 33,5 cm 12 x 10 cm 20



24001 *pingu*

Set porta biglietti da visita con penna a sfera, in scatola regalo | Business card holder with ballpoint pen, in gift box | Estuche portatarjetas con bolígrafo en caja de regalo | Ensemble porte carte de visite et stylo à bille avec boîte cadeau
Metallo | Metal | Metal | Métal

16 x 17 cm S86 5 x 5 cm 100



24012 *noumea*

Set da ufficio con calcolatrice, righello e penna a sfera | Office set with calculator, ruler and ball pen, supplied in a presentation box | Juego de sobremesa incluyendo calculadora, regla y bolígrafo | Ensemble calculatrice, stylo et règle avec boîte cadeau
Metallo | Metal | Metal | Métal

17 x 24 x 3,5 cm S86 5 X 5 cm 50 / 200

BUSINESS CARD holder



41354 *agri*

Porta carte di credito 6 scomparti | Credit card holder with 6 compartments | Tarjetero 6 compartimentos | Porte-cartes de crédits. 6 places
Alluminio | Aluminium | Aluminio | Aluminium

7,5 x 2 x 11 cm T7 | L7 4 x 2 cm 50/200



DOCUMENT *folder* with calculator

62046 *bridgetown*

Cartella portablocco con calcolatrice. Blocco da 20 fogli e calcolatrice inclusi | Briefcase with calculator and notebook 20 sheets | Portapapeles con calculadora y bloc de notas 20 hojas (Boli no incluido) | Porte-documents avec calculatrice et bloc-note 20 feuilles (stylo non inclus)

Microfibra-PU | Microfiber- Imitation leather | Microfibra-polipiel Microfibre-Similcuir

24,5 x 33 x 2 cm S69 5 x 5 cm 20

Business
334



62022 *joanna*

Portablocco A4 con zip, block notes 20 pag e calcolatrice 8 cifre dual power (penna esclusa) | A4 document folder with zip, 20 pages notepad and 8-digits dual power calculator (pen excluded) | Carpeta A4 con bloc de notas de 20 hojas y calculadora 8 digitos (boligrafo excluido) | Porte bloc A4 avec fermeture éclair, bloc notes 20 pg et calculatrice 8 chiffres dual power (stylo non inclus)

Microfibra | Microfiber | Microfibra | Microfibre

24,5 x 32,5 x 4 cm S69 | L15 5 x 5 cm / 2 x 0,8 cm 1/20



62086 *may*

Portablocco A4, con calc. 8 cifre dual power | A4 conference folder with 8-digits dual power calculator | Carpeta congresos A4 con calculadora de 8 digitos | Porte bloc A4 et calculatrice 8 chiffres dual power

Similpelle | Imitation Leather | Polipiel | Similcuir

25 x 32 x 2 cm S69 | H2 5 x 5 cm 1/20



62090 *kamo*

Portablocco A4 con zip, block notes 20 pagine e calcolatrice 8 cifre dual power (penna esclusa) | A4 document folder with zip, 20 sheets block-notes and 8 digits calculator. Pen excluded | Carpeta A4 con bloc de notas de 20 hojas y calculadora 8 digitos (boligrafo excluido) | Porte bloc A4 avec fermeture éclair, bloc notes 20 pages et calculatrice 8 chiffres dual power (stylo non inclus)

Similpelle | Imitation Leather | Polipiel | Similcuir

25 x 34 x 2 cm S69 | H2 5 x 5 cm 1/12

BUSINESS

block notes



62032 *pivi*

Cartella multitasche con blocco | Multi pockets document folder with block-notes | Carpeta con bloc de notas | Porte documents multitache avec bloc
 Poliestere 600D | Polyester 600D | Poliéster 600D | Polyester 600D

25 x 34,5 cm S68 5 x 5 cm 1/20



62991 *dreamland*

Cartella portadocumenti con cerniera e tasche interne per biglietti e carte. Include block notes | Document folder with zip closure and pockets for cards in the inside. Memo pad included | Portafolios con cierre de cremallera y bolsillos para tarjetas en el interior. Incluye bloc de notas | Porte documents avec fermeture éclair et poches internes. Bloc notes inclus
 Poliestere 600D | Polyester 600D | Poliéster 600D | Polyester 600D

24,5 x 2 x 34 cm S68 15 x 25 cm 20



61629 *winona*

Porta documenti con blocco 20 fogli | Ring binder document folder with 20 sheets block-notes | Carpeta congresos con 20 hojas | Porte documents avec bloc de 20 feuilles
 Poliestere, Microfibra | Polyester, Microfiber | Poliéster, Microfibra | Polyester, Microfibres

37 x 27,5 x 5 cm S69 L15 5 x 5 cm 1/12



61600 *pajak*

Portadocumenti. Include blocco 20 Fogli | Document folder with 20 sheets block-notes | Portadocumentos. Incluye bloc 20 hojas | Porte document, inclus un bloc de 20 feuilles
 Microfibra | Microfiber | Microfibra | Microfibres

32,5 x 24,5 x 2 cm S69 L15 5 x 5 cm 1/20

DOCUMENT folder



62034 *angela*

Portablocco A4 con block notes 20 pag (penna esclusa) | A4 document folder with 20 pages notepad (pen excluded) | Carpeta A4 con bloc de notas de 20 hojas (bolígrafo excluido) | Porte bloc A4 avec bloc notes 20 pages (stylo non inclus)
 Poliestere 600D | Polyester 600D | Poliéster 600D | Polyester 600D

24 x 32 x 1 cm S68 5 x 5 cm 1/20



62037 *passion*

Cartella con Blocco 20 Fogli | Document Folder with 20 Sheets Notepad | Carpeta con 20 hojas | Porte-Documents avec bloc-note 20 Pages
 Microfibra | Microfibre | Microfibra | Microfibre

26 x 20,5 x 2,5 cm S68 5 x 5 cm 20



62900 *locarno*

Portadocumenti | Document folder | Portadocumentos | Porte-documents PU

26 x 25 x 33 cm S69 L15 5 x 5 cm 20



61042 *nami*

Portablocco, formato A4, chiusura con zip e targhetta in metallo, penna esclusa | A4 conference folder with zipper in box. Pen excluded | Carpeta congresos A4 (sin bolígrafo) | Porte bloc, format A4, fermeture éclair et plaquette en métal (stylo non inclus)
 Similpelle, Microfibra | Imitation leather, Microfibre | Polipiel, Microfibra | Similcuir, Microfibre

27 x 35 x 4 cm S69 L15 5 x 5 / 2 x 0,8 cm 5/20



.05

27650 **siska** 

Organizer con penna | Organizer with pen | Agenda con bolígrafo | Agenda avec stylo
PVC

 17 x 10,5 x 3 cm  S3 6 x 3 cm  1/20

ORGA nizer



.05

.01

.08

.06

.02

62038 **mirtyfoglia**

Cartella con blocco (50 Fogli), penna esclusa | Document Folder with 50 Sheets Notepad. Pen excluded | Carpeta con 50 hojas, bolígrafo excluido | Porte-Documents avec bloc 50 Pages, stylo non inclus
Similpelle | Imitation leather | Polipiel | Similcuir

 17,8 x 22 x 1 cm  S68 | L13 5 x 5 cm  40

27506 **giuggiole**

Custodia con blocco, calcolatrice | Notepad with block, calculator | Bloc de notas con calculadora | Porte-documents avec bloc notes, calculatrice
Similpelle | Imitation leather | Polipiel | Similcuir

 10 x 15 x 2 cm  S3 5 x 5 cm  100



.19

.08



.01

.05

62990 **smycka**

Portadocumenti con blocco fogli a righe, portapenna, tasca interna con diversi scomparti | Documents holder with striped notebook. Pen holder and pockets for cards and documents | Portafolios con libreta a rayas. Con varios bolsillos para tarjetas y documentos y sujeta bolígrafo | Porte documents avec bloc notes rayé, porte stylos, poche interne avec plusieurs compartiments

Pen excl.
Similpelle | Imitation leather | Polipiel | Similcuir

 31 x 24 x 1 cm  S68 5 x 5 cm  40



62987 söderhamn

Portadocumenti con supporto per smart phone e tablet. Con blocco fogli a righe e calendario, portapenna, tasca interna con diversi scomparti. Chiusura magnetica | Documents holder with tablet and smart phone support. With striped notebook and calendar on every page. Pen holder and pockets for cards and documents. Magnetic closure | Portafolios con soporte para tablet y smart phone. Con libreta a rayas y calendario. Con varios bolsillos para tarjetas y documentos y sujeta bolígrafo. Cierre magnético | Porte documents avec support pour smartphone et tablette. Contenant bloc notes rayé avec calendrier, porte stylos, poche interne avec compartiments. Fermeture magnétique

Pen excl.
 Similpelle | Imitation leather | Polipiel | Similcuir
 31 x 23,5 x 1 cm 🚰 S68 15 x 12 cm 📦 20

40177 zambia

Block notes a righe con copertina portapenna e portabiglietti | Striped notepad with pen and card holder on the cover | Bloc de notas rayado con portaminas y portatarjetas | Bloc-notes rayé avec porte-stylo et porte-billets en couverture

Pen excl.
 Similpelle | Imitation leather | Polipiel | Similcuir
 21 x 14 x 1,5 cm 🚰 S86 4 x 4 cm 📦 50



62988 padang

Cartella portadocumenti A4 con diverse tasche e vani per dispositivi elettronici. Chiusura a zip. Include block notes | A4 document folder with pockets for electronic devices. Zip closure. Memo pad included | Portafolios A4 con departamentos y bolsillos para dispositivos electrónicos. Cierre de cremallera. Incluye libreta | Porte documents A4 avec plusieurs poches porte objets. Fermeture éclair. Bloc notes inclus

Pen excl.
 Similpelle | Imitation leather | Polipiel | Similcuir
 26 x 2 x 34 cm 🚰 S68 15 x 12 cm 📦 20



62989 kuta

Cartella portadocumenti A4 con molti spazi all'interno e block notes da 20 pagine. Chiusura magnetica | A4 document folder with pockets in the inside and notebook. Magnetic closure | Portafolios A4 con varios departamentos en su interior. Con libreta y cierre magnético | Porte documents A4 avec plusieurs poches porte objets et bloc notes de 20 pages. Fermeture magnétique. Pen excl.

Poliestere, PU | Polyester, PU | Poliéster, PU | Polyester
 23,5 x 2 x 31 cm 🚰 S68 15 x 12 cm 📦 25





.08



62068 *nanga*

Cartella portadocumenti con portablocco da 20 fogli | Document folder with 20 sheets | Carpeta portadocumentos con 20 hojas | Porte-documents avec 20 feuilles

Poliestere 600D | Polyester 600D | Poliéster 600D | Polyester 600D

32,3 x 3 x 24,5 cm 568 5 x 5 cm 20



.04



62053 *himalaya*

Cartella portadocumenti con portablocco da 20 fogli | Document folder with 20 sheets | Carpeta portadocumentos con 20 hojas | Porte-documents avec 20 feuilles

Poliestere 600D | Polyester 600D | Poliéster 600D | Polyester 600D

32,3 x 1 x 24,8 cm 568 5 x 5 cm 40

COLOURS series



.23

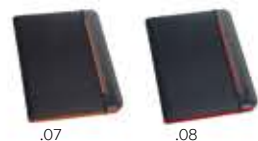

62004 *miko*

Portablocco A4 con 20 pagine, penna esclusa | A4 document folder, 20 pages. Pen excluded | Carpeta A4 con 20 hojas, bolígrafo no incluido | Porte bloc A4 avec 20 feuilles, stylo non inclus
Poliestera 800D, PU, Microfibre | Polyester 800D, PU, Microfibre | Poliéster 800D, PU, Microfibras | Polyester 800D, PU, Microfibre

25 x 31,5 x 1,5 cm 568 5 x 5 cm 1/20



.02

61025 *volko*

Clip con calcolatrice | Clip board with calculator | Calculadora pinza | Calculatrice tapis de souris

Plastica | Plastic | Plástico | Plastique

21,5 x 3 x 33,5 cm 18 5 x 5 cm 10/40

DOCUMENT holder



.08

.02

.01

.23

61011 *tadita*

Portablocco con pinza | Clip board | Carpeta con pinza | Porte bloc avec pince
PVC rigido | Rigid PVC | PVC rígido | PVC rigide

32 x 25 cm 566 5 x 5 cm 1/40

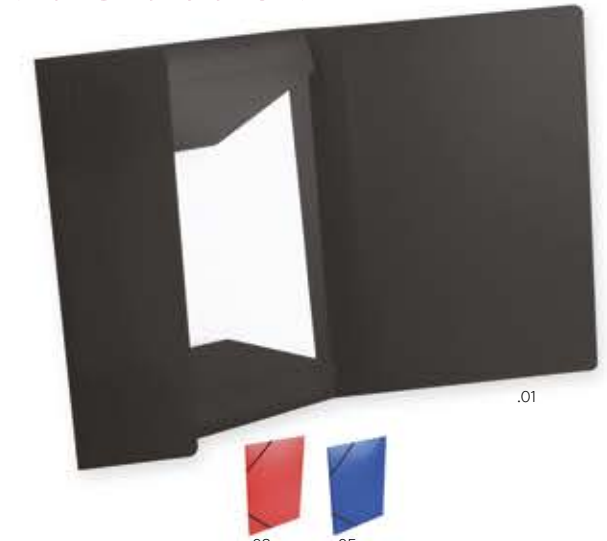

.01

.08

.05

60022 *winema*

Cartellina A4 portadocumenti con elastico | A4 document holder with elastic string | Carpeta A4 con elástico | Cartable A4 porte documents avec élastique
Plastica | Plastic | Plástico | Plastique

32 x 24 cm 566 7 x 7 cm 35/140



Business
344

62073 nordli

Portablocco notes con power bank 3000 mAh. Cavo Incluso |
Notepad holder with power bank 3000 mAh. Cable Included | Bloc
power bank 3000 mAh con cable incl. | Porte documents avec bloc
notes et power bank 3000 mAh. Câble inclus
Similpelle | PU | Polipiel | PU

17,5 x 22,5 x 2,5 cm 6 x 6 cm 20

62984 malasya

Supporto per tablet | Tablet stand | Soporte para tableta |
Supports pour tablet
Similpelle | Imitation leather | Polipiel | Similicuir

20 x 25 x 2,5 cm S69 | H2 5 x 5 cm 50

62059 grassobbio

Porta documenti con 20 fogli inclusi e powerbank 5000mAh (Cavo
incluso) | A4 folder with power bank 5000 mAh. Cable included
and notepad. | Portadocumentos A4 con power bank 5000 mAh.
Cable y bloc-notas incluido. | Porte-document avec 20 feuilles
incluses et power bank 5000 mAh (Cable inclus)
Similpelle | Imitation leather | Polipiel | Simili-cuir

26,5 x 34 x 4,5 cm S3 | H2 | L15 5 x 5 cm / 2 x 0,8 cm

1/20



62985 sockerkaka

Portadocumenti con blocco fogli a righe e calendario,
portapenna, tasca interna con diversi scomparti. Chiusura
con cintura di gomma | Documents holder with striped
notebook and calendar on every page. Pen holder and
pockets for cards and documents. Closure with rubber
belt | Portafolios con libreta a rayas y calendario. Con
varios bolsillos para tarjetas y documentos y sujeta
bolígrafo. Cierre con cinturón de goma | Porte documents
avec bloc notes rayé et calendrier, porte stylos, poche
interne avec plusieurs compartiments. Fermeture avec
ceinture gommée. Pen excl.

Poliestere | Polyester | Poliéster | Polyester

31 x 23,5 x 1 cm



.03 .01 .05 .10



40281 songesand

Portadocumenti con block notes a righe. Condiversi scomparti per
tessere e documenti | Documents holder with striped notebook and
pockets for cards and documents | Portafolios con libreta a rayas. Con
varios bolsillos para tarjetas y documentos | Porte documents avec
bloc notes rayé avec plusieurs compartiments porte documents. Pen
excl.

Poliestere | Polyester | Poliéster | Polyester

22,5 x 16,5 x 2 cm S86

Business
345





40182 *mweru*

Block notes A5. 80 pagine | A5 notebook. 80 pages | Libreta A5. 80 páginas | Bloc notes format A5. 80pages

Carta | Cardboard | Papel | Papier

14,7 x 21 x 1,1 cm S2 5 x 5 cm 50

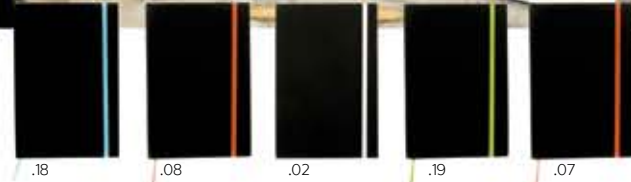

40121 *frisco*

Blockno con 40 fogli | Block-notes with 40 sheets | Cuaderno con 40 hojas | Bloc-notes 40 feuilles

Carta riciclata | Recycled cardboard | Papel reciclado | Papier recyclé

14 x 21 cm S65 | UV8 10 x 10 cm 20/120



40070 *riami*

Block notes con laccio | Moleskine with cord | Bloc notas con cuerda | Bloc notes avec cordon

Similpelle, carta | Imitation leather, paper | Polipie, papel | Similcuir, papier

8,5 x 12 cm S96 3 x 3 cm 30/60



40280 *stenstorp*

Block notes a righe con elastico portatutto sulla copertina | Striped notebook with elastic holder on the cover | Libreta a rayas con goma en la portada para sujetar objetos varios | Bloc notes rayé avec elastiques porte objets sur la couverture. Pen excl.

Poliestere | Polyester | Poliéster | Polyester

14 x 21,5 cm L9



.03



40279 *stäm*

Block notes a righe con elastico portatutto sulla copertina | Striped notebook with elastic holder on the cover | Libreta a rayas con goma en la portada para sujetar objetos varios | Bloc notes rayé avec elastiques porte objets sur la couverture. Pen excl.

14 x 21,5 cm S100

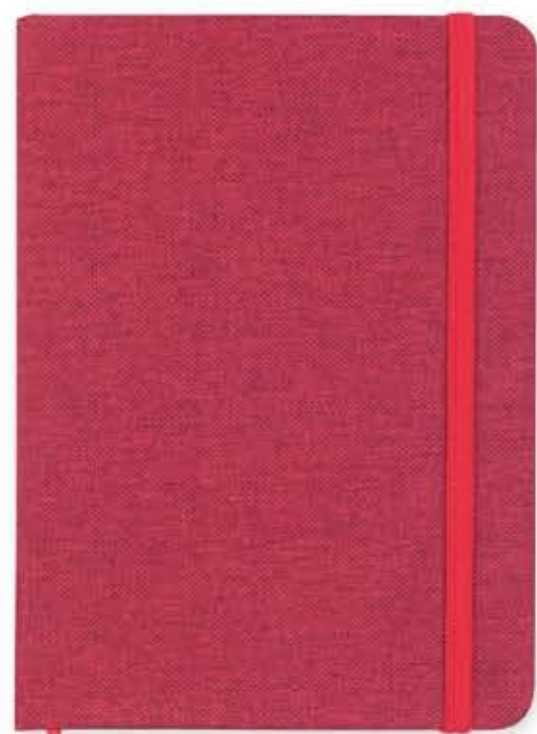

.08



.03



.05

40153 *cedrus*

Block notes con elastico, 96 pagine bianche | Notepad with elastic closing, 96 sheets | Bloc de notas con elástico, 96 hojas | Bloc notes avec élastique, 96 feuilles

Poliestere 600d | Polyester 600d | Poliéster 600d | Polyester 600d

18 x 13 x 1,5 cm ♻️ S65 5 x 5 cm 📦 1/50

BLOCK NOTES

A5



.06

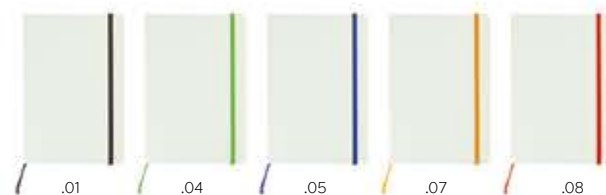

.01

.04

.05

.07

.08

40163 *gonzaga*

Blocco A5 con elastico, fogli a righe | A5 Notebook | Bloc de notas A5 | Carnet format A5 avec élastique en couleur Similpelle | PU | Polipiel | Similcuir

14,5 x 21 x 1,5 cm ♻️ S2 5 x 4 cm 📦 25/50

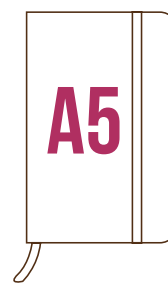

40274 *koncis*

Block notes A5 con copertina rigida, 100 pagine | A5 notebook with rigid cover, 100 pages | Libreta A5 de tapa dura, 100 páginas | Bloc notes format A5 avec couverture rigide, 100pages

Carta riciclata | Recycled Cardboard | Papel reciclado | Papper recycld

14,7 x 21 x 1,5 cm ♻️ S76 📦 50



40275 *korken*

Block notes A6 con copertina rigida, 100 pagine | A6 notebook with rigid cover, 100 pages | Libreta A6 de tapa dura, 100 páginas | Bloc notes format A6 avec couverture rigide, 100pages

Carta riciclata | Recycled Cardboard | Papel reciclado | Papper recycld

9,5 x 14,5 x 1,5 cm ♻️ S78 📦 100

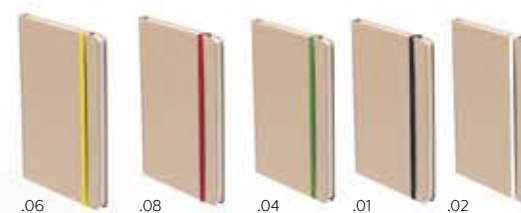

.06

.08

.04

.01

.02



.23



40105 gadoni

Moleschino 80 pg. | Moleskine 80 pag. | Moleskine | Moleskine
Cartone | Carton | Papel | Cartón

9 x 14 x 1,3 cm S64 | UV9 4 x 4 cm 25/100



40131 gloucester

Block notes con 80 fogli | Notebook with 80 sheets | Bloc de notas con 80 hojas | Bloc notes avec 80 feuilles
Similpelle | Imitation leather | Polipiel | Similcuir

14,3 x 9,1 x 1,4 cm S64 | UV9 4 x 4 cm 100

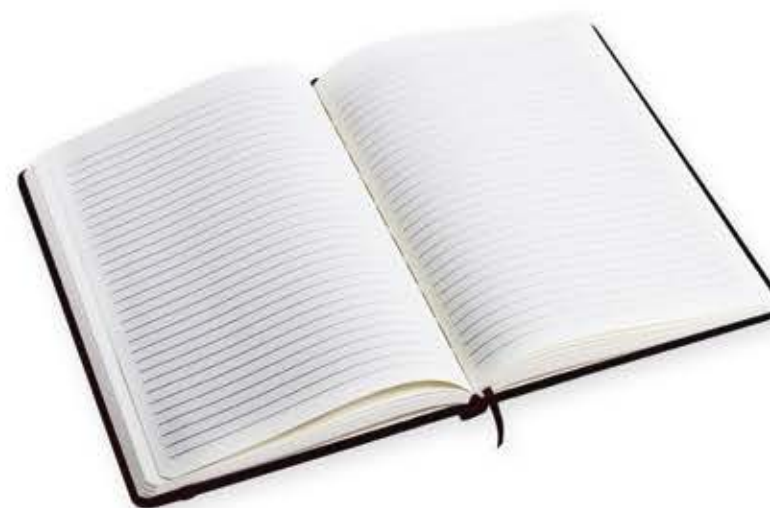

40157 moomin

Bloc notes con copertina rigida. | Notebook with lined sheets, hardcover. | Bloc de notas con hojas a rayas | Carnet avec couverture rigide. 80 pages avec lignes.
Similpelle | Imitation leather | Polipiel | Similcuir

14,7 x 21 x 1,2 cm S2 | H1 | UV8 5 x 5 cm 25/50



40165 lucca

Bloc notes. 80 pagine | Notebook with 80 sheets. | Bloc de notas con 80 hojas | Carnet 80 pages sans lignes.
Similpelle | Imitation leather | Polipiel | Similcuir

14,7 x 21 x 1,2 cm S2 | H1 | UV8 5 x 5 cm 25/50



40074 *garm*

Block Notes con 100 fogli | Notepad (100 sheets) | Bloc notas con 100 hojas | Bloc notes avec 100 feuilles
Similpelle | Imitation leather | Polipiel | Similcuir

14,7 x 21 x 1,5 cm ♻️ S65 | UV8 5 x 5 cm 📦 25/50

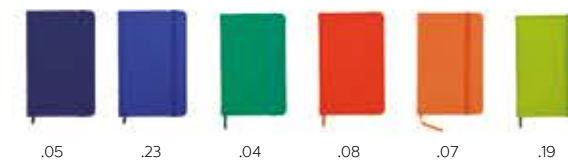

40031 *utina*

Block notes con 100 fogli | Moleskine with 100 sheets | Bloc notas con 100 hojas | Bloc notes avec 100 feuilles
Similpelle | Imitation leather | Polipiel | Similcuir

14 x 9 x 1,4 cm ♻️ S64 | UV9 4 x 4 cm 📦 25/100



40161 *diamond*

Blocchetto con elastico e penna inclusa | Notebook, ball pen included | Bloc de notas con boligrafo | Bloc note avec élastique et stylo inclus
Cartone | Caraboard | Carton | Carton

10 x 7,5 cm ♻️ S1 3 x 3 cm 📦 25/100





40126 *gante*

CHOOSE
your size



40159 *givoletto*

Quaderno con copertina rigida | Notebook, hardcover | Bloc de notas con tapa rigida | Carnet avec couverture rigide
Similpelle | Imitation leather | Polipiel | Simili-cuir
📏 21 x 29 cm 🌿 S2 | H1 | UV8 5 x 5 cm 📦 10

40231 *suzhou*

Quaderno con copertina rigida e tasca interna. 80 fogli avorio senza righe. Chiusura con elastico | Notepad, hardcover with inner pocket and 80 ivory plain sheets | Bloc de notas con bolsillo interno (80 hojas de marfil) | Carnet avec pochette interne (80 feuilles ivoire)
Similpelle | Imitation leather | Polipiel | Similicuir

📏 9,7 x 14,5 cm 🌿 S64 | UV9 | H1 5 x 5 cm 📦 1/60

40095 *lina*

Quaderno con copertina rigida e tasca interna. 80 fogli bianchi. Chiusura con elastico | Notepad, hardcover with inner pocket and 80 ivory plain sheets | Bloc de notas con bolsillo interno (80 hojas de marfil) | Carnet avec pochette interne (80 feuilles ivoire)
Similpelle | Imitation leather | Polipiel | Similicuir

📏 13,7 x 21 cm 🌿 S65 | UV8 | H1 5 x 5 cm 📦 24



40160 *gobots*

Quaderno con copertina rigida (fogli a quadretti) (penna esclusa) | Notebookm hardcover with squared sheets (pen excluded) | Bloc de notas con hojas a cuadros (bolígrafo excluido) | Carnet avec couverture rigide (interieur feuilles à carreaux) (stylo non inclus)

Similpelle | Imitation leather | Polipiel | Simili-cuir
📏 14,7 x 21 x 1,5 cm 🌿 S2 | H1 | UV8 5 x 5 cm 📦 25/50



40126 *gante*

Blocco con copertina rigida, con tasca interna e 80 fogli avorio a righe (penna esclusa) | Block-notes with hardcover, internal pocket and 80 lined sheets (pen excluded) | Cuaderno con tapa rigida, bolsillo interno y 80 hojas a rayas (bolígrafo excluido) | Bloc-notes avec couverture rigide, avec poche intérieure et 80 feuilles ivoire (stylo non inclus)

Carta | Paper | Papel

📏 13,7 x 21 cm 🌿 S65 | UV8 | H1 5 x 5 cm 📦 1 / 24



40239 *beethoven*

Block notes con penna. 50 fogli | Ball pen with notebook. 50 sheets | Libreta con bolígrafo. 50 hojas | Bloc note avec stylo. 50 feuilles
Cartone riciclato | Carton | Cartón | Carton

8,6 x 11,7 x 1,3 cm ♻️ S64 | T4 4 x 4 cm 📦 100

40277 *knalla*

Block notes con penna. 70 fogli bianchi lisci. | Notebook with ballpen. 70 plain pages | Libreta con bolígrafo. 70 páginas lisas | Bloc note avec stylo. 80 feuilles
Cartone riciclato | Recycled paperboard | Cartón reciclado | Papier recyclé

15 x 18,2 x 1,9 cm ♻️ S100 4 x 4 cm 📦 50

40240 *belfy*

Block notes con penna. 80 fogli | Ball pen with notebook. 80 sheets | Libreta con bolígrafo. 80 hojas | Bloc note avec stylo. 80 feuilles
Cartone riciclato | Carton | Cartón | Carton

23,7 x 29 x 2 cm ♻️ S66 | T4 4 x 4 cm 📦 100



WATERPROOF
notepads are 100 % waterproof

GREASEPROOF
notepads can be used even with greasy hands

ECOLOGICAL
paper is an environmental friendly choice

40162 *grimaldi*

Bloc notes con 30fg.a quadretti | Notebooks with 30 squared sheets. | Bloc de notas con hojas de papel piedra | Bloc note 30 feuilles Pietra | Paper Stone | Piedra | Papier de pierre

15 x 10 cm ♻️ S1 5 x 3 cm 📦 50/100



40154 *manama*

Block notes a righe con elastico e penna touch screen | Notepad with lined sheets, elastic closing and touch screen ball pen | Bloc de notas con hojas a rayas, elástico y bolígrafo con puntero táctil | Bloc notes avec feuilles lignées, élastique et stylo à bille avec pointeur tactile
Polipropilene | Polipropilen | Propileno | Propylène

21,5 x 17 x 1 cm ♻️ S65 | T4 5 x 5 cm 📦 1/50



40141 *vladimir*

Block notes A5 con 80 pagine | Block note A5 (80 sheets) | Block note A5 (80 sheets) | Bloc notes, A5, 80 pages
Carta | Paper | Papel | Carton

15,5 x 21 cm ♻️ S65 5 x 5 cm 📦 60

NOTE *pad*

Business
358



40283 *valverde*

Block notes A5 con chiusura elastica e copertina metallizzata. 80 pagine | Notebook A5 with elastic closure and metallic finish cover. 80 pages | Libreta A5 con cierre elástico y tapa metalizada. 80 páginas | Bloc-notes A5 avec fermeture élastique et couverture métallique. 80 pages
Similpelle | Pu | Polipiel | PU

14,5 x 21 cm 5,5 x 5,5 cm 50



.01



.01

40172 *sunnersta*

Set maschile block notes e penna | Notebook and ballpen male set | Set caballero de libreta y bolígrafo en estuche regalo | Set pour homme bloc note et stylo avec boîte cadeau
PU, metallo, cartone | PU, metal, cardboard | PU, metal, cartón | PU, métal, carton

14,5 x 1,5 x 21 cm 5,5 x 5,5 cm 40

BUSINESS *block notes*



40167 *vallentuna*

Block notes A5 con 30 pagine bianche | Notebook A5 with 30 white pages | Cuaderno A5 con 30 páginas blancas | Bloc notes A5 avec 30 pages blanches

Cartone, carta 70gr | Kraft, paper 70gr | Cartón, papel 70gr | Carton, papier 70gr

14,5 x 21 cm 5,5 x 5,5 cm 120

Business
359



.00

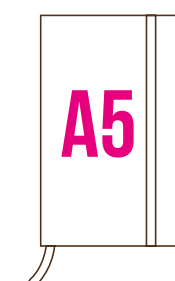

40274 *koncis*

Block notes A5 con copertina rigida. 100 pagine | A5 notebook with rigid cover. 100 pages | Libreta A5 de tapa dura. 100 páginas | Bloc notes format A5 avec couverture rigide. 100pages

Carta riciclata | Recycled Cardboard | Papel reciclado | Papier recyclé

14,7 x 21 x 1,5 cm 5,5 x 5,5 cm 50

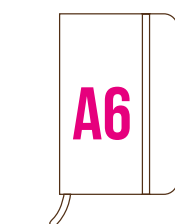

40275 *korken*

Block notes A6 con copertina rigida. 100 pagine | A6 notebook with rigid cover. 100 pages | Libreta A6 de tapa dura. 100 páginas | Bloc notes format A6 avec couverture rigide. 100pages

Carta riciclata | Recycled Cardboard | Papel reciclado | Papier recyclé

9,5 x 14,5 x 1,5 cm 5,5 x 5,5 cm 100



40168 *vandring*

Block notes A5 con spirale. 80 pagine con copertina colorata | A5 spiral notebook with coloured cover. 80 pages. | Libreta A5 de gusanillo con tapa de color. 80 páginas | Bloc notes A5 avec spirale. 80 pages avec couverture colorée
Cartone, carta 70gr | Kraft, paper 70gr | Cartón, papel 70gr | Carton, papier 70gr

15,5 x 21 cm S65 6 x 6 cm 50

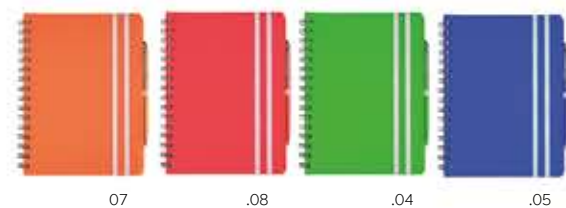

40180 *tillsluta*

Block notes A5 con spirale | A5 spiral notebook | Libreta A5 de espiral | Bloc notes A5 avec spirale
PP, carta 70gr | PP, paper 70gr | PP, papel 70gr | PP, papier 70gr

17 x 21,5 x 1 cm S65 6 x 6 cm 50



40237 *beck*

Block notes con penna. 60 fogli | Ball pen with notebook. 60 sheets | Libreta con bolígrafo. 60 hojas | Bloc note avec stylo. 60 feuilles
Carta | Paper | Papel | Papier

7 x 9,5 x 0,7 cm S72 2 x 2 cm 50/200



40066 *pacu*

Block-notes con penna a sfera, clip pieghevole. Refil blu | Block-notes with ballpoint pen | Bloc con tamaño de tarjeta de crédito y bolígrafo. Refil azul | Bloc-notes avec stylo à bille, agrafe pliable. Refil bleu
Plastica | Plastic | Plástico | Plastique

11,3 x 7,4 x 1,9 cm S72 3 x 2 cm 50/200

BLOCK *notes*

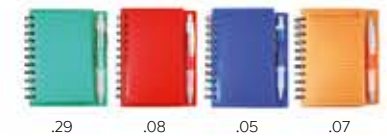

29023 *muraco*

Block-notes spirale con biro, copertina trasparente | Lined note pad supplied with ballpen | Libreta de notas de plástico y bolígrafo | Bloc-notes à spirale avec stylo, couverture transparente
Plastica | Plastic | Plástico | Plastique

14,5 x 2 x 15,9 cm S65 I T4 4 x 4 cm 25/50

.19
.08
.06
.07
.18
.17



40084 *feddo*

Block Notes con 30 fogli | Notepad (30 sheets) | Bloc notas con 30 hojas | Bloc notes avec 30 feuilles
Carta | Paper | Papel | Papier

6,5 x 10 cm S1 4 x 4 cm 40/560



.02

.17



.08

.02

40013 *neta*

Block-notes, con penna | Block-notes with pen | Bloc de notas con bolígrafo | Bloc-notes, avec stylo
Plastica | Plastic | Plástico | Plastique

8 x 10,5 x 1 cm T6 | UV9 3,5 x 3,5 cm 50/200



.04

.08

.21

40012 *paya*

Block-notes con lente d'ingrandimento, stick note e penna a sfera. | Block-notes with magnifier, sticky notes and ballpen in plastic case | Bloc de notas con bolígrafo y lupa. | Bloc-notes avec lentille d'agrandissement, stick note et stylo à bille.

Plastica, carta | Plastic, paper | Plástico, papel | Plastique, papier

6,5 x 11,1 x 1,5 cm T7 | UV17 5 x 3 cm 50/200

office BUSINESS



.02

29134 *yas*

Gomma da cancellare | Eraser | Borrador | Gomme
Gomma | Rubber | Goma | Gomme

5,5 x 2,2 x 1,2 cm UV1 5 x 2 cm DP12 4 x 6,8 cm
25/2000



.02

.23

.08

29225 *crystallo*

Gomma per cancellare. | Rubber | Goma | Gomme
Plastica | Plastic | Plástico | Plastique

T23 | UV2 2 x 1 cm 50/300



.23



.02



.04



.08

40152 *canapa*

Block notes, 40 fogli bianchi | Notepad with 40 recycled plain sheets | Bloc de notas, 40 hojas blancas | Carnet avec 40 feuilles sans lignes
PP

7 x 8 cm S2 3 x 3 cm 20/100

6,5 x 11,1 x 1,5 cm T7 | UV17 5 x 3 cm 50/200



89002 *ndombe*

Lampada da lettura, 1 led | Lamp 1 led | Lampara, 1 led
| Lampe 1 led
Plastica | Plastic | Plástico | Plastique

10 x 9,5 x 4 cm ●● T8 2,5 x 1 cm 50 / 400



89014 *el mirage*

Luce con pinza. Batterie incluse | Lamp, batteries
included | Linterna (Pilas incluidas) | Lampe (piles incluses)
Plastica | Plastic | Plástico | Plastique

25 x 3 x 2 cm ●● T7 2 x 1 cm 200



86021 *moldova*

Clip porta memo | Memo clip | Clip memo | Clip mémo
Metallo | Metal | Metal | Métal

3,6 x 5,5 x 1 cm ●● T6 2 x 1 cm 500/1000



29070 *noe*

Rendiresto per stampa digitale | Changer for digital printing | Bandeja para
la cuenta opcion de personalización digital | Rembourseur pour imprimerie
digitale

Plastica | Plastic | Plástico | Plastique

20,5 x 17 x 1 cm ●● DP4 15,4 x 15,4 cm 50



29161 *wale*

Dispenser per nastro adesivo | Adhesive tape dispenser. istribuidor de
cinta adhesiva | Distributeur de ruban adhésif
Plastica | Plastic | Plástico | Plastique

10 x 5,8 x 4 cm ●● T8 | UV17 3 x 2 cm 10/50



29101 *wapi*

Pinzatrice ecologica senza punti | Ecologic stapler | Grapadora ecologica |
Agrafeuse écologique sans agrafes
Plastica | Plastic | Plástico | Plastique

6 x 5,5 x 5,5 cm ●● T7 | UV3 3 x 1,5 cm 24/288



29198 *hobart*

Pinze portamemo | Office magnet | Imán de oficina | Aimant pour
articles de bureau
Metallo, plastica | Metal, plastic | Metal, plástico | Aimant, plastique

9 x 7 x 2,4 cm ●● T8 3 x 2 cm 25/50

96050 taiga

Righello 30 cm | Ruler 30 cm | Regla 30 cm | Règle 30 cm
Plastica | Plastic | Plástico | Plastique

31 x 3,5 cm UV9 28 x 15 cm | S2 25 x 1 cm | T23 6 x 1,5 cm
25/500

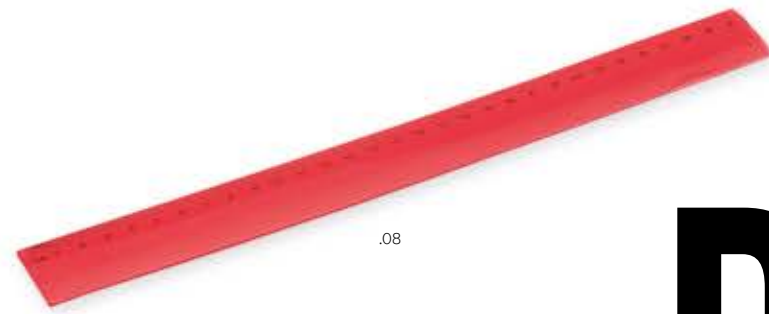

.08

RULERS



.07



.06



.08



.18



.19



.04



.02



.01



.32

81788 lucenas

Righello | Five scale meter | Escalímetro | Regle
Alluminio | Aluminium | Aluminio | Aluminium

30 cm UV7 5 x 0,5 cm 20/200

96095 metairie

Righello 30 cm | Ruler 30 cm | Regla 30 cm | Règle 30 cm
Plastica | Plastic | Plástico | Plastique

30 x 3 cm UV9 28 x 15 cm | S2 25 x 1 cm | T23 6 x 1,5 cm
100/1000

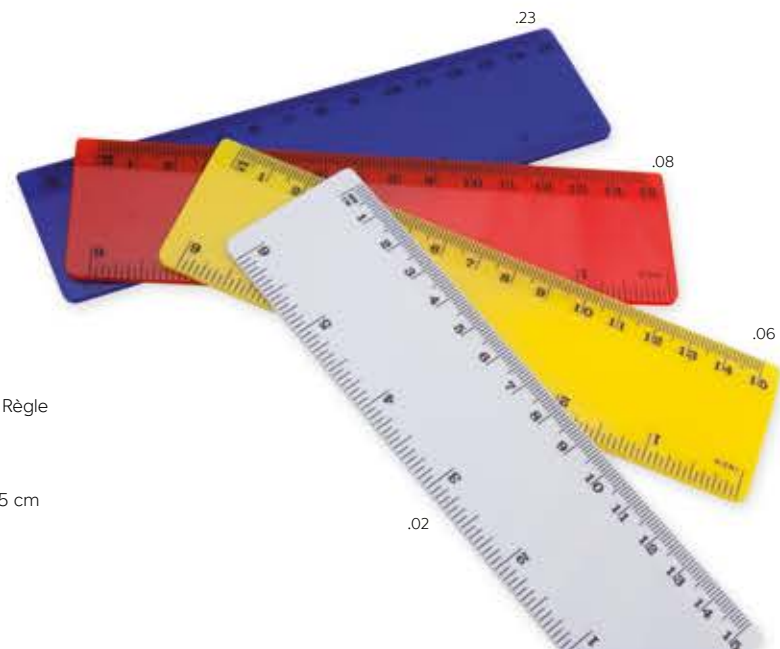

.23

.08

.06

.02

96839 gali

Righelli colorati. 15 cm. | Coloured ruler 15 cm | Reglas de color 15 cm | Règle de couleur. 15 cm
Plastica | Plastic | Plástico | Plastique

16 x 4,2 x 0,2 cm UV2 1,5 x 2 cm | T23 6 x 1,5 cm | S2 10 x 1,5 cm
100/1000



.21

96058 payat

Righello apribuste con lente | Letter opener with ruler and magnifier |
Regla abrecartas con lupa | Règle ouvre-lettre avec lentille
Plastica | Plastic | Plástico | Plastique

8,5 x 5,5 cm UV3 | S3 4 x 1 cm 50/1000



.21

96054 nodin

Righello con lente d'ingrandimento | ruler with magnifier | Regla con lente |
Règle avec lentille d'agrandissement
Plastica | Plastic | Plástico | Plastique

18,5 x 4,5 x 0,3 cm UV3 12 x 2 cm | S3 12 x 2 cm 50/1000

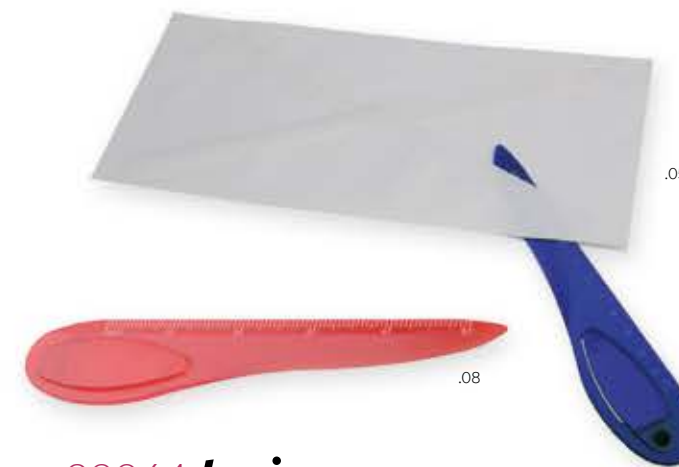

.05

.08

29064 tupi

Righello 12 cm, apribuste e segnalibro con calamita sul retro. | Letter
opener with ruler | Regla 12 cm, abridor de cartas y marcador |
Règle 12cm, ouvre lettre et marque-pages avec aimant sur le verso
Plastica | Plastic | Plástico | Plastique

16,5 x 3,3 x 0,3 cm UV6 | UV1 4 x 1 cm 100/2000



.01



.05

29026 telu

Apribuste | Letter opener | Abrecartas | Ouvre lettre
Plastica | Plastic | Plástico | Plastique

7 x 5,5 x 0,4 cm UV6 | UV2 4 x 1,2 cm 100/1000



.08

.04

29010 ska

Pinza porta memo cubetto trasparente | Cube memo holder | Pinza
portanotas | Pince porte mémo en cube transparent
Plastica | Plastic | Plástico | Plastique

2,5 x 2,5 x 12 cm UV6 | UV1 2 x 2 cm 50/300



29985 *exeter*

Fermacarte in confezione regalo | Paper weight in gift box | Pisapapeles en caja regalo | Grammage du papier en paquet cadeau
Vetro | Glass | Vidrio | Verre

11,5 x 3 x 5 cm S28 | 3D2 | UV18 5 x 3 cm 1/20



29029 *shuma*

Porta CD chiusura con zip, 24 tasche | Wheel shaped CD holder, 24 CDs | Porta CD's en forma de rueda con capacidad para 24 CD's | Porte CD fermeture éclair, 24 poches
Plastica | Plastic | Plástico | Plastique

Ø 15,5 x 5 cm S3 Ø 2,5 cm 1/60



29031 *mumu*

Porta CD, quadrato, per 24 CD | Squared CD holder, 24 CDs | Porta CD, cuadrado, por 24 Cd | Porte CD, carré, pour 24 CD
Similpelle | Imitation Leather | Polipieli | Similicuir

16 x 16 x 4,5 cm S95 7 x 7 cm 50/100



29233 *kaavi*

Mappamondo | World | Bola del mundo | Mappede monde
Vetro | Crystal | Vidrio | Crystal

Base 7 x 1,3 x 7 cm | Globe Ø 8 cm S28 | 3D2 | UV18 5 x 1 cm 1/20

29434 *sale*

Mappamondo 3D in confezione regalo | 3D globe in gift box | Globo 3D con caja regalo | Mappede monde 3d en confection cadeau
Vetro | Glass | Vidrio | Verre

Ø 6 x 10 cm S28 | 3D2 | UV18 2 x 2 cm 1/20



29032 *kano*

Porta CD chiusura con zip, 12 tasche | CD holder which holds 12 CD's | Porta CD's con capacidad para 12 CD's | Porte CD fermeture éclair, 12 poches
Similpelle | Imitation Leather | Polipieli | Similicuir

15 x 16 x 2,5 cm S95 7 x 7 cm 50/100



29037 *tasinka*

Porta CD per parasole auto, 12 tasche | Car sun visor CD holder, 12 CDs | Porta CD's para 12 CD's. Ideal para la visera del coche | Porte CD pour parasol auto, 12 poches
Non-woven

32 x 15,8 x 0,5 cm S95 4 x 4 cm 1/100



29085 *ali*

Porta CD, 10 tasche | CD holder, 10 CDs | Porta CD's con capacidad para 10 CD's | Porte CD, 10 poches
Metallo | Metal | Metal | Métal

Ø 14,5 x 2,2 cm S3 | L13 5 x 2 cm 24/72



40061 oanko

Block-notes in box | Sticky notes sheets in imitation | Bloc de notas en caja | Bloc-notes dans carton

Similpelle, carta | Imitation leather, paper | Polipiel, papel | Similcuir, papier

9,3 x 9,3 x 2,5 cm S3 | DP3 4 x 4 cm 60/120



29345 beaver

Portamemo da 200 Fogli e 125 memo adesivi | 200 sheet paper holder and 125 adhesive memos | Portapapel de 200 hojas y 125 notas adhesivas | Porte-papier de 200 feuilles et 125 mémos adhésifs

Carta | Paper | Papel | Papper

8 x 2,9 x 8 cm S3 4 x 4 cm 50 / 100



29224 veskovo

Portapenne con stick note e notes | Penholder | Penholder | Porte stylos avec stick note et notes

Plastica | Plastic | Plastico | Plastique

11 x 10,5 x 10,5 cm S96 4 x 4 cm 100

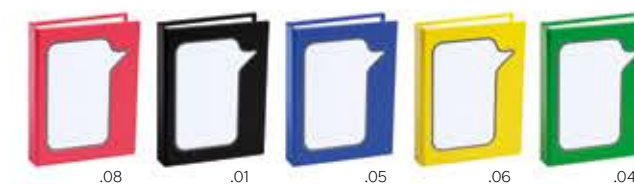

29325 bestående

Block notes con 100 memo stick da 7 x 9 cm, 25 memo stick da 5 x 7,6 cm e 125 mini memo stick da 1,2 x 4,9 cm | 100 Sticky Notes 7 x 9 cm, 25 Sticky Notes 5 x 7,6 cm, 125 Mini Sticky Notes 1,2 x 4,9 cm, | Bloc con 100 memo sticks de 7 x 9 cm, 25 memo sticks de 5 x 7,6 cm y 125 mini memo sticks de 1,2 x 4,9 cm | Bloc notes avec 100 mémos stick (7 x 9cm), 25 memo stick (5 x 7,6cm) et 125 mini memo stick (1,2 x 4,9cm)

Carta riciclata | Recycled Cardboard | Papel reciclado | Papier recyclé

8 x 10,9 x 1,8 cm S3

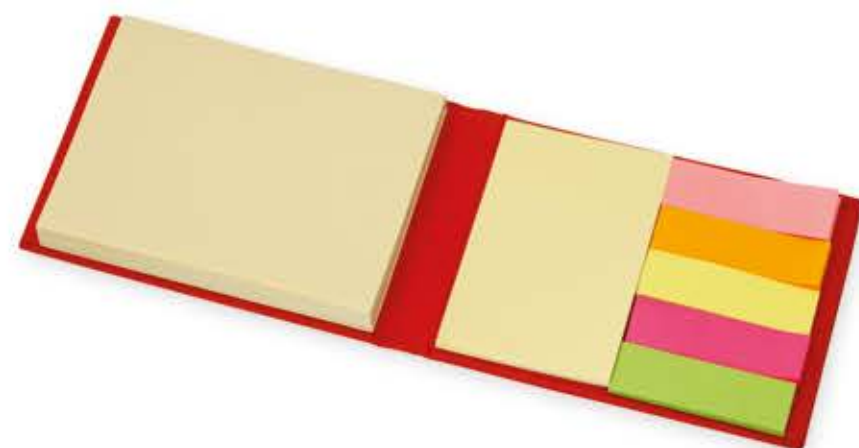

29138 una

Block-notes con memo stick | Block-notes with sticky notes | Bloc Notas con notas adhesivas | Bloc-notes avec memo stick

Carta riciclata | Recycled paper | Cartón Reciclado | Papier recyclé

10,5 x 8 cm T6 6 x 4 cm 25/100

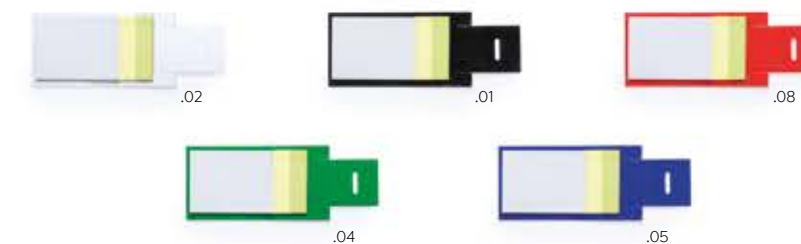

29327 gosig

Block notes con 30 memo stick da 4,5 x 6 cm e 50 mini memo stick da 1,2 x 4,5 cm | Set with 30 sticky notes 4,5 x 6 cm and 50 mini sticky notes 1,2 x 4,5 cm | 30 Notas Adhesivas 4,5 x 6 cm, 50 Mini Notas Adhesivas 1,2 x 4,5 cm, | Bloc notes avec 30 mémo stick (4,5 x 6cm) et 50 mini mémo stick (1,2 x 4,5cm)

Carta riciclata | Recycled Cardboard | Papel reciclado | Papper recyclé

5,4 x 10 x 6,5 cm T7



SUMMER

enjoy the **SUN**!

Occhiali da sole, giochi da spiaggia, ombrelloni e sedie sdraio.
Borse da mare, set con stuoie e ciabatte, ventagli e borse frigo.
Materassini e cuscini gonfiabili, cappelli e molto altro ...

372 - 421

estate - summertime - verano - été



56037 *utforska*

Occhiali da sole UV400 | Sunglasses UV400 | Gafas de sol UV400 | Lunettes de soleil UV400
Plastica | Plastic | Plástico | Plastique

14,5 x 5,1 cm T31 | T32 4 x 0,7 cm 300



57019 *garlago*

Occhiali da sole con lenti a specchio. | Sunglasses with UV 400 protection. Mirror effect lenses. | Gafas de sol con protección UV 400 y lentes efecto espejo. | Lunettes transparentes avec verres réfléchissants.
Plastica | Plastic | Plástico | Plastique

15 x 15 x 4,5 cm T31 | T32 4,5 x 0,7 cm 12/360

SUN *glasses*



.05

Summer
374



.24



.17



.18



.08



.02



.19



.01



.07



.00



.04



.06

56020 *tiepo*

Occhiali da sole (protezione UV 400) | Sunglasses with UV 400 protection | Gafas de sol con protección UV 400 | Lunettes de soleil avec protection UV 400
Plastica | Plastic | Plástico | Plastique

15 x 16,5 x 4 cm T19 | T22 4,5 x 0,7 cm 12/300



Show your
COOL
NESS



.21



57125 *jansjö*

Occhiali da sole con protezione UV400 | Sunglasses with UV400 | Gafas de sol con protección UV400 | Lunettes de soleil avec protection UV400
Plastica | Plastic | Plástico | Plastique

15 x 16,5 x 4 cm T19 | T22 4,5 x 0,7 cm 300



.02

56009 *klagenfurt*

Occhiali con lente a specchio. Protezione UV400 | Sunglasses with mirror effect lenses. UV400 Protection | Gafas de sol con lentes efecto espejo. Protección UV400 | Lunettes à effet miroir. Protection UV400
Plastica | Plastic | Plástico | Plastique

15 x 16,5 x 4 cm T31 | T32 4,5 x 0,7 cm 12/360



.08



56035 *zari*

Occhiali da sole bimbo con protezione UV 400 | Sunglasses with UV 400 protection | Gafas de sol con protección UV 400 | Lunettes de soleil avec protection UV 400
Plastica | Plastic | Plástico | Plastique

13 x 14 x 3 cm T19 | T22 3 x 0,6 cm 10/400



56039 *lunda*

Occhiali da sole UV400 | Sunglasses UV400 | Gafas de sol UV400 | Lunettes de soleil UV400
Plastica | Plastic | Plástico | Plastique

15 x 16,5 x 4 cm T31 | T32 4 x 0,7 cm 300



.06



56036 *cecil*

Occhiali da sole con protezione UV400 | Sunglasses with UV 400 protection | Gafas de sol con protección UV 400 | Lunettes de soleil avec protection UV 400
Plastica | Plastic | Plástico | Plastique

15 x 16,5 x 4 cm T31 | T32 4,5 x 0,7 cm 12/300



.01

.05

56040 *mave*

Occhiali da sole bimbo con protezione UV 400 | Kids sunglasses, with UV 400 protection | Gafas de sol para niños con protección UV 400 | Lunettes de soleil (protection UV 400)
Plastica | Plastic | Plástico | Plastique

13 x 13,5 x 3 cm T19 | T22 3 x 0,7 cm 12/300



.08

56060 *male*

Occhiali da sole bambino | Kids sunglasses | Gafas de sol niño | Lunettes de soleil
Plastica | Plastic | Plástico | Plastique

3 x 13 x 3 cm T19 | T22 3 x 0,7 cm 12/300



.05



.08 .06 .02 .17 .01

56031 patagonia

Occhiali da sole pieghevoli | Sunglasses | Gafas de sol | Lunettes de soleil
Plastica | Plastic | Plástico | Plastique

15 x 16,5 x 4 cm T19 4,5 x 0,7 cm 12/300



.19



.07 .05 .08

56079 ciclaminò

Occhiali da sole con protezione UV400 | Sunglasses with UV 400 protection
| Gafas de sol con protecci3n UV 400 | Lunettes de soleil avec protection
UV 400

Plastica | Plastic | Plástico | Plastique

15 x 16,5 x 4 cm T31 | T32 4,5 x 0,7 cm 10/300

56027 morenci

Occhiali da sole | Sunglasses | Gafas de sol | Lunettes de soleil
Plastica | Plastic | Plástico | Plastique

15 x 16,5 x 4 cm T31 | T32 4,5 x 0,7 cm 12/300



.06 .04



.17 .08



.05



.04 .00 .23
.17 .07

56011 bresle

Occhiali da sole con protezione UV400 | Sunglasses with UV400 protection
| Gafas de sol con protecci3n UV400 | Lunettes de soleil protection UV400
Plastica | Plastic | Plástico | Plastique

15 x 16,5 x 4 cm T31 | T32 4,5 x 0,7 cm 10/300



.01



.08

41114 salekhard

Custodia per occhiali | Sunglasses pouch | Funda gafas | Pochette per
lunetas
Non-woven 80 gr/m² | Non-woven 80 gr/m² | Non-woven 80 gr/m² | Non-
woven 80 gr/m²

9 x 20 cm S2 5 x 10 cm 100/200



.01

57020 mig

Occhiali da sole con protezione UV 400 | Sunglasses with UV 400 protection | Gafas de sol con protección UV 400 | Lunettes de soleil avec protection UV 400

Plastica | Plastic | Plástico | Plastique

15 x 16,5 x 4 cm T19 | T22 3 x 1 cm 12/300



.06



.05

.02

.08

56032 tacna

Occhiali da sole (protezione UV 400) | Sunglasses with UV 400 protection | Gafas de sol con protección UV 400 | Lunettes de soleil avec protection UV 400

Plastica | Plastic | Plástico | Plastique

15 x 16,5 x 3,5 cm T19 | T22 3 x 0,8 cm 10/300



.11

.13

56016 carson

Occhiali da sole con protezione UV400 | Sunglasses with UV400 protection | Gafas de sol con protección UV400 | Lunettes de soleil protection UV400

Plastica | Plastic | Plástico | Plastique

15 x 16,5 x 4,8 cm T19 | T22 4,5 x 0,7 cm 10/300



.23



.08

.00

56041 lac

Occhiali da sole UV400 | Sunglasses UV400 | Gafas de sol UV400 | Lunettes de soleil UV400

Plastica | Plastic | Plástico | Plastique

14,5 x 5,1 cm T31 | T32 4 x 0,7 cm 300



.21

glow in the dark

56019 emerald

Occhiali da sole fluorescenti (si illuminano al buio) | Sunglass glow in the dark. Gafas de sol que brillan en la oscuridad | Lunette de soleil fluorescente (qui s'illuminent à l'obscurité)

Plastique | Plastic | Plástico | Plastique

15 x 16,5 x 4,8 cm T19 | T22 4,5 x 0,7 cm 10/300



.01

.05

.06

.08

57121 sonti

Laccetto per occhiali | Glasses strap | Cinta para gafas | Sangle pour lunettes

Neoprene

2,5 x 35 x 0,4 cm S2 7 x 0,8 cm 20/1000



.02

ITALY



.06 SPAIN



.05 FRANCE

56107 guaro

Occhiale da sole con protezione UV400 | Sunglasses with UV400 protection | Gafas de sol con protección UV 400 | Lunettes de soleil protection UV400

Plastica | Plastic | Plástico | Plastique

15 x 16,5 x 4 cm T19 | T22 4,5 x 0,7 cm 12/300



FOOT & VOLLEY ball



.45

50172 *sonni*

Pallone da calcio | Football ball | Balón de fútbol | Ballon de soccer
PVC, PU

Size 5 T10 3 x 3 cm 1/60



.40



.48



.02

50106 *alumine*

Porta gonfiabile. Piegato per la stampa | Inflatable goal post. Special Folded for Printing | Porteria inflable. Plegado Especial para Impresión | Cage de buts gonflable. Pliéé Spécial pour Impression
PVC | PVC | PVC | PVC

126 x 72 x 50 cm5 S24 20 x 7 cm 20"



.02

50160 *ani*

Pallone da calcio | Football ball | Balón de fútbol | Ballon de soccer
PVC, PU

Size 5 T10 3 x 3 cm 1/60



.45

50007 *kandava*

Pallone da volley | Volleyball Ball | Balon de voleibol | Ballon de volley
PVC, PU

Size 5 T10 6 x 3,5 cm 1/45

FRISBEE



50085 *downi*

Frisbee rigido | Plastic frisbee bended at the edge | Friesbe rígido | Frisbee rigide

Plastica PP | Plastic PP | Plástico PP | Plastique PP

☞ Ø 23 cm ☞ S95 | UV13 Ø 10 cm ☞ 100/300



50091 *wort*

Frisbee gonfiabile | Inflatable frisbee | Frisbee hinchable | Frisbee gonflable PVC

☞ Ø 25 cm ☞ S5 | TR4 Ø 8 cm ☞ 10/250

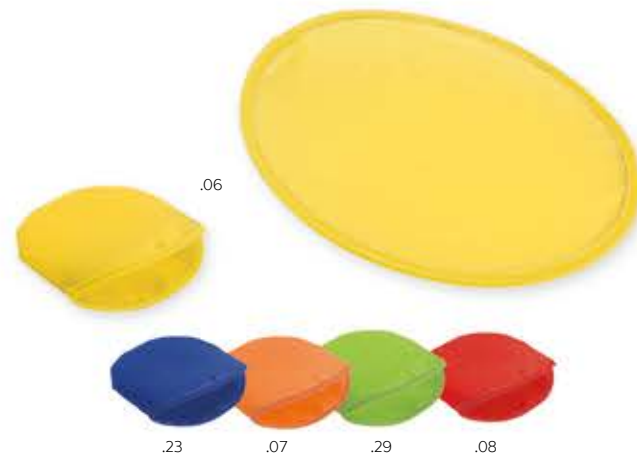

50077 *flinger*

Frisbee pieghevole in pochette | Foldable frisbee, supplied in pouch | Frisbee piegabile en funda | Frisbee pliable dans pochette Nylon

☞ Ø 25 cm ☞ S96 | T3 Ø 16 cm ☞ 50/500



BEACH *racket*



50061 *steve*

Gioco racchette da spiaggia con pallina | Beach racket game | Juego palas de playa | Jeu de raquettes de plage avec balle Legno | Wooden | Madera | Bois

☞ 23,5 x 39 cm ☞ S12 | UV14 Ø 15 cm ☞ 1/24



50056 *jacob*

Gioco racchette da spiaggia con pallina | Beach racket game | Juego palas de playa | Jeu de raquettes de plage avec balle Legno | Wooden | Madera | Bois

☞ 19 x 33 cm ☞ S12 | UV14 Ø 15 cm ☞ 1/24



.08



.01

.05

.04

.06

51782 *backig*

Sedia pieghevole con borsa | Foldable chair with bag | Silla plegable con bolsa | Chaise pliable avec sac
Poliestere | Polyester | Poliéster | Polyester

▣ 54 x 70 x 45 cm ♻️ S16

Summer
386



.05



.07

.18

.08

51767 *katano*

Sedia pieghevole superleggera | Ultra light folding chair | Silla plegable ultra ligera | Chaise pliable ultra-légère
Poliestere 600D | Polyester 600D | Poliéster 600D | Polyester 600D

▣ 47 x 50 x 24 cm ♻️ S16 10 x 10 cm 📦 6



.01

.23

.08

51096 *gredir*

Sedile con borsa termica | Cooler bag chair | Asiento con bolsa isotérmica | Chaise avec sac thermique
Poliestere 600D | Polyester 600D | Poliéster 600D | Polyester 600D

▣ 35 x 26 x 32 cm ♻️ S16 8 x 8 cm 📦 1/20



.05



.08



.04



.01

51764 *bangalore*

Sedia pieghevole con cuscino | Folding chair with pillow | Silla plegable con cojín | Chaise pliable. Coussin inclu
Poliestere 600D | Polyester 600D | Poliéster 600D | Polyester 600D

▣ 47 x 60 x 62 cm ♻️ S16 10 x 10 cm 📦 6



.04



52007 *sonke*

Braccialetto con chiusura di sicurezza | Adjustable fastening bracelet
| Pulsera con cerradura de seguridad | Bracelet avec fermeture de sécurité

Non-woven

26 x 2,5 cm S1 10 x 1 cm 100/5000



.07



52002 *eric*

Braccialetto con chiusura di sicurezza | Adjustable fastening bracelet
| Pulsera con cerradura de seguridad | Bracelet avec fermeture de sécurité

Plastica | Plastic | Plástico | Plastique

24,3 x 2 cm S2 7 x 1,5 cm 100/5000



.07



41017 *nellig*

Misuratore Raggi UV | UV-Rays indicator bracelet | Medidor Rayos UV
Mètre pour rayon UV

20,2 x 2,5 cm S2 3 x 1 cm 200/2000



.08



13008 *aneris*

Cuffia piscina | Swimming cap | Gorro piscina | Bonnet de bain
Spantex

21,5 x 14 cm S9 | SP39 (only white colour) 7 x 3 cm 50/400



.06



41123 *gamalero*

Pochette | Beauty case | Neceser | Pochette
PVC | PVC | PVC | PVC

25 x 23 x 5 cm S8 13 x 10 cm 50/200



.04



50083 *sosny*

Portaoggetti impermeabile | Waterproof beach purse with head string | Bolsito
impermeable | Porte objets imperméable
PVC

23 x 9,5 cm S2 5 x 5 cm 50/500





59007 *rappi*

Posacenere da spiaggia | Beach ashtry | Cenicero de playa | Cendrier de plage
Plastica | Plastic | Plástico | Plastique

☞ ∅ 8 cm ☞ T6 ∅ 4 cm ☞ 1/500



59010 *vogue*

Posacenere tascabile | Pocket Ashtray | Cenicero de bolsillo | Cendrier de poche
Plastica | Plastic | Plástico | Plastique

☞ 8 x 8 cm ☞ S2 3 x 3 cm ☞ 10/400



② 50057 *maden*

Ventaglio | Foldable hand fan | Abanico plegable | Éventail
Plastica/legno | Plastic/wooden | Plástico/madera | Plastique/bois

☞ 43 x 23 cm ☞ T7 6 x 1 cm ☞ 1/250



① 50210 *miki*

Ventaglio | Fan | Abanico | Éventail
Plastica | Plastic | Plástico | Plastique

☞ 18 x 24 cm ☞ S95 (10 x 5 cm) | T6 (5 x 0,5 cm) 10 x 5 cm ☞ 100/500

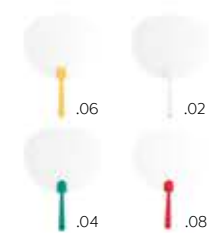

③ 50059 *yuko*

Ventaglio pieghevole | Foldable hand fan | Abanico plegable | Éventail pliable
Carta, plastica | Paper, plastic | Papel, plástico | Plastique, papier

☞ 24 x 26 ☞ T7 5 x 0,8 cm ☞ 100/500

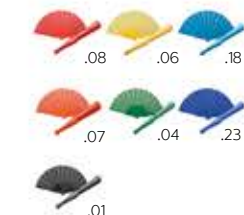

④ 50068 *ramon*

Ventaglio | Foldable hand fan | Abanico | Éventail
Plastica | Plastic | Plástico | Plastique

☞ 41 x 23 cm ☞ T7 6 x 1 cm ☞ 1/250





92820 **huoders**

Ombrellone da spiaggia | Beach umbrella | Sombrilla de playa | Parapluie de plage
Poliestere | Polyester | Poliéster | Polyester

☞ ☞ ☞ Ø 145 x 170 cm ☞ ☞ S34 | SP14 (only white colour) 30 x 5 cm 📦 1/12

92952 **lilo**

Ombrellone da spiaggia | Beach umbrella | Sombrilla de playa | Parapluie de plage
Poliestere | Polyester | Poliéster | Polyester

☞ ☞ ☞ Ø 150 cm ☞ ☞ S34 30 x 5 cm 📦 1/12



50150 **jaime**

Stuoia da mare richiudibile | Beach straw mat with no-woven outside pocket | Esterilla de playa plegable | Nette de plage pliable
Paglia, TNT | Straw, TNT | Paja, TNT | Paille, TNT

☞ ☞ ☞ 175 x 61,5 cm ☞ ☞ S6 10 x 10 cm 📦 1/20

51101 **indals**

Borsa termica | Cooler bag | Nevera | Sac thermique
Polyester 600Dx300D, Aluminium | Polyester 600Dx300D, Aluminium | Poliéster 600Dx300D, Aluminio | Polyester 600Dx300D, Aluminium

☞ ☞ ☞ 39 x 44 cm ☞ ☞ S7 10x10 📦 50



Summer
394

51783 äpplarö

Materassino da spiaggia richiudibile | Foldable beach mat | Esterilla de playa plegable | Matelas gonglable de plage pliable
Non woven 80g | Non woven 80g | Non woven 80g | TNT 80g

70 x 180 cm



.06

.04

.05



.07



.17



.18



.29

50012 riley

Borsa da Spiaggia, ciabatte in gomma e stuoia | Beach straw mat in bag with flip-flop | Bolsa de playa con esterilla y chanclas | Sac de plage, natte, sandales en gomme
Paglia | Straw | Paja | Paille

35 x 30 x 6 cm S7 16 x 6 cm 1/20



.17



.18

64070 hilarion

Borsa da spiaggia con stuoia | Beach straw mat in flowered bag | Bolsa de playa con esterilla de paja | Sac de plage avec natte
Cotone | Cotton | Algodón | Coton

40 x 31,5 x 8 cm S7 5 x 5 cm 1/50



.17



.06



.18

50010 james

Borsa da spiaggia, stuoia, ciabatte in gomma e cappellino | Beach straw mat in bag with flip-flop and straw hat | Conjunto de playa. Incluye una esterilla, chanclas y sombrero en bolsa transparente | Sac de plage, natte, sandales en gomme et chapeau
PVC

34 x 32,7 x 9,4 cm S7 10 x 10 cm 1/36

Summer
395

BEACH *towels*



.07



.05



.08



.19



18059 *amaramba*

Asciugamano sportivo | Sport towel | Toalla deportiva | Serviette
Microfibra 290gr | Microfiber | Microfibra | Microfibre

120 x 60 cm 5 x 5 cm 72

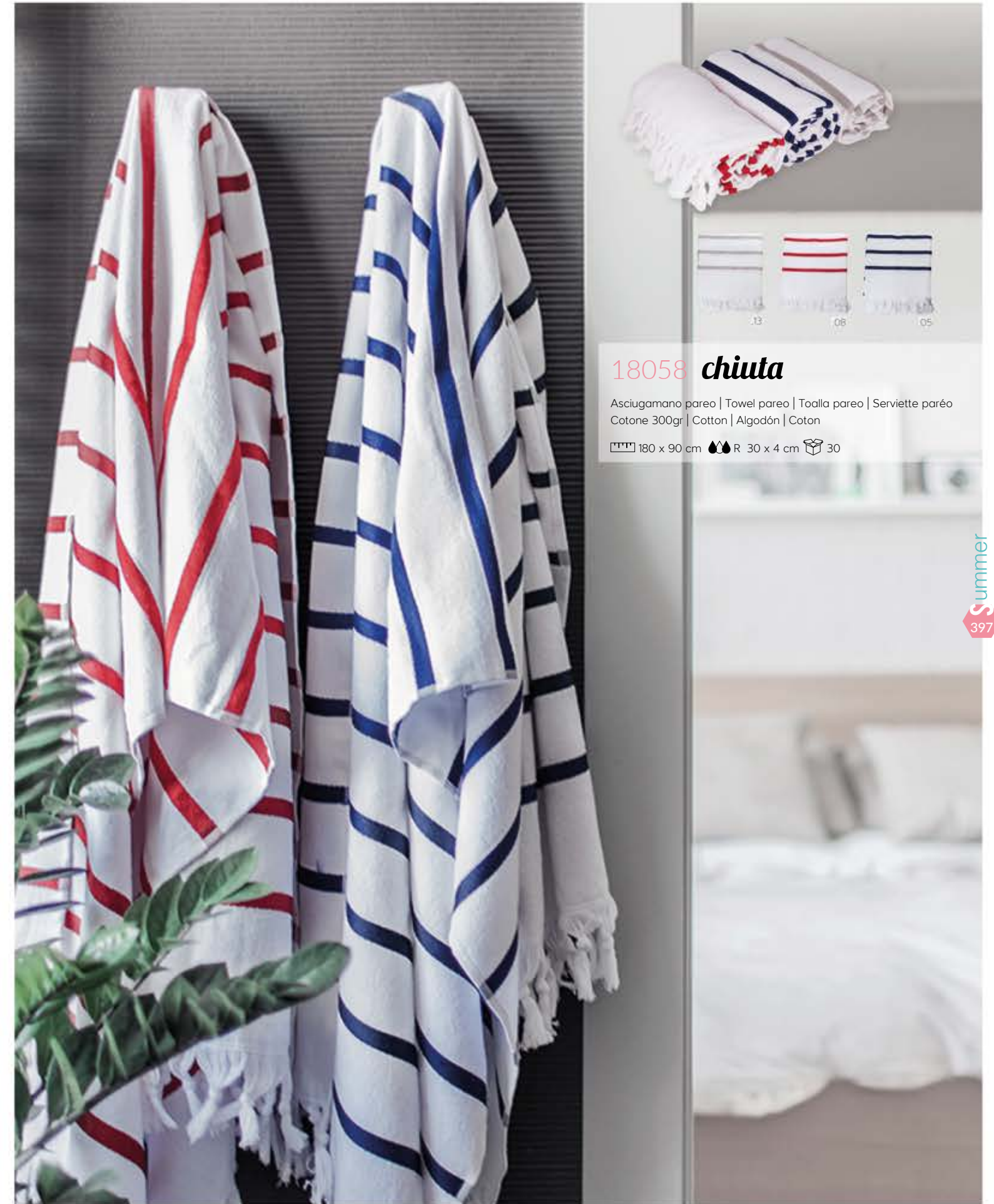

18058 *chiuta*

Asciugamano pareo | Towel pareo | Toalla pareo | Serviette paréo
Cotone 300gr | Cotton | Algodón | Coton

180 x 90 cm R 30 x 4 cm 30



18055 *guglionesi*

Asciugamano da mare | Beach towel | Toalla de playa | Serviette de plage
 Microfibra 250 gr/m² | Microfiber 250 gr/m² | Microfibra 250 gr/m² | Microfibre 250 gr/m²

150 x 75 cm S99 10 x 10 cm 10/20



14612 *digue*

Telo/asciugamano con frangette | Towel with fringes | Toalla pareo con flecos | Serviette avec franges
 Cotone, poliestere | Cotton, polyester | Algodón, poliéster | Coton, polyester

90 x 180 cm S37 30 x 15 cm 25

Summer
398



18031 *plano*

Borsa/asciugamano da spiaggia | Foldable beach towelbag | Bolsa/toalla plegable de playa | Sac/serviette de plage
 Microfibra 160 gr/m² | Microfiber 160 gr/m² | Microfibra 160 gr/m² | Microfibre 169 gr/m²

150 x 70 cm S99 10x10 50



18051 *polen*

Zaino/asciugamano da spiaggia | Foldable beach towelbag | Mochilla/toalla plegable de playa | Sac à dos/serviette de plage
 Microfibra 160 gr/m² | Microfiber 160 gr/m² | Microfibra 160 gr/m² | Microfibre 160 gr/m²

150 x 70 cm S99 10x10 50



14613 *curaçao*

Pareo con frangette | Pareo with fringes | Pareo con flecos | Paréo avec franges
 Cotone 200gr | Cotton 200gr | Algodón 200gr | Coton 200gr

180 x 180 cm S75 30 x 12 cm 20

Summer
399

WATER PROOF bag



.08

.23

.06

17187 *malebo*

Borsa impermeabile | Waterproof bag | Bolsa impermeable | Sac impermeable
Ripstop | Ripstop | Ripstop | Ripstop

26 x Ø 11,5 cm 🚰 S15 10 x 6 cm 📦 10 / 200



.23

.06

.08

17188 *mulenda*

Borsa impermeabile | Waterproof bag | Bolsa impermeable | Sac impermeable
Ripstop | Ripstop | Ripstop | Ripstop

36 x Ø 18,5 cm 🚰 S15 10 x 6 cm 📦 10 / 200

COOLER bag



.06



.06



.07



.17



.02



.01



.08



.04



.05

51150 *mammut*

Zaino termico | Thermic backpack | Mochila termo | Sac à dos thermique
Poliestere 210D, alluminio | Polyester 210D, aluminium | Poliéster 210D, aluminio |
Polyester 210D, aluminium

32 x 42 cm 🚰 S76 📦 200

COOLING *bag*



51781 *fubbla*

Borsa termica | Cooler bag | Nevera portátil | Sac thermique

Non-woven, alluminio | Non-woven, aluminium | Non-woven, Aluminium | Non-woven, aluminium

21 x 15 x 15 cm S35

51160 *mångfald*

Borsa frigo | Cooler bag | Nevera | Sac thermique

Non-woven, alluminio | Non-woven, aluminium | Non-woven, Aluminium | Non-woven, aluminium

27 x 31 x 15 cm T20

51170 *mastholmen*

Borsa frigo imbottita | Padded cooler bag | Nevera acolchada | Sac thermique rembourré

Poliestere 210D | Polyester 210D | Poliester 210D | Polyester 210D

48 x 41 x 11 cm T6



51100 *eppo*

Borsa termica | Cooler bag | Bolsa isotérmica | Sac thermique

Non woven 80gr/m² 32 x 35 x 17 cm S35 | TR5 8 x 8 cm 1/20



51093 *shatzy*

Borsa termica per 6 lattine | Cooler bag for 6 cans | Bolsa isotérmica max 6 latas | Sac thermique pour 6 boites

Nylon 600d 20 x 14 x 13 cm S35 | TR5 8 x 8 cm 10/60

51108 *hilda*

Borsa termica | Cooler bag | Bolsa isotérmica | Sac thermique

Non-woven 20 x 14 x 13 cm S35 | TR5 8 x 8 cm 10/60



.05



51140 *platon*

Borsa termica con tracolla | Cooler bag | Bolsa isotérmica con bandolera regulable | Sac thermique avec bandoulière.
 Poliestere 600D | Polyester 600D | Poliéster 600D | Polyester 600D

25 x 27 x 18 cm S35 | TR5 8 x 8 cm 1/25



.02

51115 *gallese*

Borsa termica per 6 bottiglie | Thermic bag for 6 bottles ! Bolsa termica por 6 botellas ! Sac Thermique
 Poliestere 600D, PVC | Polyester 600D, PVC | Poliéster 600D, PVC | Polyester 600D, PVC

29 x 24 x 20 cm TR5 | SP25 8 x 8 cm 5/10



.08



.05

.07

.29

51094 *ramirez*

Borsa termica con tracolla regolabile | Cooler bag with adjustable strap | Bolsa isotérmica con bandolera regulable | Sac thermique avec bandoulière réglable
 Poliestere 600D | Polyester 600D | Poliéster 600D | Polyester 600D

19 x 10 x 32 cm S35 8 x 8 cm 20/40



.08



.17



.02

.05

.07

.29

.08

.06



.04

.05

.06

51130 *fresko*

Borsa termica | Cooler bag | Bolsa isotérmica | Sac thermique
 Alluminio | Aluminium | Aluminio | Aluminium

32 x 29 x 15 cm S35 20 x 15 cm 1/100

51102 *avre*

Borsa termica | Cooler bag | Nevera | Sac thermique
 Non-Woven Laminato, Alluminio | Laminated Non-Woven, Aluminium | Non-Woven Laminado, Aluminio | Non tissé laminé, Aluminium

34 x 15 x 37 cm S35 20 x 20 cm 50/200



.08



.23

.01

51007 *sapodilla*

Borsa Termica | Cooler Bag | Bolsa térmica | Glacière
 Poliestere 600D, PVC | Polyester 600D, PVC | Poliéster 600D, PVC | Polyester 600D, PVC

25 x 24 x 15 cm S35 10 x 5 cm 20



.19



.23

51009 *cherry*

Zaino termica | Cooler backlook | mochila isotérmica | mas thermique
 Poliestere | Polyester | Poliéster | Polyester

34 x 15 x 40 cm S35 | TR5 10 x 10 cm 30



51008 *pitaya*

Borsa Termica | Cooler Bag | Bolsa térmica | Glacière
PVC

27 x 8 x 21 cm S35 10 x 10 cm 100



51006 *sverker*

Borsa termica | Cooler bag | Bolsa isotérmica | Sac thermique
PVC, Alluminio | PVC, Aluminium | PVC, Aluminium | PVC, Aluminium

15 x 13 x 15 cm S35 8 x 8 cm 200



.05



.08



51118 *oliv*

Portabottiglia termica, capacità 0,5 litri | Single bottle cooler bag | Portabotella isotérmica con apertura para boquilla. Para botellas de 0,5 litros | Porte bouteille thermique, capacité 0,5l
Nylon 70D

23 x 9,5 x 5 cm S35 | TR5 3 x 3 cm 30/120



.07



51123 *peterro*

Porta lattine o bottiglia termico estensibile | Extending cooler bottle holder | Porta lata-botella extensible | Porte boîte ou bouteille thermique extensible

Poliestere | Polyester | Poliéster | Polyester

Ø 8 x 24 cm S35 3 x 3 cm 10/400

51126 *walter*

Portabottiglia termico, con tracolla regolabile e taschino frontale, capacità 1,5 lt | Cooler bag for one bottle, 1.5 lt | Bolsa isotérmica para una botella de 1,50 lt con bolsillo frontal | Porte bouteilles thermique, avec bandoulière réglable, 1,5 lt
Nylon 70 D

Ø 11,5 x 34 cm S35 5 x 5 cm 25/50



.07



51001 *agoy*

Borsa termica per 6 lattine da 0,33 lt | Cooler bag, 6 cans of 0,33lt | Bolsa isotérmica para 6 latas de 0,33 lt | Sac thermique pour 6 boîtes de 0,33 lt
PVC/Alluminio

20 x 15 x 15 cm S35 8 x 8 cm 200



.05



51003 *brividor*

Borsa termica | Cooler bag | Nevera portátil | Glacière
Non-woven, alluminio | Non-woven, aluminium | Non-Woven, aluminio | Non-woven, aluminium

25 x 18 x 11 cm S35 10 x 10 cm 25 / 100



56811 *soffietto*

Ventilatore portatile | Mini ventilator | Ventilador | Ventilateur portatif
Plastica | Plastic | Plástico | Plastique

10 x 10,4 x 3,6 cm T7 3 x 1 cm 50/200



50130 *nestos*

Pistola ad acqua | Water gun | Pistola de agua | Pistolet à eau
Plastica | Plastic | Plástico | Plastique

4,1 x 2,2 x 5,5 cm T6 4 x 1 cm 100/1000



Summer
408



83040 *mula*

Ventilatore con dinamo | Dinamo ventilator | Ventilador de mano dinamo | Ventilateur dinamo
ABS | ABS | ABS | ABS

13,8 x 4 x 3,5 cm T6 2 x 2 cm 50 / 200



56900 *rangoon*

Secchiello con accessori da spiaggia | Beach game set | Juego de playa
| Jeu de plage
Plastica | Plastic | Plástico | Plastique

24 x 28 x 10 cm T9 5 x 5 cm 1/40

Summer
409



56028 *ebert*

Vaporizzatore, 70 ml | Water spray, 70 ml | Vaporizador, 70 ml | Vaporisateur,
70 ml
PVC

21,5 cm Ø 3,2 cm T7 4 x 1 cm 1/100



Summer
410

.23

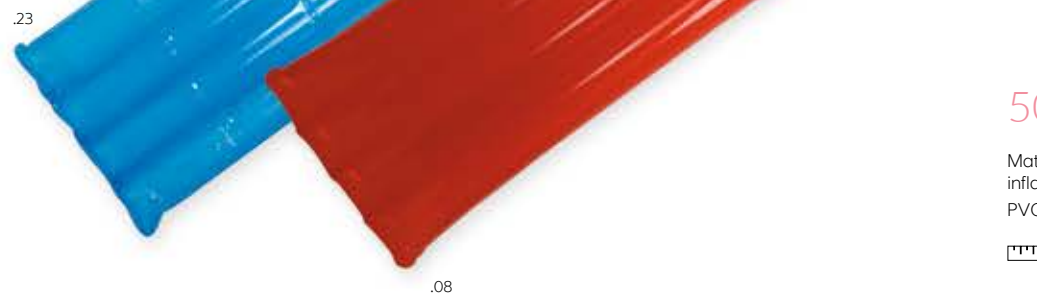

.08



.07



.21

50043 *matrah*

Materassino gonfiabile | Beach mattress | Colchoneta inflable | Matelas gonfiable
PVC

70 x 167 cm S24 30 x 15 cm 30



.07



.23

.08



.07



.19

.23

.08



.05



.08

.07

.21

50039 *flota*

Poltrona gonfiabile | Inflatable chair | Sillón hinchable | Fauteuil gonfiable
PVC

74 x 74 cm S24 15 x 15 cm 30

50079 *dolfuri*

Materassino gonfiabile | Beach mattress | Colchoneta inflable | Petit matelas gonfiable
PVC

41 x 73 cm S24 8 x 5 cm 10/100

50011 *wolly*

Bracciali gonfiabili trasparente/solido | Inflatable armbands | Manguitos hinchables | Bracelet de natation
PVC

15 x 19,5 x 7 cm S12 5 x 5 cm 100



.08

.06

.04

.23

.07

50087 *phil*

Clik-Clack gonfiabili, a coppia | Inflatable clack sticks, 2 pcs | Bastones hinchables, 2 piezas | Batons clic clac gonfiable, à couple
PVC

10 x 60 cm S74 | BO 30 x 5 cm 10/500

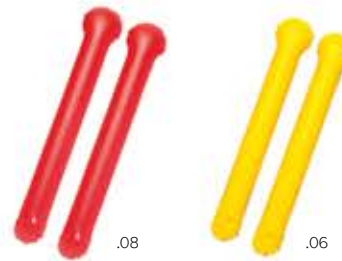

.08

.06

50064 *lisbona*

Clik-Clack gonfiabili, a coppia | Inflatable Clack sticks, 2pcs for pack. | Bastones hinchables, 2 piezas | Batons clic clac gonfiable, à couple
PVC

9,5 x 55 cm S12 | 30 x 5 cm 50/250



.02



.02

50202 *kyle*

Gonfiabile 'tartaruga' | Inflatable 'turtle' | Tortuga hinchable | Tortue gonfiable
PVC

50 cm S5 5 x 5 cm 50/300



.04

Summer
411



50546 *ängland*

Cuscino gonfiabile | Inflatable pillow | Cojín hinchable | Coussin gonflable

PVC

30 x 15 cm 55 15 x 10 cm 100/200



50098 *kipling*

Cuscino gonfiabile | Inflatable pillow | Cojín hinchable | Coussin gonflable

PVC

33 x 18 cm 55 15 x 10 cm 100 / 200

.23

Summer
412



50090 *anfis*

Cuscino gonfiabile | Inflatable pillow | Almohadilla hinchable | Coussin gonflable

PVC

33 x 25 cm 55 15 x 4 cm 1/200

.08

Summer
413



.45



.48

50088 *slash*

Borsa cuscino bicolore gonfiabile | Bag and inflatable pillow | Bolsa y almohadilla hinchable | Sac et oreiller gonfiable

PVC

35 x 30,5 cm 55 10 x 5 cm 10/200



.08



50037 *greve*

Cuscino gonfiabile | Inflatable pillow | Almohadilla hinchable | Oreiller gonfiable

PVC

30 x 30 cm 55 10 x 5 cm 10/200



.08



.04

.07

.06

.05

50547 *bjursta*

Pallone gonfiabile | Beach ball | Balón hinchable | Ballon gonflable
PVC Trasparent/solid color

empty 37 cm 🌊 S5



.05

.04



.06



.08

50071 *record*

Palla da spiaggia gonfiabile | Inflatable beach ball | Pelota de playa hinchable | Balle de plage gonflable
PVC

📏 empty 40 cm 🌊 S5 | TR4 12 x 6 cm 📦 100/200



.02

50060 *diego*

Palla da spiaggia gonfiabile | Inflatable football | Pelota de playa con diseño fútbol | Ballon de plage gonflable
PVC

📏 empty 36 cm 🌊 S5 | TR6 5 x 5 cm 📦 100/400

All beach



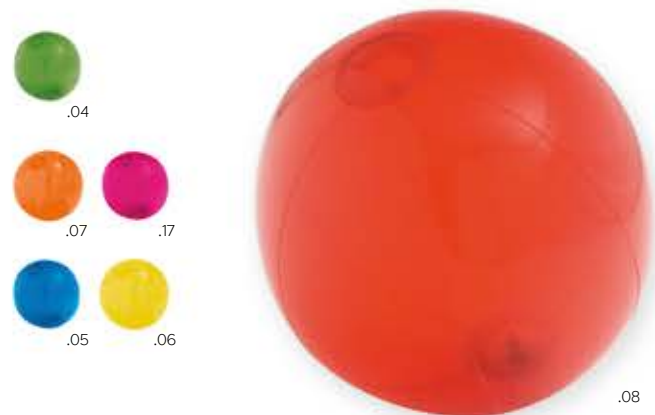

50024 kotka

Palla gonfiabile | Translucent inflatable ball | Balón hinchable | Ballon gonflable
PVC

empty 38 - 40 cm 🌊 S5 | TR6 12 x 6 cm 📦 100/200



50099 tommy

Poltrona portacellulare gonfiabile | Armchair shaped inflatable mobile phone holder | Sopoite móvil | Porte cellulaire en forme de fauteuil gonflable
PVC

12 x 12 cm 🌊 S5 3 x 1 cm 📦 50/500



50065 othon

Mano gonfiabile con valvola | Inflatable Hand with inflating valve | Mano hinchable con válvula | Main gonflable avec valvule
PVC

33 x 57 cm 🌊 S5 5 x 5 cm 📦 1/500

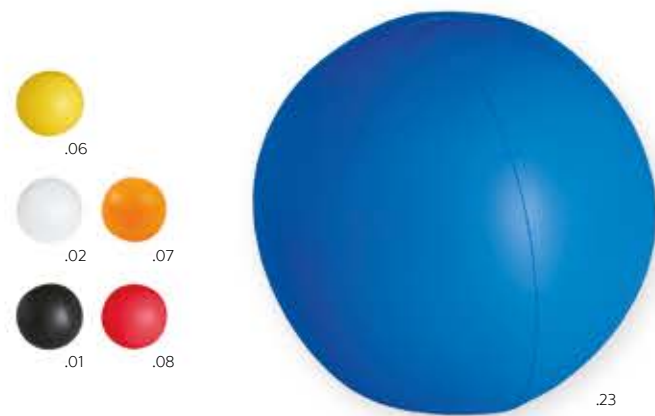

50070 domus

Palla da spiaggia gonfiabile | Inflatable beach ball | Pelota de playa hinchable | Balle de plage gonflable
PVC

empty 40 cm 🌊 S5 | TR4 12 x 6 cm 📦 100/200



50103 sirk

Portaocchiali/cellulare gonfiabile | Glasses or phone inflatable holder | Porta gafas/movil hinchable | Porte lunettes/cellulaire gonflable
PVC

18,5 x 11 cm 🌊 S5 4 x 1 cm 📦 25/500

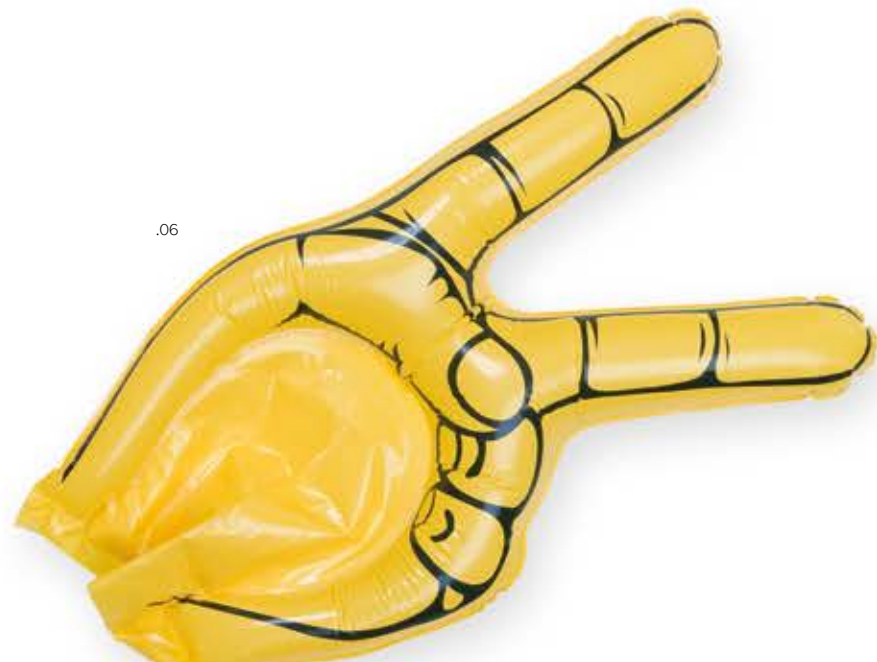

.08



.02

.08

.06

.07

.01

.23

50001 jamie 36/38

50002 jamie 42/44

Infradito da spiaggia in gomma | Flip flop | Chanclas | Sandales de plage en gomme
EVA

size 36/38- 42/44 🌊 S14 5 x 0,7 cm 📦 1/60



50004 erkan

Infradito da spiaggia in gomma misura 39 | Floral flip flop | Chanclas, talla 39 | Sandales de plage en gomme, taille 39
EVA

size 39 🌊 S14 5 x 0,7 cm 📦 1/48





.04



13007 zimmy

Cappello (nastro escluso art. 14001) | Hat (excluded band item 14001) | Sombrero (cinta excluida art. 14001) | Chapeau Poliestere

58 cm 25/100



.08



13016 mulig

Cappello (nastro escluso art. 14001) | Hat (excluded band item 14001) | Gorra (cinta excluida art. 14001) | Chapeau (ruban exclu réf. 14001) Paglia | Straw | Paja | Paille

58 cm 250



13002 musa

Cappellino spiaggia | Straw hat | Sombrero de playa | Chapeau de plage en paille
Paglia | Straw | Paja | Paille

19 x 15,5 x 3 cm S37 5 x 5 cm 50/200

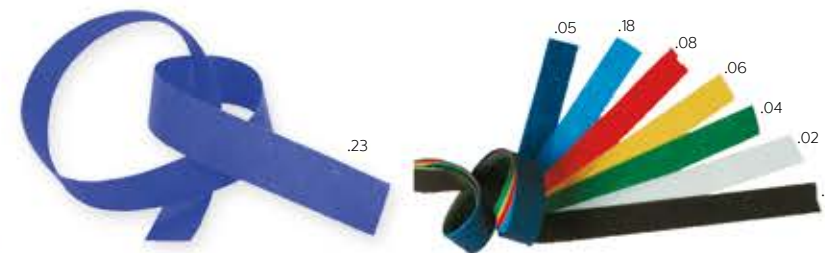

14001 sticky

Nastro per cappello, sombrero fornito separatamente | Hat band sombrero supplied separately | Cinta para sombrero, se entregan separados | Ruban pour le chapeau, sombrero fourni séparément
No Woven TNT

67 x 2,7 cm S36 25 x 1,5 cm 3000



13009 kalk

Cappello (nastro escluso art. 14001) | Hat (excluded band item 14001) | Sombrero (cinta excluida art. 14001) | Chapeau (ruban exclu réf. 14001) Poliestere

58 cm 25/100



13001 trivor

Cappello (ideale per la stampa diretta) | Hat | Sombrero | Chapeau Poliestere

58 cm 25/100



13017 *stiniva*

Cappello | Short brim hat | Sombrero de ala corta | Chapeau
Paglia | Straw | Paja | Paille

58 cm 1/300



13100 *grezzano*

Cappello | Straw Hat. Ribbon not included. | Sombrero de paja.
Banda no incluida. | Chapeau
Paglia | Straw | Paja | Paille

58 cm 1/300

13095 *gisbert*

Cappello (nastro escluso art. 14001) | Hat (excluded band item
14001) | Gorra (cinta excluida art. 14001) | Chapeau (ruban exclu
réf. 14001)
Paglia | Straw | Paja | Paille

58 cm 1/300



13018 *catedrais*

Cappello (nastro escluso art. 14001) | Short brim hat (excluded
band item 14001) | Sombrero de ala corta (cinta excluida art.
14001) | Chapeau (ruban exclu réf. 14001)
Paglia | Straw | Paja | Paille

58 cm 1/300



13101 *appaftig*

Cappello (nastro escluso art. 14001) | Hat (excluded band
item 14001) | Sombrero (cinta excluida art. 14001) | Chapeau
Carta | Paper | Papel | Papier

58 cm 1/300



13000 *gosse*

Cappello (nastro escluso art. 14001) | Hat (excluded band item
14001) | Sombrero (cinta excluida art. 14001) | Chapeau
Paglia | Straw | Paja | Paille

58 cm 1/300

GREENLINE

choose **NATURE**

Matite, penne, quaderni, block notes in materiali ecologici. Borse per la spesa biodegradabili. Segnalibri con foglietti segnapagina, memo stick in carta riciclata e molto altro...

422 - 439

greenline





.13



.00



.13

40167 *vallentuna*

Taccuino 30 fogli | Block-notes with 30 sheets | Libreta 30 hojas | Carnet. 30 feuilles
Carta riciclata | Recycled paper | Papel reciclado | Papier recyclé

14,5 x 21 cm ♻️ S65 5,5 x 5,5 cm 📦 120

20113 *maska*

Matita ecologica | Ecofriendly pencil | Lápiz ecológica | Crayon écologique
Carta riciclata | Recycled paper | Papel reciclado | Papier recyclé

17,5 cm ♻️ T1 | UV1 5 x 0,5 cm 📦 100/2000

40065 *muriel*

Taccuino 30 fogli | Block-notes with 30 sheets | Libreta 30 hojas | Carnet. 30 feuilles
Carta riciclata | Recycled paper | Papel reciclado | Papier recyclé

9,3 x 12,5 cm ♻️ S64 5 x 5 cm 📦 50/100

GERMINATING *Pencil*

L'unica **matita**
che si trasforma
in una pianta!

The first pencil that turns into a plant!
El único lápiz que se transforma en una planta!
Le seul crayon qui se transforme en plante!

Tipologie di semi | The varieties | Tipos de semillas | Types de graines

- .00 Girasole - Sunflower - Girasol - Tournesol
- .01 Basilico - Basil - Albahaca - Basilic
- .02 Calendula - Calendula - Caléndula - Calendula
- .03 Pomodorino - Cherry tomato - Tomates cerises - Tomato-cerise
- .04 Coriandolo - Cilantro - Cilantro - Coriandre
- .05 Pisello odoroso - Sweet pea - Guisante de alor - Pois de senteur
- .06 Nontiscordardime - Forget me not - Nomeolvides - Myosotis
- .07 Peperone - Sweet pepper - Pimiento - Poivre
- .08 Fragola - Strawberry - Fresa - Fraise
- .09 Menta - Mint - Menta - Menthe
- .10 Rosmarino - Rosemary - Romero - Romarin
- .11 Salvia - Sage - Salvia - Sauge
- .12 Timo - Thyme - Tomillo - Thyme
- .24 Peperoncino - Red Cayenne - Chile - Piment



96144 *gantz*

Matita che germoglia | Germinating Pencil | Lápiz con semillas | Crayon avec graines
Legno | Wood | Madera | Bois

19 cm ♻️ T2/L1 5 x 0,5 cm 📦 50/500

96144 Box Box

Carta | Paper | Papel | Papier

20 x 4 cm



ARE YOU LOOKING FOR A...



greenline
426

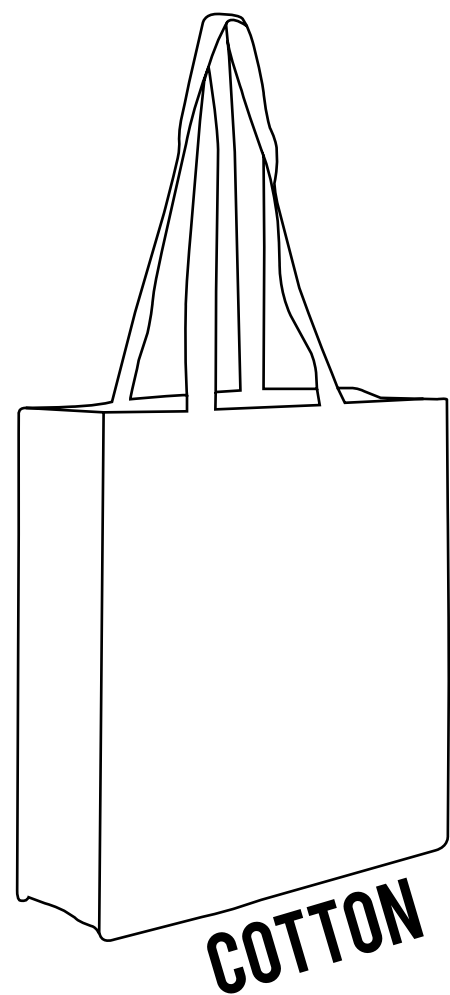

COTTON

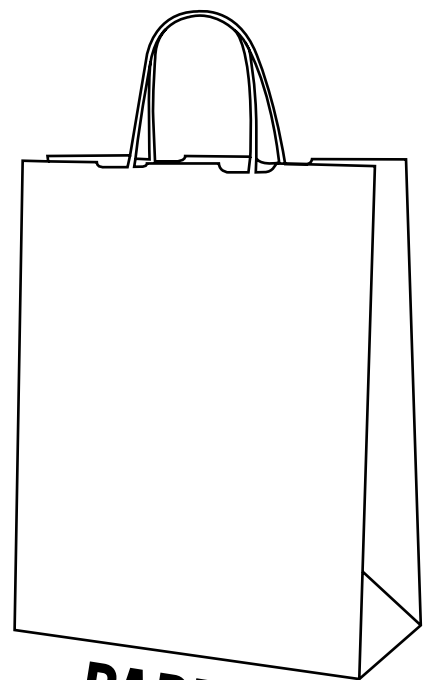

PAPER

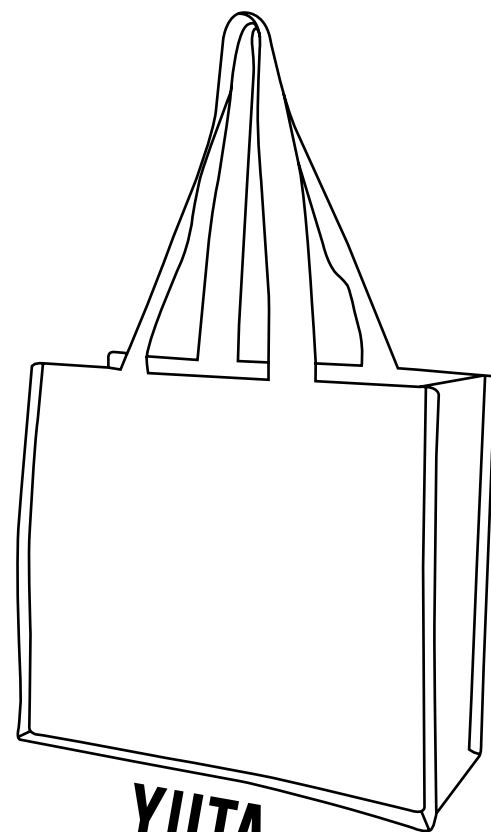

YUTA



Take a look at
travel chapter

pg. 475-485

??



greenline
427



.23



.04

79060 **leslie**

Barattolo con 6-8 semi di Petunia | Can with 6-8 Petunia seeds | Lata con 6-8 semillas de Petunia | Canette avec 6-8 semences de Petunia.
Metallo | Metal | Metal | Métal

9 cm Ø 6,5 cm ♻️ T6 | AD5 3 x 2 cm 📦 10/150



.08



.04

79035 **heta**

Vaso porta fiori con 5-8 semi di Petunia inclusi | Flowerpot with 5-8 Petunia seeds included | Maceta con 5-8 semillas de Petunia | Pots de fleurs avec 5-8 sémences de pétunia incluses

Plastica biodegradabile | Biodegradable plastic | Plástico biodegradable | Plastique biodégradable

6,2 x Ø 6,5 cm ♻️ S27 | T7 2 x 1 cm 📦 25/200

CORK LINE



.11

A5

40176 *lifer*

Block notes A5 di sughero | Cork A5 notebook | Libreta A5 con tapas de corcho | Bloc notes format A5 en liège
Sughero, carta | Cork, paper | Corcho, papel | Liège, papier

14 x 21 cm S2 | UV8 4,5 x 5 cm 50

A6

40236 *babil*

Block-notes con elastico. | Bloc notes with elastic | Bloc de notas con banda elástica | Bloc-notes fermeture élastique
Sughero | Cork | Corcho | Liège

10 x 14,5 x 1,5 cm S64 | UV8 3 x 2 cm 50/200



62057 *morganite*

Portablocco, block notes con 20 fogli incluso | Folder, 20 sheets notepad | Carpeta con bloc de notas de 20 hojas | Porte bloc avec bloc notes 20 feuilles
Sughero | Cork | Corcho | Liège

32,5 x 24,5 x 1 cm S69 | L15 1/20



40234 *babar*

Block-notes con elastico. | Bloc notes with elastic | Bloc de notas con banda elástica | Bloc-notes fermeture élastique
Similpelle, sughero | PU, cork | Polipiel, corcho | Simili-cuir, liège

10 x 14,5 x 1,5 cm S64 | L13 3 x 2 cm 50/200



.01



.11

23061 *gandosso*

Penna a sfera con astuccio | Ballpoint pen with pouch | Bolígrafo con estuche | Stylo à bille avec étuit
Sughero | Cork | Corcho | Liège

13,5 cm T4 5 x 0,5 cm 50/200



.11

40241 *madrid*

Block Notes, 50 fogli | Notepad, 50 sheets | Bloc de notas, 50 hojas | Bloc notes, 50 feuilles
Sughero | Cork | Corcho | Liège

15,5 x 11,5 x 1,7 cm S64 | L13 4 x 4 cm 1/100



40178 *östana*

Block notes con penna | Notebook with pen | Bloc de notas con bolígrafo | Bloc notes avec stylo inclus
Bambù, carta 70gr | Bamboo, paper 70gr | Bambú, papel 70gr |
Bambou, papier 70gr

9 x 14 cm ♻️ S64 | T4 4 x 4 cm 📦 100



BAMBOO line



40094 *juul*

Block Notes con 70 fogli (penna inclusa) | Notepad (70 sheets), ballpen included | Bloc notas con 70 hojas (bolígrafo incluido) | Bloc notes avec 70 feuilles (stylo à bille inclus)
Bambù | Bamboo | Bambú | Bambou

10,5 x 14,8 cm ♻️ S64 | T4 4 x 4 cm 📦 50/100



40091 *javan*

Block Notes con 70 fogli (penna inclusa) | Notepad (70 sheets), ballpen included | Bloc notas con 70 hojas (bolígrafo incluido) | Bloc notes avec 70 feuilles (stylo à bille inclus)
Bambù | Bamboo | Bambú | Bambou

13,5 x 18 cm ♻️ S64 | T4 4 x 4 cm 📦 50/100



40083 *reja*

Cartellina A4 | A4 document folder | Carpeta A4 | Chemise A4
Carta riciclata | Recycled paper | Papel reciclado | Papier recyclé

23 x 30,7 cm ♻️ S66 10 x 10 cm 📦 25/200



40085 *margo*

Cartellina A4 con penna, 20 fogli | A4 document folder with pen and 20 paper sheets | Carpeta A4, con bolígrafo, 20 hojas | Chemise A4 avec stylo, 20 feuilles
Carta riciclata | Recycled paper | Papel reciclado | Papier recyclé

23 x 32 x 1,5 cm ♻️ S66 10 x 10 cm 📦 16 /64

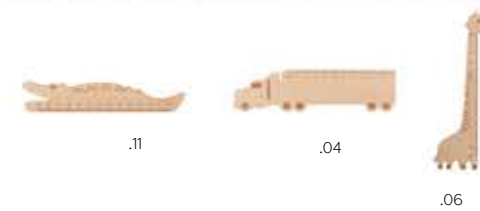
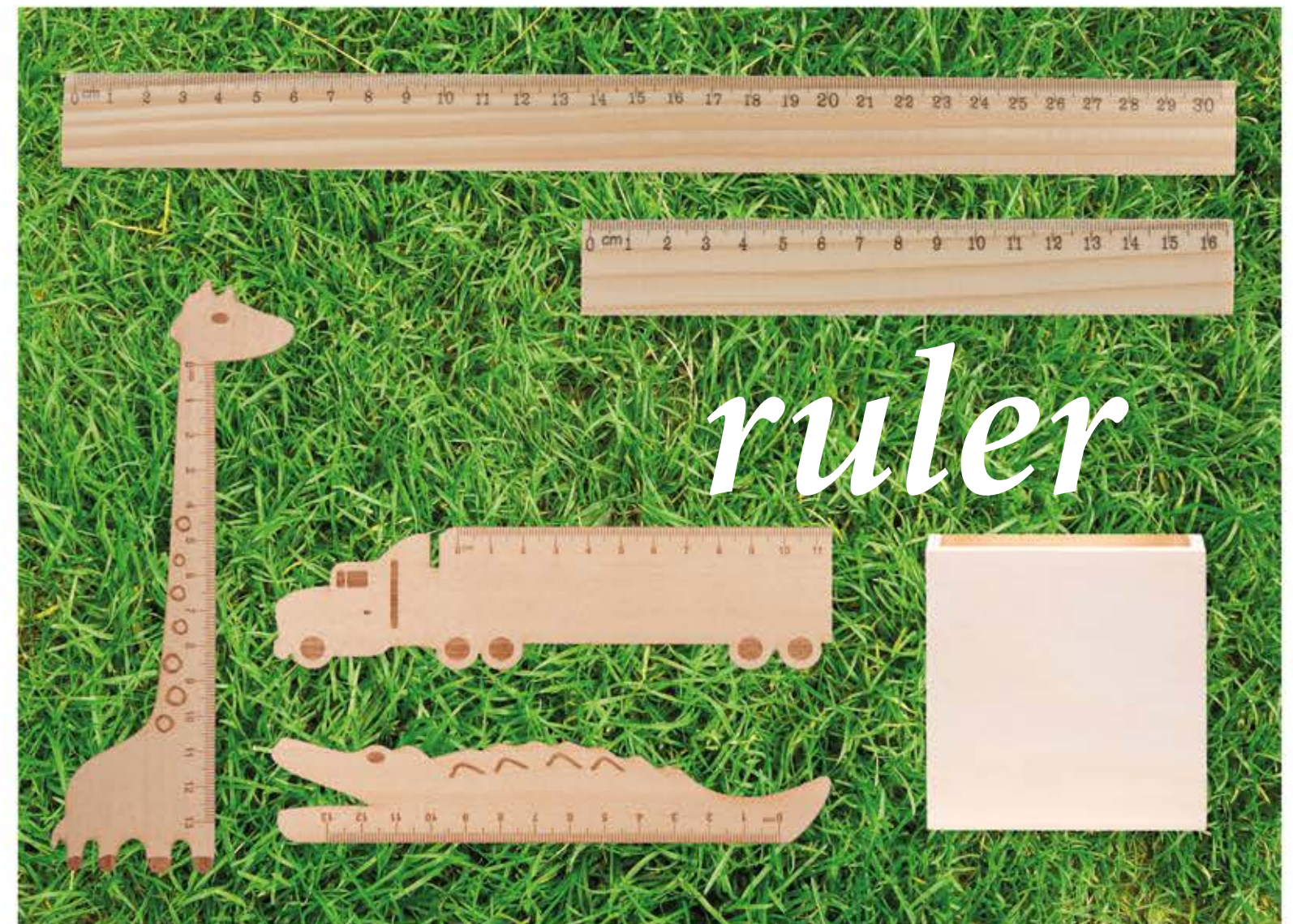

.11

.04

.06



.11



.11



.11

96116 *oxnard*

Righello 13 cm | 13 cm ruler | Regla 13 cm | Règle 13 cm
Legno | Wood | Madera | Bois

19,2 x 3,5 cm ♻️ T23 6 x 1,5 cm 📦 1000

96132 *ambroy*

Righello 16 cm | 16 cm ruler | Regla 16 cm | Règle 16 cm
Legno | Wood | Madera | Bois

17 x 2,5 x 0,3 cm ♻️ UV2 15 x 2 cm | T23 6 x 1,5 cm | S2 10 x 1,5 cm 📦 2880

96129 *word*

Righello 30 cm | 30 cm ruler | Regla 30 cm | Règle 30 cm
Legno | Wood | Madera | Bois

31 x 3,5 x 0,3 cm ♻️ UV9 28 x 1,5 cm | S2 25 x 1 cm | T23 6 x 1,5 cm 📦 1440

95120 *värdera*

Porta matite da scrivania in legno | Pencil holder in wood | Porta lápices de madera | Porte crayons de bureau en bois
Legno | Wood | Madera | Bois

8 x 8 x 9 cm ♻️ S3 5 x 5 cm

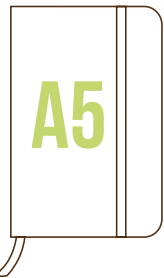
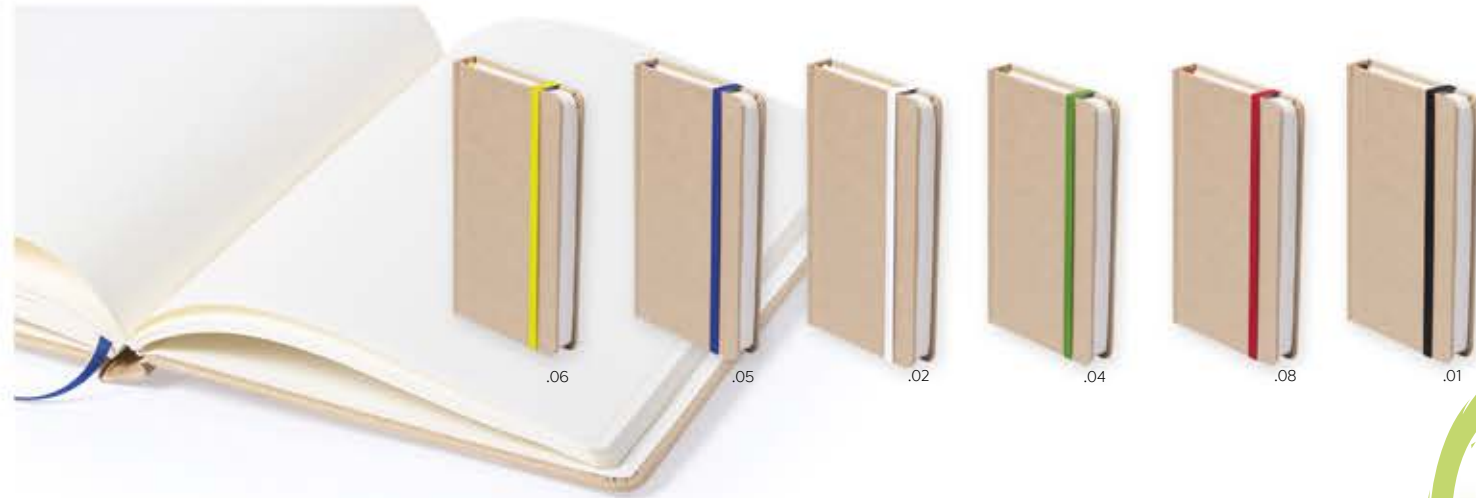

40274 *koncis*

Block notes A5 con copertina rigida. 100 pagine | A5 notebook with rigid cover. 100 pages | Libreta A5 de tapa dura. 100 páginas | Bloc notes format A5 avec couverture rigide. 100pages
Carta riciclata | Recycled Cardboard | Papel reciclado | Papier recyclé

14,7 x 21 x 1,5 cm ♻️ S76 📦 50



40275 *korken*

Block notes A6 con copertina rigida. 100 pagine | A6 notebook with rigid cover. 100 pages | Libreta A6 de tapa dura. 100 páginas | Bloc notes format A6 avec couverture rigide. 100pages
Carta riciclata | Recycled Cardboard | Papel reciclado | Papier recyclé

9,5 x 14,5 x 1,5 cm ♻️ S78 📦 100



40068 *sanna*

Block-notes con matita | Notepad with pencil | Bloc de notas con lápiz | Block notes avec crayon
Carta | Paper | Papel | Papier

8,2 x 10,5 cm ♻️ T6 | UV9 5 x 2 cm

📦 50/200

40264 *zare*

Block notes con elastico laterale - 100 fogli | Notepad with hardcover and elastic band | Blocs de notas con banda elástica - 100 pg | Carnet avec élastique latéral
Carta | Paper | Papel | Papier

10,6 x 7,5 x 1,2 cm ♻️ T6 | UV9 4 x 4 cm

📦 25/100

pad NOTE





40040 *justi*

Block-notes con spirale e penna, 70pag. Refil blu | Block-notes with ballpen. Blue refil | Bloque de notas con bolígrafo. Refil azul | Bloc-notes avec spirales en papier recyclé. 65 pages
Carta riciclata | Recycled paper | Papier recyclado | Papier recyclé

9 x 14,6 x 0,8 cm ♻️ T7 (Block-notes) | T4 (Pen) 5 x 1,5 cm 📦 50/100

BLOCK notes

greenline
434

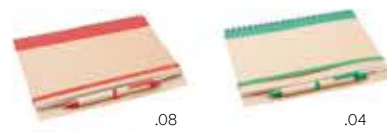

40026 *akule*

Taccuino. 60 Fogli. Inclusa Penna Cartone Riciclato. Refil blu | Recycled cardboard block-notes with blue ink pen and 60 sheets included | Libreta. 60 Hojas. Incluye bolígrafo Cartón Reciclado. Refil azul | Carnet 60 feuilles. Stylo en carton recyclé inclus. Encre bleu

Carta riciclata | Recycled paper | Papier recyclado | Papier recyclé

16,5 x 21 x 1 cm ♻️ T7 (Block-notes) | T4 (Pen) 4 x 4 cm 📦 20/80



40045 *linusb*

Taccuino maxi. 80 fogli | Maxi block-notes with 80 sheets | Libreta grande. 80 hojas | Carnet maxi. 80 feuilles
Cartone Riciclato | Recycled Cardboard | Recycled Cardboard | Carton recyclé

15 x 21,5 x 1,2 cm ♻️ S65 5 x 5 cm 📦 25/50



.13



29326 *billy*

Block-notes con blocco 50 pagine a righe, 15 memo stick da 1,5 x 4,4 cm e 75 mini memo stick da 4,4 x 7,5 cm. Penna inclusa | 50 lined sheets notepad with pen. 15 sticky notes 1,5 x 4,4 cm. 75 mini sticky notes 4,4 x 7,5 cm. | Bloc de notas con libreta de 50 páginas a rayas, 15 memo stick de 1,5 x 4,4 cm y 75 mini memo stick de 4,4 x 7,5 cm. Bolígrafo incluido | Bloc notes avec bloc de 50 pages rayées, 15 mémo stick (1,5 x 4,4cm) et 75 mini memo stick (4,4 x 7,5cm). Stylo inclus

Carta riciclata | Recycled Cardboard | Papier recyclado | Papier recyclé

9,5 x 13,2 x 1,5 cm ♻️ S64 3 x 2 cm



29327 *gosig*

Block notes con 30 memo stick da 4,5 x 6 cm e 50 mini memo stick da 1,2 x 4,5 cm | Set with 30 sticky notes 4,5 x 6 cm and 50 mini sticky notes 1,2 x 4,5 cm | 30 Notas Adhesivas 4,5 x 6 cm. 50 Mini Notas Adhesivas 1,2 x 4,5 cm. | Bloc notes avec 30 mémo stick (4,5 x 6cm) et 50 mini mémo stick (1,2 x 4,5cm)

Carta riciclata | Recycled Cardboard | Papier recyclado | Papier recyclé

5,4 x 10 x 6,5 cm ♻️ T7 3 x 2 cm



29324 *behaga*

Block notes con 100 memo stick da 5,1 x 7,5 cm e 100 mini memo stick da 1,5 x 5,1 cm | Set with 100 sticky notes 5,1 x 7,5 cm and 100 mini sticky notes 1,5 x 5,1 cm | Bloc con 100 memo sticks de 5,1 x 7,5 cm y 100 mini memo sticks de 1,5 x 5,1 cm | Bloc notes avec 100 mémos stick (5,1 x 7,5cm) et 100 mini memo stick (1,5 x 5,1cm)

Carta riciclata | Recycled Cardboard | Papier recyclado | Papier recyclé

10,8 x 8,5 x 2,5 cm ♻️ S64 3 x 2 cm

greenline
435





.00

40106 *zinzuli*

Block-notes con blocco (70 Fogli), memo stick(25fg, 10 x 7,5 cm/125fg, 7,5 x 1,5 cm) e penna | Sticky Notepad, Recycled Cardboard, 70 Sheets Notepad, 25 Sticky Notes 10 x 7,5 cm, 125 Mini Sticky Notepad 7,5 x 1,5 cm, Pen Included | Block de notas de papel reciclado con libreta (70 hojas), memo stick(25 hojas de 10x7,5 cm/125 hojas de 7,5x1,5 cm) y bolígrafo | Bloc Notes avec bloc de 70Pages + 25 post it: 10 x 7,5 cm + 125 Adhésifs: 7,5 x 1,5cm, Stylo Inclu
Cartone | Carton | Papel | Carton

21 x 20 x 1 cm ♻️ S66 | T4 5 x 5 cm 📦 50



.00

40181 *rukwa*

Segnalibro con foglietti segnapagina | Bookmark with sticky notes set | Marcador con set notas | Marque-pages avec memo stick
Cartone riciclato | Recycled Cardboard | Papel reciclado | Papier recyclé

21 x 6 cm ♻️ S1 3,5 x 2 cm 📦 50 / 500



.00

40100 *hubert*

Segnalibro con foglietti segnapagina | Bookmark with sticky notes set | Marcador con set notas | Marque-pages avec memo stick
Cartone | Carton | Carton | Carton

6,4 x 14,8 cm ♻️ S1 4 x 2 cm 📦 100/600

MEMO stick



.13

.02

.01

29094 *darice*

Memo stick, 100 pcs | Book markers, 100 pcs | Adhesivos 100 pcs | Memo stick 100 pièces
Carta | Paper | Papel | Papier

8,2 x 6 x 0,3 cm ♻️ S2 2 x 3 cm
25/500



.13

40116 *buenos aires*

Block notes con memo stick. Penna inclusa | Notebook with memo sticks | Bloc de notas con memo sticks | Block notes avec memo stick
Cartone | Carton | Carton | Carton

libretto 9 x 0,5 x 11,5 cm - penna 9,5 cm
S64 | T4 3 x 3 cm 📦 200



.13

40101 *per*

Block notes con Memo stick e penna a sfera | Notepad with sticky notes and ballpoint pen | Block-notes con Memo stick y bolígrafo | Bloc-notes avec Memo stick et stylo à bille
Cartone riciclato | Recycled carton | Carton reciclado | Carton recyclé

9,5 x 10,5 x 0,6 cm ♻️ S2 | T4 3 x 3 cm
50/200



.23



.13



.08

40173 *vidga*

Block notes A5 con chiusura elastica e copertina in stoffa. 80 pagine | Notebook A5 with elastic closure and fabric cover. 80 pages | Libreta A5 con cierre elástico y tapa de tela. 80 páginas | Bloc notes A5 avec fermeture élastique et couverture en tissu. 80 pages
Poliestere, carta | Polyester, paper | Poliéster, papel | Polyester

14,5 x 21 cm ♻️ S78 5,5 x 5,5 cm 📦 50



.13

40047 *solja*

Block notes con set di 7 memo stick (25 pz caduno)
| Office set with sticky notes and book markers (25 sheets)
| Bloc de 7 conjuntos memo stick (25 hojas cada uno)
| Bloc-notes avec set de 7 modeles de memo stick colorés

Carta | Paper | Papel | Papier

8 x 10,5 x 0,9 cm ♻️ S2 4 x 4 cm 📦 48/288

MEMO *stick*



29099 *amira*

Post it | Book markers | Memos adhesivos | Memo stick
Cartone, carta | Carton, paper | Carton, papel | Carton, papier

8 x 8 cm ♻️ S1 | UV2 3 x 2 cm 📦 25/500



29108 *heidi*

Portapenne | Penholder | Portalápices | Porte-stylos
Plastica | Plastic | Plástico | Plastique

7,2 x 13,8 x 9,1 cm ♻️ T6 5 x 3 cm 📦 1/100



.02



.18

29101 *wapi*

Pinzatrice ecologica senza punti | Ecologic stapler | Perforadora ecologica | Agrafeuse écologique sans agrafes
Plastica | Plastic | Plástico | Plastique

6 x 5,5 x 5,5 cm ♻️ T7 | UV3 3 x 1,5 cm 📦 24/288



.18



.17

40011 *varma*

Blocco con fogli in colori trendy | Block-notes | Set con papeles | Mini-Bloc avec feuilles colorées
Carta | Paper | Papel | Papier

8,1 x 8 x 2,4 cm ♻️ S3 | UV17 4 x 4 cm 📦 1/100

TRAVEL & BAGS

wandering AROUND

Borse shopping, porta pizze e da spiaggia in materiali ecologici e non. Borse pieghevoli, shopping trolley. Zaini e trolley per viaggiare, adattatori universali per prese, pochette e accessori in feltro, borsoni e zaini porta PC.

440 - 513

borse e viaggio - travel and bags - bolsos y viajes - voyage et bagages



17076 *class*

Borsa shopping | Shopping bag | Bolsa de la compra | Shopping Non-Woven

38 x 33,5 x 10 cm S75 (white bag) | S76 (coloured bags) | TR7 25 x 25 cm 10/100

17140 *wikko*

Borsa shopping | Shopping bag | Bolsa de la compra | Sac de shopping TNT

38 x 42 x 7 cm S76 | TR7 25 x 25 cm 50/250



54039 *kioto*

Borsa shopping con tasca frontale | Shopping bag with front pocket | Bolsa compra con bolsillo delantero | Sac shopping avec poche frontale Non-woven laminato 160gr/m2 | Laminated TNT 160gr/m2 | TNT Laminado 160gr/m2 | TNT Laminé 160gr/m2

35 x 37,5 x 19,5 cm S98 10 x 10 cm 10/100



17013 *lies*

Borsa | Shopping bag | Bolso | Sac
Non-Woven

40 x 34 x 20 cm S76 | TR7 10 x 10 cm 50/200



17092 *pepita*

Borsa shopping | Shopping bag | Bolsa de la compra | Sac shopping
TNT

45 x 35 x 10 cm S75 | TR7 20 x 20 cm 10/200



17098 *minna*

Borsa shopping | Shopping bag | Bolso de la compra |
Sac shopping
Non-Woven

33 x 41,5 cm S75 | TR7 25 x 25 cm 250

Delighting with COLOURS...



54011 *hajo*

Borsa shopping e mare | Shopping or beach bag | Bolsa compra y playa
| Sac shopping etlou de plage
Non Woven

40 x 35,5 x 13 cm S75 | TR7 20 x 20 cm 50/200



17053 *arbo*

Borsa manico corto (50cm) | Bag with short handle (50 cm) | Bolsa asas
cortas (50 cm) | Sac avec haneses courtes (50 cm)
Non woven

40 x 35 x 7 cm S75 (white bag) | S76 (coloured bags) |
TR7 25 x 25 cm 50/250



54016 *necocarpo*

Borsa bianca con finiture colorate | Bag | Bolsa blanca con ribetes de
colores | Sac shopping avec décors colorés
Non-Woven

38 x 40 x 8 cm S75 | TR7 25 x 25 cm 200



17080 *thora*

Borsa con manici 30 cm | Bag with 30cm handles | Bolsa con asas de
30cm | Sac avec haneses de 30 cm
Non-Woven

20 x 25 x 7 cm S75 (white bag) | S76 (coloured bags) |
TR7 13 x 18 cm 50/200



17041 *ankra*

Borsa porta pizze | Pizza bag | Bolsa porta pizza | Sac porte pizzas
Non-Woven

33 x 33 x 33 cm S75 (white bag) | S76 (coloured bags) | TR7 25 x 20 cm
1/200



64126 *mobile*

Borsa per sublimazione, stampa esclusa | Shopping Bag, printing
excl. | Bolsa, marcaje excl. | Sac shopping. Marcaje excl.
TNT

36 x 40 cm S75 SP17 19,5 x 28,5 cm 20/400



17022 *sneld*

Sacca shopper | Shopping bag | Bolsa de la compra | Sac shopping
Non Woven

34 x 44 cm S75 (white bag) | S76 (coloured bags) | TR7 23 x 23 cm 20/400



17184 *sedlig*

Borsa shopping con manici lunghi e tasca frontale | Shopping
bag with pocket | Bolsa de la compra con bolsillo | Sac shopping
avec hanches longues et poche frontale
TNT No Woven 80gr | TNT No Woven 80gr | TNT No Woven
80gr | TNT No Woven 80gr

41 x 37,5 cm S77 20 x 15 cm 20/200



17107 *nanda*

Borsa shopping | Shopping bag | Bolsa de la compra | Sac shopping
Non-woven

38 x 35 cm S75 (white bag) | S76 (coloured bags) | TR7 25
x 25 cm 50/250



17030 *siggo*

Borsa con cerniera | Zipped shopping bag | Bolsa con cremallera |
Shopping avec fermeture éclair
Non-Woven

50 x 41,5 cm S98 | TR7 25 x 25 cm 20/160





17046 *jos*

Borsa biodegradabile | Ecofriendly bag | Bolsa ecológica | Sac biodégradable
Biodegradabile | biodegradable | Biodégradable

38 x 38 x 12 cm S98 25 x 25 cm 20/100

We're the **SHINY** CHIC ones in the family



.02



17139 *nastola*

Borsa shopping laminata | Handbag | Bolsa de la compra | Sac
Non-woven laminato | Laminated TNT | TNT Laminado | TNT Laminé

38 x 40 x 12 cm S98 25 x 25 cm 10/200

17178 *gerenzago*

Borsa shopping. Chiusura con bottone. Manici in nylon | Shopping bag with
gusset and snap button closure | Bolsa de la compra con cierre de botón y
fuelle | Sac shopping avec soufflet et fermeture avec bouton

Polipropilene | Polypropylene | Polypropylene | Polypropylene

35 x 34,5 x 22 cm S6 15 x 15 cm 10/100

SHOPPING *bag*

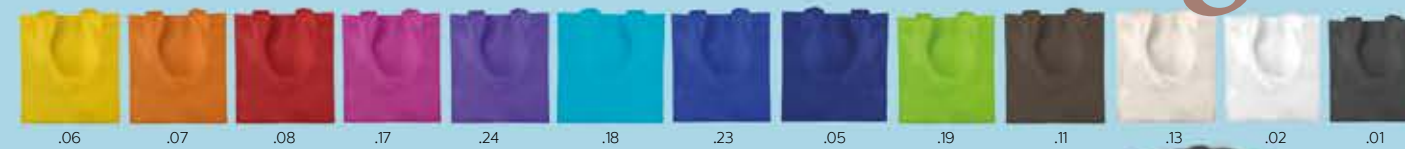

17074 *linn*

Borsa shopping cucita con manici lunghi | Sewing shopping bag with long handle |
Bolso de la compra cosida | Shopping avec hanches longues
Non-Woven 80 gr/m2

38 x 42 cm S75 (white bag) | S76 (coloured bags) | TR7 25 x 25 cm

250



17056 *dolf*

Sacca shopper richiudibile, manico 35 cm | Foldable bag, 35 cm handle | Bolsa plegable, asa 35cm | Shopping avec fermeture, hanches 50cm
Non-Woven

35 x 41 x 10 cm S31 18 x 18 cm 40/200



64025 *asik*

Borsa pieghevole | Foldable bag | Bolsa plegable | Sac shopping pliable
Non-Woven

45 x 32 x 13 cm S31 18 x 18 cm 10/200



17045 *taleon*

Shopper pieghevole manico corto | Foldable shopping bag with short handles | Bolsa plegable con asas cortas | Sac shopping pliable
Non-Woven

38 x 42 cm S31 18 x 18 cm 50/200



17146 *adele*

Borsa shopping ecologica | Ecofriendly laminated PP bag | Bolsa ecológica | Sac shopping écologique
PP

40 x 35 x 13 cm S6 25 x 25 cm 20/200



54020 *wip*

Borsa laminata in vari colori moda | Laminated bag | Bolsa brillante | Sac brillant plusieurs couleurs
Non-Woven

42 x 35 x 12 cm S98 25 x 20 cm 50/200



17193 *carbon*

Borsa shopper | Shopping bag | Bolsa shopping | Sac shopping
Non woven | Non woven | Non woven | TNT Non woven

52 x 40,5 x 15 cm S76 20 x 20 cm 20 / 200

alf



Travel & bags

450

64032 **alf**

Borsa orsetto | Bear bag | Bolso oso | Sac en forme d'ourson
 Poliestere laminato | Laminated polyester | Poliéster laminado | Polyester laminé

38 x 42 cm open - 26 x 15 cm (close) ♻️ S31 15 x 15 cm

25/100

64004 **marisol**

Borsa shopping pieghevole in custodia con moschettone | Foldable shopping bag in pouch with belt clip | Bolso de la compra plegable en funda con mosquetón | Sac shopping repliable dans son étui
 Poliestere 190t | Polyester 190t | Poliéster 190t | Polyester 190t

8 x 10 x 2,5 cm (closed) ♻️ S31 15 x 15 cm 50/200

SHOPPING bag



.45



.19



.17



.13



.48



.11

17501 **pjätterydsilverån**

Borsa shopping con manici e soffietto a contrasto | Shopping bag with handles and bellows in a different colour | Bolsa de la compra con fuelle y asas de distinto color | Sac shopping avec hanches et soufflet en contraste

TNT No Woven 80gr | TNT No Woven 80gr | TNT No Woven 80gr | TNT No Woven 80gr

51 x 39,5 x 14 cm ♻️ S76 20 x 20 cm 10/100





.02



.06 .07 .01 .08 .04 .23



.08



.08



.02 .07 .04 .23 .06 .17 .01

64086 maggy

Borsa shopping pieghevole | Foldable shopping bag | Bolsa de la compra plegable | Sac shopping repliable
 Poliestere 190T | Polyester 190T | Poliéster 190T | Polyester 190T

37 x 37 x 6 cm S31 | SP16 (only for white colour) 15 x 15 cm

10/400

17048 dervis

Rosa | Rose | Rosa | Rose
 Borsa Pieghevole | Foldable Bag | Bolso Plegable | Sac repliable
 Poliestere 190t | Polyester 190t | Poliéster 190t | Polyester 190t

38 x 38 cm S31 20 x 20 cm 10/400

64124 merrimack

Borsa pieghevole | Foldable Bag | Bolsa plegable | Sac Pliable
 Poliestere 190T | Polyester 190T | Poliéster 190T | Polyester 190T

42,5 x 38 x 7 cm S31 | SP16 (only for the white colour) 20 x 20 cm

20/400



.23
.02
.04
.07
.08
.01
.06

17175 gioiosa

Shopper pieghevole | Foldable shopping bag | Bolsa plegable con asas largas
 | Sac shopping pliable
 Poliestere | Polyester | Poliéster | Polyester

38 x 42 cm S31 20 x 25 cm 50/200



.18



.07 .05

64003 ergin

Borsa shopping pieghevole, in custodia | Foldable shopping bag with belt clip
 | Bolso de la compra plegable en funda con mosquetón | Sac shopping repliable dans son étui
 Poliestere | Polyester | Poliéster | Polyester

(close) 6,5 x 11 cm - (open) 44 x 41 cm S31 15 x 15 cm 10/150



.07

17057 amanda

Mandarino | Mandarin | Madarina | Mandarin

Borsa Pieghevole | Foldable Bag | Bolso Plegable | Clementine - Sac repliable
 Poliestere 190t | Polyester 190t | Poliéster 190t | Polyester 190t

38 x 40 cm S31 15 x 15 cm 10/400



.08

17062 julia

Pomodoro | Tomato | Tomate | Tomates

Borsa Pieghevole | Foldable Bag | Bolso Plegable | Sac repliable
 Poliestere 190t | Polyester 190t | Poliéster 190t | Polyester 190t

38 x 40 cm S31 15 x 15 cm 10/400



.08

17051 anja

Fragola | Strawberry | Fresa | Fraise

Borsa Pieghevole | Foldable Bag | Bolso Plegable | Fraise - Sac repliable
 Poliestere 190t | Polyester 190t | Poliéster 190t | Polyester 190t

38 x 40 cm S31 15 x 15 cm 10/400



64138 *clarence*

Trolley per la spesa pieghevole | Foldable trolley | Carrito plegable | Trolley pliable

Poliestere 600D | Polyester 600D | Poliéster 600D | Polyester 600D

32 x 55 x 21 cm (open) ♻️ S100 15 x 15 cm 📦 6



64091 *edna*

Shopping trolley pieghevole | Collapsible shopping trolley | Carro de la compra plegable | Sac shopping pliable avec roulettes

Poliestere 600D | Polyester 600D | Poliéster 600D | Polyester 600D

33 x 56 x 14,5 cm (open) 33 x 20 cm (close) ♻️ S100 15 x 10 cm 📦 6/36

PAPER bag



17128 *antsla*

Borsa riciclabile | Recycling bag | Bolsa reciclaje | Savon de bain Polipropilene | Polypropylene | Polipropileno | Polypropylène

70 x 30 x 44 cm ♻️ S16 15 x 10 cm 📦 20/60



17109 *crustini*

Borsa riciclabile | Recycling bag | Bolsa reciclaje | Savon de bain Tnt Laminato | Laminated TNT

69 x 45 x 23 cm ♻️ S16 15 x 10 cm

17507 *mytisk*

Borsa di carta | Paper bag | Bolsa de papel | Sac en papier Carta 100g | Paper 100gsm | Papel 100gr | Papaer 100 gr.

25 x 31 x 11 cm ♻️ S77 14 x 14 cm 📦

17508 *norråker*

Borsa di carta | Paper bag | Bolsa de papel | Sac en papier Carta 100g | Paper 100gsm | Papel 100gr | Papaer 100 gr.

41 x 32 x 12 cm ♻️ S77 14 x 14 cm 📦 200

17510 *norden*

Borsa di carta per 1 bottiglia | Paper bag for 1 bottle | Bolsa de papel para 1 botella | Sac en papier pour 1 bouteille Carta 100g | Paper 100gsm | Papel 100gr | Papaer 100 gr.

11 x 36 x 10 cm ♻️ S77 10 x 6 cm

17509 *nockeby*

Borsa di carta | Paper bag | Bolsa de papel | Sac en papier Carta 100g | Paper 100gsm | Papel 100gr | Papaer 100 gr.

32 x 40 x 12 cm ♻️ S77 14 x 14 cm 📦 200

17506 *myndig*

Borsa di carta | Paper bag | Bolsa de papel | Sac en papier Carta 80g | Paper 80gsm | Papel 80gr | Papaer 80 gr.

30 x 29 x 18 cm ♻️ S77 12 x 12 cm 📦 200

17505 *munsbit*

Borsa di carta | Paper bag | Bolsa de papel | Sac en papier Carta 100g | Paper 100gsm | Papel 100gr | Papaer 100 gr.

22 x 23 x 9 cm ♻️ S77 10 x 10 cm 📦 200



17504 *sinnessro*

Borsa shopping con manici lunghi a contrasto | Shopping bag with coloured handles | Bolsa de la compra con asas de color | Sac shopping avec hanches longues en contraste
Cotone 280gr | Cotton 280gr | Algodón 280gr | Coton 280gr

36 x 34 x 12 cm ♻️ SP41 20 x 20 cm 📦 100



54029 *caladio*

Borsa con tasca interna | Bag with inside pocket | Bolsa con bolsillo interno | Sac avec pochette
Cotone 280 gr/m² | Cotton 280 gr/m² | Algodón 280 gr/m² | Coton 280 gr/m²

45 x 38 x 10,5 cm ♻️ S75 | TR22 20 x 20 cm

📦 50/100

17192 *nyumba*

Borsa shopper | Shopping bag | Bolsa shopping | Sac shopping
Cotone 240gr | Cotton | Algodón | Coton

39 x 42 x 13 cm ♻️ S75 | TR22 20 x 20 cm

📦 20 / 100

17179 *gaggiano*

Shopper in cotone | Shopping bag | Bolsa de la compra | Sac shopping
Cotone 140 g/m² | Cotton 140g/m² | Algodón 140 g/m² | Coton 140 g/m²

37,5 x 41,5 cm ♻️ S75 | TR22 25 x 25 cm

📦 50/250



.13

OTTON *bag*

17012 reumu

38 x 42 cm S75 | TR22 25 x 25 cm 50/250



.13



.13

17007 toffsy

Borsa con manico corto | Short handles bag | Bolso con asas cortas | Sac shopping avec hanches courtes
Cotone | Cotton | Algodón | Coton

38 x 42 cm S75 | TR22 25 x 25 cm 50/250

17136 lipsia

Borsa shopping con manici lunghi | Shopping bag with long handles | Bolsa de la compra con asas largas | Sac shopping avec hanches longues
Cotone 140 g/m2 | Cotton 140g/m2 | Algodon 140 g/m2 | Coton 140 g/m2

42 x 50 cm S75 | TR22 25 x 25 cm 100



17012 reumu

Borsa con manico lungo | Long handles bag | Bolsa con asas largas | Sac shopping avec hanches longues
Cotone | Cotton | Algodón | Coton

38 x 42 cm S75 | TR22 25 x 25 cm 50/250



.13

65043 *ebast*

Zaino | Drawstring bag | rucksack | Mochila | Sac à dos avec coulisse
Cotone | Cotton | Algodón | Coton

37 x 40 cm ♻️ S75 | TR22 20 x 20 cm 📦 10/200



.13

17803 *brimnes*

Borsa shopper con manici larghi | Shopping bag with large handles | Bolsa de la compra de asas anchas | Sac shopping avec hanches larges
Cotone 100 g/m2 | Cotton 100 g/m2 | Algodón 100 g/m2 | Coton 100g/m2

42,5 x 38 x 7 cm ♻️ L1



.05

.08



17502 *skänka*

Borsa da mare con cerniera e base a contrasto. Manici tubolari. | Beach bag with coloured zip. Tubular handles | Bolsa de la compra con cremallera de color y asas tubulares | Sac shopping avec hanches cylindriques, fermeture éclair et base en contraste.
Juta | Jute | Yuta | Jute

44 x 38 x 12 cm ♻️ S6 20 x 15 cm 📦 100



.08



.23

.04

.01

64533 *björksta*

Zaino | Drawstring bag | Mochila | Sac à dos
100% cotone | 100% cotton | 100% algodón | 100% coton

37 x 41 cm ♻️ S75



.08



.23

.01

.08

.04

65888 *blanda*

Borsa a cilindro | Cylinder bag | Bolsa cilíndrica | Sac cylindrique
100% cotone | 100% cotton | 100% algodón | 100% coton

Ø 12 x 38 cm ♻️ S100

SHOPPING *bag*



.05

.08

17181 *gagliano*

Shopper con soffietto | Shopping bag | Bolsa de la compra
Poliestere 600D | Polyester 600D | Poliéster 600D | Polyester 600D

50 x 40 x 14,5 cm ♻️ S6 30 x 20 cm 📦 10/50



.13

17503 *sensuell*

Borsa shopping con manici lunghi e soffietto | Shopping bag with long handles | Bolsa con fuelle y asas largas | Sac shopping avec hanse longues
Yuco | Yuco | Yuco | Yuco

40 x 35 x 17,5 cm ♻️ S6 20 x 20 cm 📦 100



.05

.08

54043 *essauira*

Shopper | Shopping bag | Bolsa | Sac shopping
Cotone 220gr | Cotton 220gr | Algodón 220gr | Coton 200gr

45 x 36 x 20 cm ♻️ S6 20 x 20 cm 📦 50



17806 *busunge*

Borsa con manico colorato | Shopping bag with coloured handles | Bolsa con asas de color | Sac avec hanches colorées
Juta | Jute | Yute | Jute

38 x 41 cm ♻️ S6



.13

17805 *brogrund*

Borsa shopper con manici e tasca a contrasto | Shopping bag with contrast coloured handles and pocket | Bolsa de la compra con asas y bolsillo en contraste | Sac shopping avec hanches et poche en contraste
Juta | Jute | Yute | Jute

48 x 35x 15 cm ♻️ S6



.13

17191 *natron*

Borsa shopper con manici corti | Shopping bag with short handles | Bolsa shopping con asas cortas | Sac avec anses courtes
Juta | Jute | Yute | Jute

26 x 22 x 14 cm ♻️ S98 10 x 10 cm 📦 10 / 100



.13

54028 *magilla*

Borsa shopper | Shopper bag | Bolsa de la compra | Sac shopping
Juta | Jute | Yute | Jute

44 x 33,5 x 15 cm ♻️ S6 25 x 20 cm 📦 1 / 50



.13

17804 *ribuelos*

Borsa shopper con tasca | Shopping bag with pocket | Bolsa de la compra con bolsillo | Sac shopping avec poche
Juta | Jute | Yute | Jute

44,5 x 34 x 15 cm ♻️ S6 20 x 10 cm



.23



.08

.13



.19

.07



.05



.23



.08

.04

.06



.02

.07

.01



.17

.05



.02



.07

.23

17180 *gairo*

Shopper bicolore | Shopping bag. | Bolsa de la compra | Sac shopping
Juta | Yute | Yute | Jute

44 x 34 S6 25 x 20 cm 100

17189 *mdutu*

Borsa Shopper - jeans | Shopping bag - jeans | Bolsa shopping | Sac shopping
Poliestere | Polyester | Poliéster | Polyester

34 x 41 cm S6 23 x 25 cm 20 / 200

17009 *odine*

Borsa con manico lungo | Long handles bag | Bolsa con asas largas | Sac shopping avec hanches longues
Cotone | Cotton | Algodón | Coton

38 x 42 cm S75 (white bag) | S76 (coloured bags) | TR22 (white bag) | TR7 (coloured bags) 25 x 25 cm 50/250

17018 *estela*

Borsa con manico corto | Short handles bag | Bolso con asas cortas | Sac shopping avec hanches courtes
Cotone | Cotton | Algodón | Coton

38 x 42 cm S75 (white bag) | S76 (coloured bags) | TR7 (white bag) | TR7 (coloured bags) 25 x 25 cm 50/250



.13



.13



.13



.18



.06

.19



.17

.07



.23



.01

.08

17026 *jenni*

Borsa ecologica | Ecofriendly bag | Bolsa ecológica | Sac écologique
Juta | Jute | Yute | Jute

38 x 42 cm S6 25 x 25 cm 1/100

17060 *keme*

Borsa ecologica | Ecofriendly bag | Bolsa ecológica | Sac écologique
Cotone organico | Organic cotton | Algodón organico | Coton organique

40 x 40 x 10 cm S5 25 x 25 cm

10/200

17029 *guya*

Borsa ecologica | Ecofriendly bag | Bolsa ecológica | Sac écologique
TNT laminato carta | TNT Paper-Like | TNT imitación papel | Papier TNT

35 x 40 cm S6 25 x 25 cm

50/250

17021 *raimo*

Borsa nera con manico lungo | Bi color bag with long handles | Bolsa negra con asas largas | Sac noir avec hanches longues
Cotone | Cotton | Algodón | Coton

38 x 42 cm S76 | TR7 25 x 25 cm 50/250

64030 *fons*

Borsa con manico lungo | Shopping bag with long handles | Bolsa con asas largas | Sac avec hanches longues
Poliestere 190T | Polyester 190T | Poliéster 190T | Polyester 190T

38 x 42 cm S76 | TR7 25 x 25 cm 50/300

BEACH *bag*



.18



.23



.19

.07

.17



.19



.18



.07

.17

.08

.29

54014 *ubba*

Borsa con borsellino | Bag with purse | Bolsa con monedero | Sac avec portemonnaie

Poliestere 600D | Polyester 600D | Poliéster 600D | Polyester 600D

52,5 x 38,5 x 21 cm | S98 | TR6 15 x 15 cm | 1/30



.23



.08

.06

.07

.04

.02

.01

.17

54012 *rikke*

Borsa con borsellino | Bag with purse | Bolsa con monedero | Sac avec portemonnaie

Poliestere 600D | Polyester 600D | Poliéster 600D | Polyester 600D

47 x 34 x 12,5 cm | S98 | SP16 (only for white colour) | TR6 20 x 20 cm

1/50

54015 *pixie*

Borsa da spiaggia | Beach bag | Bolsa de la compra | Sac de plage

Poliestere | Polyester | Poliéster | Poliestère

48 x 40 x 10,5 cm | S98 | TR6 20 x 20 cm | 10/40

54006 *mirl*

Borsa da spiaggia, con portamonete | Beach bag with zipped purse | Bolso de playa con monedero, cierre cremallera y asas largas | Sac de plage avec portemonnaie

Poliestere 600D | Polyester 600D | Poliéster 600D | Polyester 600D

62 x 18 x 40 cm | S98 | TR6 20 x 10 cm | 1/50

SUMMER

paradise

travel & bags



.45

54026 *croco*

Borsa da mare bicolore con manici in corda - interno foderato | Bicolor beach bag with rope handles | Mochila bicolor con asas de cuerda | Sac de plage bicolore poignées corde
 Poliestere 600D | Polyester 600D | Polyester 600D | Polyester 600D

☞ 43 x 37 x 17 cm ☞ S98 | TR6 5 x 3 cm ☞ 10/30



.17

54017 *gryaznoye*

Borsa da spiaggia | Beach bag | Bolso playa | Sac da Plage
 Poliestere 600D | Polyester 600D | Poliéster 600D | Polyester 600D

☞ 46 x 33 x 12 cm ☞ S98 | TR6 20 x 20 cm ☞



55790 *stabil*

Sacca da mare. Chiusura con bottone magnetico | Beach bag with magnetic button closure | Bolsa de playa con botón magnético | Sacoche de plage. Fermeture avec bouton magnétique
 Juta, cotone | Jute, cotton | Yuta, algodón | Jute, coton

☞ 53 x 39 x 19,5 cm

.13



64536 *speciell*

Sacca da spalla con tasca | Drawstring bag with pocket | Mochila con bolsillo | Sacoche avec poche
 Jute, cotone | Jute, cotton | Yuta, algodón | Jute, coton

39,5 x 37,5 cm



55089 *sprutt*

Sacca da mare monospalla, tasca e coulisse | Beach bag with pocket and 1 shoulder strap | Macuto de playa con bolsillo y cierre con cuerdas | Sacoche de plage mono bretelle, poche et coulisse
 Jute, cotone | Jute, cotton | Yuta, algodón | Jute, coton

37 x Ø 28 cm





.07

17085 *rodeu*

Borsa shopping double face | Reversible bag | Bolso de compras, 2 caras | Sac shopping double-face
Nylon

65 x 46 cm S98 10 x 10 cm 50/100



.05



.07

.08

.17

54019 *magadan*

Borsa da spiaggia | Beach bag | Bolso playa | Sac da Plage
Canvas | Canvas | Canvas | Canvas

27 x 15 x 44 cm S98 | TR6 15 x 15 cm 50



.07

.08

.01

54003 *jonas*

Borsa da spiaggia | Beach bag with long handles | Bolsa playa | Sac de plage

Poliestere 600D | Polyester 600D | Poliéster 600D | Polyester 600D

39 x 35 x 7 cm S97 | TR7 | SP 15 x 10 cm 1/50



.01

54013 *lolita*

Borsa shopping lucente | Shiny shopping bag | Bolso de compra | Sac brillant
PVC

47 x 37 x 14 cm S100 15 x 15 cm 1/25



.03

.05

.08

54040 *marina*

Borsa shopping | Shopping bag | Bolso compra | Sac shopping
Feltro | Felt | Fieltro | Feutre

38 x 28 x 14 cm S98 | TR6 20 x 20 cm 1/50



.03

54035 *florida*

Borsa shopping | Shopping bag | Bolsa | Sac shopping
Feltro | Felt | Fieltro | Feutre

40 x 32 x 12 cm S98 | TR6 20 x 15 cm 1/50



.03

.01

43019 *zoe*

Pochette | Clutch bag | Neceser | Pochette
Feltro | Felt | Fieltro | Feutre

20 x 12 x 6 cm S8 | TR1 8 x 4 cm 1/200



.08



.13



.13

.05

.01



.04

.23

.05

.01

.08

60133 *vyssa*

Portadocumenti con manico corto e tracolla | Documents holder with short handle and shoulder strap | Bolsa de congresos con asa y cinta para el hombro | Porte documents avec hanches courtes et bandoulière
Poliestere 600D | Polyester 600D | Poliéster 600D | Polyester 600D

📏 40 x 7 x 33 cm 💧 S78 📦 25

60136 *kafferep*

Portadocumenti imbottito | Padded documents holder | Portadocumentos acolchado | Porte documents rembourré
Poliestere 600D | Polyester 600D | Poliéster 600D | Polyester 600D

📏 27 x 35,5 x 3,5 cm 💧 S78 📦 50



.03



.05

.01

60134 *kännetecken*

Tracolla | Conference bag with shoulder strap | Bandolera | Sac bandoulière
Poliestere 600D | Polyester 600D | Poliéster 600D | Polyester 600D

📏 31 x 43 x 11 cm 💧 S78 📦 30



.04

60003 *petete*

Borsa portadocumenti con tasca frontale portacellulare | Document bag with mobile phone pocket in the front | Bolsa portadocumentos con bolsillo frontal para móviles | Sac porte-documents avec poche frontal
Poliestere 600D, similpelle | Polyester 600D, imitation leather | Poliéster 600D, Polípiel | Polièstere

📏 29,5 x 9 x 38 cm 💧 S78 | TR9 10 x 10 cm 📦 50

DOCUMENT *bag*



.01



.13



60137 *uguanda*

Borsa conferenza con porta notebook | Congress bag with capacity for the laptop | Bolsa de congresos con capacidad para portatil. | Sac a congres avec emplacement pour ordinateur portable
Poliestere 600D | Polyester 600D | Poliéster 600D | Polyester 600D

📏 39 x 30 x 8 cm 💧 S78 20 x 10 cm 📦 1 / 25

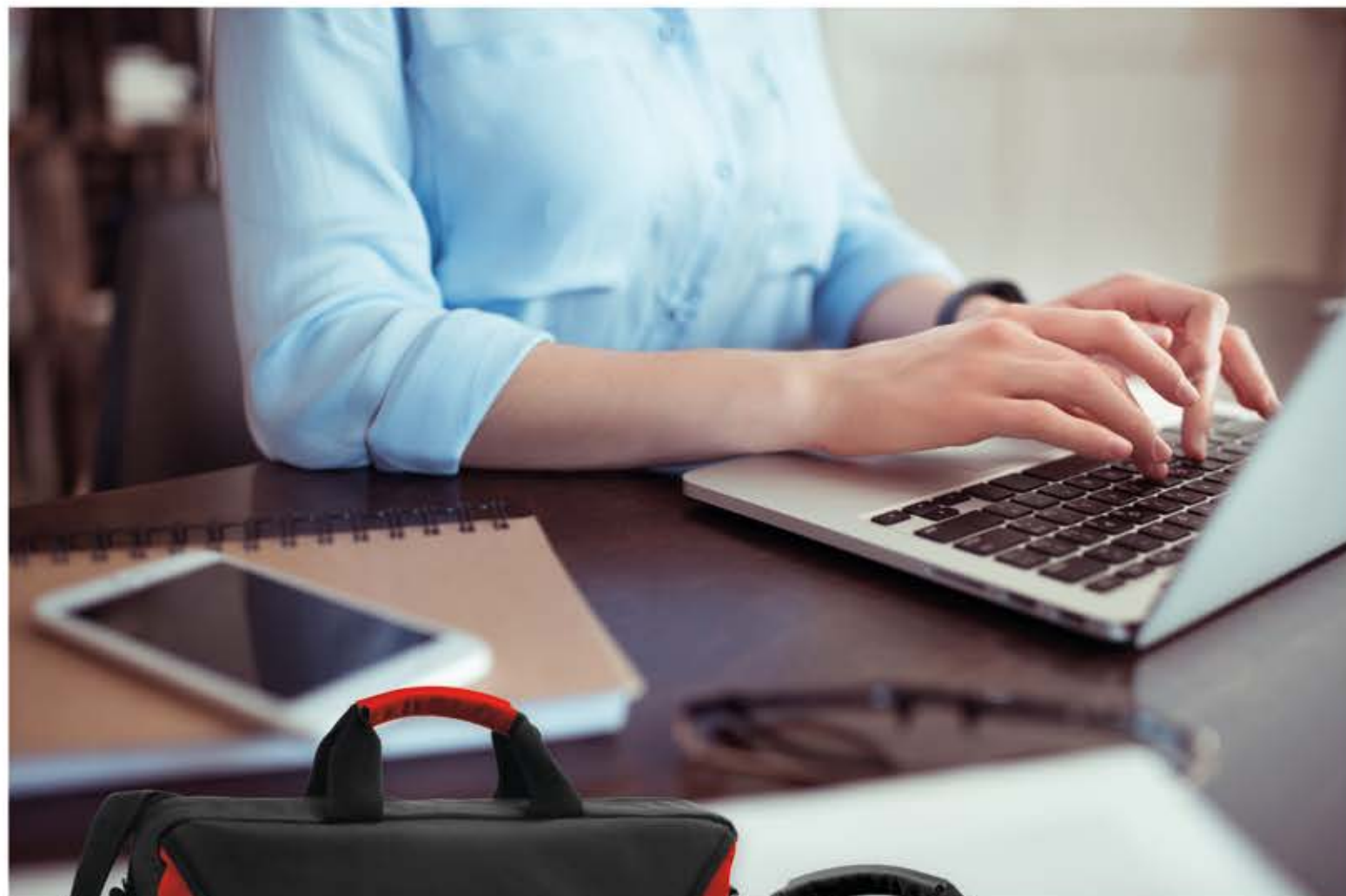

60039 *ureni*

Borsa portadocumenti con tracolla regolabile | Conference bag with adjustable shoulder strap | Bolso portadocumentos con correa regulable | Sac portadocuments avec bandoulière réglable
 Poliestere 600D | Polyester 600D | Poliéster 600D | Polyester 600D

40 x 30 x 10 cm 🚰 S78 | TR9 12 x 6 cm 📦 20/40



.18



.29



60004 *galeno*

Borsa portadocumenti, manici e tracolla | Document bag with front vertical zip | Portadocumentos con bolsillo frontal y bandolera | Sac porte-documents, poignès et bandoulière
 Poliestere 600D | Polyester 600D | Poliéster 600D | Polyester 600D

37 x 29 x 8,5 cm 🚰 S78 | TR9 15 x 8 cm 📦 1/30



60006 *efrest*

Borsa portadocumenti | Document bag | Portadocumentos con asa corta | Sac portadocuments
 Poliestere 600D | Polyester 600D | Poliéster 600D | Polyester 600D

38 x 28 x 10 cm 🚰 S78 | TR9 15 x 10 cm 📦 1/40



60092 *siuntio*

Borsa meeting, interno foderato | Multifunction bag with lined interior | Maletín multiusos con interior forrado | Sacoche multifonctions avec intérieur doublé.
 Poliestere 600D | Polyester 600D | Poliéster 600D | Polyester 600D

37 x 27 x 5 cm 🚰 S78 | TR9 10 x 10 cm 📦 50



60102 *gryazi*

Borsa portadocumenti | Conference bag | Bolso portadocumentos | Sac portadocuments

Poliestere 420D | Polyester 420D | Poliéster 420D | Polyester 420D

34 x 27 x 10 cm 🚰 S78 | TR9 15 x 8 cm 📦 5/50



.01

60094 *palmer*

Borsa a tracolla, compartimento per tablet | Shoulder bag with tablet compartment | Maletín bandolera con compartimento para tablet | Sac à bandoulière avec compartiment pour tablette tactile.
Nylon 800D

24 x 30 x 6 cm S7 | TR9 5 x 5 cm 40



.13



65506 *fikri*

Borsa multitasche con tracolla regolabile | Multifunction shoulder bag | Bandolera con bolsillos | Sac multipoches avec bandoulière réglable
Poliestere 600D | Polyester 600D | Poliéster 600D | Polyester 600D

18 x 14 cm S78 | TR3 5 x 5 cm 1/100



.04

17135 *hupp*

Borsa tracolla | Shoulder bag | Bolso Bandolera | Sac avec bandoulière Non-Woven 100 gr/m2

26 x 33 x 6 cm S98 | TR18 15 x 15 cm 25/250



.08

17011 *holly*

Borsa a tracolla | Shoulder bag | Bandolera | Sac avec bandoulière Non-Woven

36,5 x 10,5 x 33,5 cm S98 | TR8 15 x 15 cm 50/200



.08

17015 *janna*

Borsa a tracolla | Shoulder bag | Bolso bandolera | Sac avec bandoulière Non-Woven

37 x 30 x 9 cm S98 | TR8 5 x 15 cm 50/200



.13

17094 *pandora*

Borsa a tracolla | Shoulder bag | Bolso bandolera | Sac avec bandoulière Non-Woven

35 x 39 x 6 cm S98 | TR8 15 x 15 cm 50/300



.19

60080 *harriet*

Borsa portadocumenti | Conference bag | Bolso portadocumentos | Sac porte-documents Non-Woven

38 x 30 cm S78 | TR7 15 x 10 cm 250



.01



65508 *patron*

Borsello multitasche con tracolla regolabile | Multi pockets shoulder bag | Bandolera multi-bolsillo | Sacoche multipoches avec bandoulière réglable
Poliestere 600D | Polyester 600D | Poliéster 600D | Polyester 600D

10 x 11 x 8 cm S78 | TR3 4 x 4 cm 10/200



.23



41343 *sakata*

Tracolla portaoggetti | Shoulder bag - purse | Bolso bandolera | Sac bandoulière porte-objets
Poliestere 600D | Polyester 600D | Poliéster 600D | Polyester 600D

10,5 x 13,5 cm S98 | TR3 5 x 5 cm 1000



.06

60058 *zenon*

Borsa da congressi | Conference bag | Bolso congresos | Sac congrès Non-Woven

37,5 x 26 cm S78 | TR7 10 x 8 cm 1/50

SHOULDER bag



60106 *stavropol*

Borsa portacomputer in tessuto jeans grigio | Computer bag | Bolsa para laptop | Sac porte ordinateur en tissu
 Poliestere 600d | Polyester 600d | Poliéster 600d | Poliéster 600d

37,5 x 29 x 8 cm S100 | TR10 8 x 8 cm 1/20



64169 *serchio*

Borsa portadocumenti | Conference bag | Bolsa portadocumentos | Sac porte-documents
 Poliestere 600D | Polyester 600D | Poliéster 600D | Polyester 600D

29,5 x 9 x 38 cm S78 | TR9 15 x 10 cm 50



60111 *fuji*

Borsa portadocumenti | Document Case | Maletin portadocumentos | Sac porte-documents
 Poliestere 600D | Polyester 600D | Poliéster 600D | Polyester 600D

36 x 28 x 4 cm S78 | TR9 10 x 10 cm 1/30



60116 *nuuk*

Tracolla portadocumenti con sezioni per le penne | Briefcase shoulder bag | Mochila portadocumentos | Sac bandoulière porte-documents
 Non-woven

36,2 x 30 x 9 cm S78 | TR6 15 x 15 cm 100



60029 *lubbe*

Borsa portadocumenti con varie tasche e tracolla | Document bag with inside pockets and strap | Portadocumentos con bolsillos y correa regulable | Sac porte-documents avec plusieurs poches et bandoulière réglable
 Nylon

39,5 x 29,2 x 7,5 cm S78 | TR9 10 x 10 cm 25/50



60061 *aros*

Portadocumenti con zip | Zipped document case | Portadocumentos con cremallera | Porte documents avec fermeture éclair
 Non-Woven

34,5 x 25,5 S78 | TR7 15 x 10 cm 10/400



60122 *klinty*

Borsa tracolla per sublimatico | Sublimation bag | Portadocumentos por sublimatico | Porte-document pour sublimation
 Microfibra | Microfiber | Microfibra | Microfibre

40 x 9 x 29 cm S78 10 x 10 cm | SP31 25 x 20 cm | TR9 10 x 10 cm 50

BACKPACK *bag*

Cinghia per aggancio al trolley
With carry-on trolley strap
Correa trasera para agarre a la maleta
Attache pour trolley

Tasca antitaccheggio
Anti-Theft pocket
Compartimento antirrobo
Poche anti-vol



Connettore USB per Power Bank
USB connector for Power Bank
Conector USB para Power Bank
Connection USB au Power Bank

Cerniera waterproof
Waterproof zipper
Cremallera waterproof
Fermeture waterproof

Porta USB
USB port
Puerto USB
Port USB

64196 **sinnerli**

Zaino con tasca antisaccheggio sulla schiena. Cavo USB incluso. Schiena e spalline rinforzati. | Backpack with anti-theft pocket on the back. USB cable included. Padded back and shoulder straps. | Mochila con bolsillo antirrobo en la espalda. Cable USB incluido. Espalda y asas reforzadas. | Sac à dos coloré anti-vol sur le dos. Cable USB inclus. Dos et bretelles renforcés. Fermeture éclair waterproof
Poliestere | Polyester | Poliéster | Polyester

42 x 35 x 16,5 cm

travel & bags
482

Zaino
multitasking

Porta USB
Connettore a Power Bank
Cerniera waterproof
Tasca antitaccheggio
Cerniera antitaccheggio
Cinghia per aggancio al trolley





.01



60091 *milas*

Zaino portacomputer | Laptop bag | Bolsa de portátil | Sac porte-ordinateur
Poliestere 600D | Polyester 600D | Poliéster 600D | Polyester 600D

33 x 15 x 45 cm S100 | TR10 10 x 10 cm 20



.05



.01



64534 *himmelsk*

Zaino con collegamento USB. Schiena e spalline rinforzate | Backpack with USB connection. Reinforced back and shoulder straps. | Mochila con conexión USB. Asas y espalda reforzadas | Sac à dos avec connection USB. Dos et bretelles rembourrés
Nylon | Nylon | Nylon | Nylon

45 x 30 x 20 cm 10

64201 *skojig*

Zaino porta PC con doppio scomparto, tasca esterna verticale e 2 tasche a rete laterali | Backpack for PC with double compartment, vertical pocket and 2 web pockets on the sides | Mochila para PC con compartimento doble, bolsillo vertical y 2 bolsillos de red a los lados | Sac à dos porte ordinateur avec double compartiment, poche externe verticale et 2 poches perforées laterales

Poliestere | Polyester | Poliéster | Polyester

41 x 23 x 15 cm





64191 **chenzia**

Zaino | Backpack | Mochila | Sac à dos avec 2 poches externes et compartiment interne. Design elegant et pratique.
 Polyester 500D | Polyester 500D | Poliéster 500D | Polyester 500D
 30 x 12 x 45 cm 📏 S100 | TR10 10 x 10 cm 📦 1/20



64192 **giove**

Zaino portacomputer con schienale rinforzato | Laptop backpack | Mochila para portátil | Sac à dos multipoches.
 Woven Nylon 1200D | Woven Nylon 1200D | Woven Nylon 1200D | Woven Nylon 1200D
 34 x 18 x 48 cm 📏 S100 | TR10 10 x 10 cm 📦 1/20



64193 **citrine**

Zaino portacomputer con schienale rinforzato | Backpack | Mochila | Sac à dos multipoches.
 Nylon 210 Woven | Nylon 210 Woven | Nylon 210 Woven | Nylon 210 Woven
 32 x 18 x 43 cm 📏 S100 | TR10 10 x 10 cm 📦 1/20



64157 **hindu**

Zaino | Backpack | Mochila | Sac à dos
 44 x 25 x 32,5 cm 📏 S100 | TR10 10 x 10 cm 📦 20



64187 *grossotto*

Zaino portacomputer con schienale rinforzato | Backpack | Mochila | Sac à dos multipoches.
Poliestere

32 x 33 x 16 cm 🚰 S100 | TR10 10 x 10 cm 📦 1/20



.01



64535 *voxnan*

Zaino portacomputer fino a 15,6". Maniglia metallica | Laptop backpack up to 15,6" with metal handle | Mochila para ordenador de hasta 15,6" con asa metálica | Sac à dos pour ordinateur jusqu'à 15,6". Poignée métallique
Poliestere | Polyester | Poliéster | Polyester

32 x 12 x 42 cm 🚰 S100 12 x 5 cm 📦 25



.01



.05

.13



.08



.03



.01

.05

64174 *abinsk*

Zaino | Backpack bag | Bolso mochila | Sac à dos
Poliestere 840D | Polyester 840D | Poliéster 840D | Polyester 840D

28 x 38 x 6 cm 🚰 S100 | TR10 10 x 10 cm 📦 1/20

64197 *kivik*

Zaino con tasta imbottita per PC portatile. Schiena e spalline rinforzate | Backpack with padded pocket for PC. Back and shoulder straps reinforced | Mochila con bolsillo acolchado para PC portátil. Parte trasera y cintas acolchadas | Sac à dos avec poche rembourré pour ordinateur portable. Dos et bretelles renforcés
Nylon 600D | Nylon 600D | Nylon 600D | Nylon 600D

41 x 29 x 18 cm 🚰 S100 📦 20



.07



.19



.01



.23

.08

60019 *heilko*

Portadocumenti con scompartimento per biglietto di visita e zip | Zipped document case with business card holder | Portadocumentos con cremallera y ventanilla para tarjeta | Porte-documents avec fermeture éclair et poche pour cartes de visite
Nylon

34,5 x 25,5 x 0,5 cm S76 | TR7 10 x 10 cm 1/200

60090 *nashi*

Portadocumenti con cerniera | Zipped document case | Portadocumentos con cremallera | Porte documents avec fermeture éclair
Poliestere 600D | Polyester 600D | Poliéster 600D | Polyester 600D

36,5 x 28 cm S76 | TR7 15 x 10 cm 100



.86



.08



.85



.88

.85

.01



.23

.01



.88

60086 *ghianda*

Portadocumenti | Document folder | Porta documentos | Porte-Documents
Soft Shell | Soft Shell | Soft Shell | Soft Shell

38 x 27 cm S78 | TR9 10 x 10 cm 40

60040 *lissan*

Borsa computer | Laptop bag | Funda Ordenador | Sac pour ordinateur
Soft Shell

28 x 22 x 2,5 cm S78 | TR9 10 x 10 cm 10/80

60130 *garfield*

Borsa per computer con tasca esterna con zip. | Laptop bag with shoulder strap | Bolsa para portátil con asa larga | Sac pour ordinateur avec poche externe avec zip.
Polyester 300D | Polyéster 300D | Poliéster 300D | Polyester 300D

37 x 5 x 26 cm S10 | TR11 8 x 8 cm 10/20



.01



.27

.01

60013 *rene*

Borsa portadocumenti/portacomputer, con manici e tracolla | Conference bag with many compartments and adjustable shoulder strap | Cartera portadocumentos con compartimento interior acolchado para ordenador | Sac porte-documents/porte ordinateur, avec hanches et bandoulière
Microfibra | Microfiber | Microfibra | Microfibre

41 x 33 x 10 cm S100 | TR10 12 x 6 cm 1/20

60056 *samirah*

Borsa portadocumenti con tracolla regolabile | Conference bag with adjustable shoulder strap | Bolso portadocumentos con correa regulable | Sac porte-documents avec bandoulière réglable
Poliestere 600D | Polyester 600D | Poliéster 600D | Polyester 600D

30 x 34 x 7 cm S100 | TR10 7 x 7 cm 5/25



.03

64150 *temryuk*

Zaino in tessuto jeans grigio | Backpack | Mochilla por laptop | Sac à dos en tissu
Poliestere 600d | Polyester 600d | Poliéster 600d | Poliéster 600d

37 x 43 x 12 cm S100 | TR10 8 x 8 cm 1/20



.08

64182 *jeans*

Zaino in tessuto jeans | Backpack with denim material | Mochilla de tela
mezclilla | Sac en tissu denim

Poliestere 600d | Polyester 600d | Poliéster 600d | Poliéster 600d

27,5 x 12 X 39 cm S78 | TR9 15 x 8 cm 1/50



.08

.17

.23

.07

.01

64532 *bittergurka*

Zaino con spalline e schienale imbottiti. Tasca frontale. | Backpack with padded back
and shoulder straps | Mochila con espalda y asas reforzadas | Sac à dos avec bretelles
et appui dorsal rembourrés. Poche frontale

Poliestere 600D | Polyester 600D | Poliéster 600D | Poliéster 600D

28 x 38 x 12 cm S78



.08

.01

.23

64204 *aguadilla*

Zaino con uscita per auricolari | Backpack with outlet for earphones | Mochila con
salida para auriculares | Sac à dos avec sortie pour écouteurs

Poliestere 600D | Polyester 600D | Poliéster 600D | Poliéster 600D

31 x 13,5 x 43 cm S78 10 x 10 cm 30



.08

.23

.03

DENIM
bag

65125 *rotolo*

Borsa in tessuto jeans | Bag with denim material | Bolsa de tela mezclilla
| Sac en tissu denim

Poliestere 600d | Polyester 600d | Poliéster 600d | Poliéster 600d

Ø 24 x 52 cm S100 | TR10 12 x 12 cm 1/50



65044 *uya*

Trolley con manico estendibile | Trolley with extendable handle | Trolley con asa extensible | Trolley avec poignée rentrante
 Poliestere 600D | Polyester 600D | Poliéster 600D | Polyester 600D

54 x 27 x 25,5 cm S100 | TR11 10 x 10 cm 10



.01

66059 *bangweulu*

Zaino trolley multitasche con porta notebook | Trolley backpack with several pockets and compartments suitable for laptop | Trolley mochila. Múltiples bolsillos incluso para portátil acolchado | Trolley sac a dos. Múltiples poches et compartiments matelassés pour ordinateur portable
 Poliestere 1680D | Polyester 1680D | Poliéster 1680D | Polyester 1680D

53 x 35 x 23 cm S16 15 x 10 cm 1 / 4



.08

.17

.01

.06

.05

64164 *dee*

Trolley | Trolley bag | Bolsa viaje trolley | Chariot de commissions
 Poliestere 600D | Polyester 600D | Poliéster 600D | Polyester 600D

52 x 27 x 27 cm S100 10 x 10 cm 6



.08

.01

.05

65017 *giuggiola*

Trolley | Trolley bag | Bolsa viaje trolley | Chariot de commissions
 Poliestere 600D | Polyester 600D | Poliéster 600D | Polyester 600D

51 x 26 x 26 cm S100 10 x 10 cm 10

66080 *pinnig*

Zaino trolley a 6 tasche con manico singolo estraibile. Schiena e spalline rinforzate.
 | Backpack trolley with 6 pockets and one top handle. Back and shoulder strips reinforced.
 | Mochila trolley con 6 bolsillos y manillar extraíble. Espalda y asas reforzadas.
 | Sac trolley avec 6 poches avec poignée télescopique. Dos et bretelles renforcés.

Poliestere 1680D | Polyester 1680D | Poliéster 1680D | Polyester 1680D

23 x 50 x 29 cm S10 10 x 10 cm 4



.01





.01

66093 *oumbärliq*

Trolley da viaggio semirigido multitasche, alta qualità, manico telescopico estraibile. 5 scomparti tra i quali 1 con tasca porta PC, 1 con fascicolatore. Varie tasche interne e 2 esterne | Trolley with several pockets, premium quality, telescopic handle. 5 compartments, 1 of them for PC, 1 for documents. With many pockets inside and 2 pockets in the outside | Trolley de cabina | Trolley de viaje semirigido con numerosos bolsillos, de alta calidad, asa telescópica extraíble. 5 compartimentos, de los cuales 1 para el PC y otro para documentos. Con muchos bolsillos en su interior y 2 en el exterior. Poliestere | Polyester | Poliéster | Polyester

23 x 36 x 41 cm

TRAVELLING *around*



.01



.01



.01



66988 *amex*

Trolley con doppia tasca | Trolley with double front pockets | Trolley con doble bolsillo | Trolley avec double poche
 Poliestere 600D | Polyester 600D | Poliéster 600D | Polyester 600D

38 x 52 x 21 cm S16 | TR11 5 x 5 cm

1/1

66008 *pearl*

Trolley ultra leggero | Extra light trolley | Trolley Super Illeggero | Trolley ultra léger
 Poliestere 600D | Polyester 600D | Poliéster 600D | Polyester 600D

35 x 22 x 47 cm S16 8 x 3 cm 1/1

66058 *zambia*

Trolley ultraleggero con 4 ruote | Lightweight 4-wheeled trolley | Trolley ligero de 4 ruedas giratorias | Valise trolley léger avec 4 roues pivotantes
 Poliestere | Polyester | Poliéster | Polyester

56 x 38 x 21 cm S16 15 x 12 cm 1

TROLLEY LAPTOP holder

Travel & bags

498



.08



.01



.01

66039 ines

Trolley con comparto per computer | Trolley bag with laptop compartment | Trolley con compartimento para ordenador | Trolley avec compartiment pour ordinateur portable

Poliestere 600D | Polyester 600D | Poliéster 600D | Polyester 600D

43 x 35 x 18 cm 16 x 10 x 10 cm 1/4

66024 mengibinos

Trolley porta computer - bagaglio a mano | Trolley laptop holder bag/ hand luggage | Maleta de mano | Bagage à main

Poliestere 600D | Polyester 600D | Poliéster 600D | Polyester 600D

2 x 17 x 35 cm 16 x 5 x 5 cm 1/4



66092 ordning

Trolley da viaggio semirigido con vano porta pc, manico telescopico estraibile, 1 tasca esterna | Trolley with compartment for PC, telescopic handle. External pocket | Trolley semirígido con compartimento para PC. Asa telescópica y bolsillo externo |

Poliestere | Polyester | Poliéster | Polyester

20 x 36 x 41 cm



Rolley

.32

66049 *virgie*

Trolley 4 ruote | Light trolley with 4 wheel | Trolley con 4 ruedas | Trolley avec 4 roues
ABS

52 x 35 x 20 cm 🧴 D9 📦 1



.08



.02

.01

.05

66009 *clementina*

Trolley con 2 ruote | Trolley with 2 wheels | Trolley con 2 ruedas | Trolley 2 Roues
ABS

46 x 40,5 x 19 cm 🧴 S16 10 x 2 cm 📦 2

66094 *yddingen*

Trolley da cabina con lucchetto numerico | Cabin trolley with numerical padlock | Trolley de cabina con candado numérico | Trolley cabine avec cadenas numérique
ABS | ABS | ABS | ABS

33 x 20 x 55 cm 🧴 4 x 1 cm 📦 1



.02





.23



.23



.07

.05

.08

64131 *brighton*

Pochette portascarpe con manico | Shoe Tote | Funda para zapatos | Sac porte-chaussures

Poliestere 420D | Polyester 420D | Poliéster 420D | Polyester 420D

35 x 17,5 x 16 cm 🚰 S78 | TR9 10 x 5 cm 📦 100



.17

.06

.08

.01

64502 *aoki*

Sacca portascarpe | Shoe bag | Funda para zapatos | Sac rangement chaussures

TNT

42 x 20 x 14,5 cm 🚰 S76 | TR7 10 x 4 cm 📦 10/400



.05



.01



.08



.01



.08



.05



.07

.23

.01

.17



.01

66006 *guatemala*

Portabiti | Suit holder | Porta trajes | Housse à vêtements
No-Women | No-Women | No-Women | No-Women

60 x 100 cm 🚰 S38 | TR2 10 x 10 cm 📦 10/100

64037 *pueblo*

Trolley con manico a scomparsa | Trolley | Trolley con asa retráctil | Trolley avec poignée rentrante
Poliestere 600D | Polyester 600D | Poliéster 600D | Polyester 600D

27 x 53 x 27 cm 🚰 S100 | TR11 10 x 10 cm 📦 1/10

66021 *eneas*

Trolley con manico a scomparsa | Trolley | Trolley con asa retráctil | Trolley avec poignée rentrante
Nylon 600D

41 x 59 x 17 cm 🚰 S16 | TR11 10 x 10 cm 📦 1/1

64159 *danube*

Trolley pieghevole | Trolley | Trolley | Chariot de commissions pliant
Poliestere | Polyester | Poliéster | Polyester

50 x 20 x 35 cm 🚰 S16 10 x 10 cm 📦 6



41044 **melis**

Custodia per documenti di viaggio | Travel document case | Portadocumentos viaje | Porte-documents de voyage
PVC | PVC | PVC | PVC

21,8 x 10,3 cm S2 4 x 2 cm 150

TRAVEL DOCUMENT holder



41039 **dandi**

Custodia per passaporto | Passport case | Funda pasaporte | Étui passeport
PVC | PVC | PVC | PVC

10 x 13,8 cm S2 4 x 2 cm 300



60121 *adler*

Portadocumenti da viaggio | Travel briefcase | Portadocumentos de viaje | Porte documents de voyage
 Poliestere 600D | Polyester 600D | Poliéster 600D | Polyester 600D
 12 x 24 cm 🌧️ S2 | TR1 4 x 4 cm 📦 1/100



60068 *helio*

Portadocumenti da viaggio | Travel document holder | Portadocumentos de viaje | Porte documents de voyage
 Poliestere 600D | Polyester 600D | Poliéster 600D | Polyester 600D
 25 x 13 cm 🌧️ S2 | TR1 4 x 4 cm 📦 5/200



60131 *knoxhult*

Portadocumenti di viaggio con finestra trasparente | Travel documents holder with window | Cartera para documentación de viaje con ventana transparente | Porte documents de voyage avec poche transparente
 Poliestere 420D | Polyester 420D | Poliéster 420D | Polyester 420D
 27 x 14,5 cm 🌧️ S2 | TR1 4 x 4 cm 📦 200

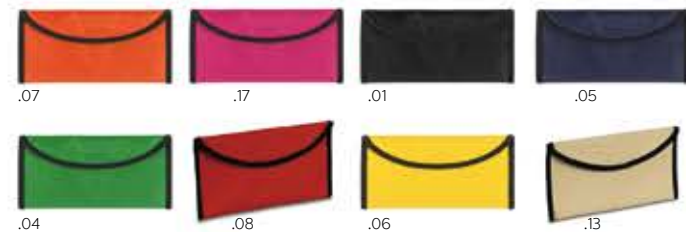

60132 *karesta*

Portadocumenti da viaggio con velcro | Travel documents holder with velcro | Cartera para documentación de viaje con velcro | Portedocumentos de voyage avec velcro
 Poliestere 300D | Polyester 300D | Poliéster 300D | Polyester 300D
 27 x 13 cm 🌧️ S2 | TR1 4 x 4 cm 📦 400



69017 *alp*

Portanome per bagaglio | Luggage tag with paper card | Identificador equipaje | Étiquette d'identification pour bagage
 Plastica | Plastic | Plástico | Plastique
 5,5 x 9,5 x 0,4 cm 🌧️ T6 | UV19 4 x 4 cm 📦 100/1000



.32



.03



69040 *ashley*

uggage tag | identificador equipaje | Étiquette d'identification pour bagage
 Alluminio | Aluminium | Aluminio | Aluminium
 8 x 4,2 x 0,2 cm 🌧️ T7 | L16 4 x 1,5 cm
 📦 500

69007 *locke*

Portanome per bagaglio | Luggage tag with paper card | Identificador equipaje | Étiquette d'identification pour bagage
 Plastica | Plastic | Plástico | Plastique
 7,5 x 6,2 x 0,3 cm 🌧️ T6 4 x 2 cm
 📦 100/500



.02

69002 *hilger*

Portanome per bagaglio | Luggage tag with paper card | Identificador equipaje | Étiquette d'identification pour bagage
 Plastica | Plastic | Plástico | Plastique
 11 x 6 cm 🌧️ T6 | UV2 11 x 6 cm
 📦 1/500

TRAVEL *set*



travel & bags

508



.03

69025 *gubbio*

Set viaggio con cuscino poggiatesta, mascherina, tappi per orecchie e calzini, custodia inclusa | Travel set with neck pillow, sleeping mask, earplugs and socks | Set de viaje con almohadilla, antifaz, tapones para oídos y calcetines. Incluye funda. | Set de voyage incluant un coussin, un masque, des bouchons à oreilles et des chaussettes
Poliestere 190T | Polyester 190T | Poliéster 190T | Poliéster 190T

15 x 20 cm S93 7 x 7 cm 25/100



.03

69023 *trenton*

Set da viaggio con cuscino appoggiatesta, tappi per orecchie e mascherina | Travel set (3 accessories) | Set de viaje (3 accesorios) | Set de voyage (3 accessoires)
Microfibra | Microfiber | Microfibra | Microfibre

17 x 11 cm S93 5 x 3 cm 100



.03

69008 *rhys*

Cuscino poggiatesta gonfiabile da viaggio | Inflatable travel pillow | Almohadilla hinchable de viaje | Coussin appui-tete de voyage, gonflable
Vellutino | Velvet | Terciopelo | Velours

41 x 25 x 0,2 cm S96 5 x 5 cm 30/120



.08

.23

.02

.01

.17

.06

69026 *heliodor*

Set da viaggio, 2 pezzi | Travel set, 2 accessories | Set de viaje, 2 accesorios | Set de voyage, 2 accessoires
Microfibra, EVA | Microfiber, EVA | Microfibra, EVA | Microfibre, EVA

19 x 9 cm S96 5 x 5 cm 1/500



.01

43839 *bangkok*

Set relax da viaggio con mascherina, tappi per orecchie e spazzola | Relax travel set (eyemask, ear plugs, comb) with bag | Kit de viaje relax | Set relax de voyage
Cotone | Cotton | Algodón | Coton

mascherina 18 x 8 cm - borsa 17,5 x 11 cm - spazzolino 2,5 x 2 x 10,7 cm
S93 5 x 5 cm 400



.21

43109 *vihti*

Kit viaggio conforme alle norme di sicurezza aeroportuali, in trousse trasparente con zip, 3 bottiglie (2 x 65 ml e 60 ml), 1 spruzzo (80 ml) e 1 imbuto | Travel kit in zipped transparent case with 3 jars (2 x 65 ml and 60 ml), 1 vaporizer (80 ml) and 1 funnel | Kit de viaje conforme a las normas de seguridad de los aeropuertos, en estuche transparente con zip, incluye 3 envases (2 x 65 ml y 60 ml), 1 vaporizador (80 ml) y 1 embudo | Kit de voyage conforme aux normes de sécurité aéroportuaires, dans trousse transparente avec fermeture éclair inclus - flacons (2 x 65 ml et 60 ml), 1 vaporisateur (80 ml) et 1 entonnoir
PVC

19 x 15,5 x 4 cm S93 7 x 2 cm 96



.06

69048 *merrit*

Tappi per orecchie, confezione individuale | Earplugs, individual case | Tapones oídos, en caja individual | Bouchons d'oreilles en boîte individuelle
EVA, PVC

3,5 x 3,5 x 1,5 cm T6 2 x 2 cm 200/2000



.01

69015 *yamato*

Paraocchi | Eyeshade | Antifaz de viaje | Oeillères
Microfibra | Microfiber | Microfibra | Microfibre

18,5 x 9 cm S95 8 x 3 cm 100/2000

travel & bags

509



26401 **gattatico**

Adattatore universale per prese e usb con scatola | Universal adapter with case and usb | Set adaptador universal de viaje con usb | Adaptateurs universels de voyage avec usb
Plastica | Plastic | Plástico | Plastique

6 x 6 x 5 cm T8 | UV3 4 x 2,5 cm 100



43072 **hilmi**

Presa adattatore universale da viaggio | Travel plug, translucent plastic | Adaptador para enchufes de la Unión Europea y Suiza | Prise adaptateur universel de voyage
Plastica | Plastic | Plástico | Plastique

ø 4,5 x 8,5 cm T7 2 x 0,8 cm 100

ADAPTORS *universal*



43115 **andelle**

Set prese da viaggio | Set of socket adaptors | Juego adaptador enchufes | Set prises de voyage
Plastica | Plastic | Plástico | Plastique

ø 4,5 x 8,5 cm T7 2 x 0,8 cm 100



43057 **riquis**

Adattatore | Plug adapter | Adaptador | Adaptateur PVC

5 x 7,4 x 4 cm T7 | UV3 3 x 1 cm 100

26182 **branford**

Adattatore universale per prese con scatola | Universal adapter with case | Set adaptador universal de viaje | Adaptateurs universels de voyage
Plastica | Plastic | Plástico | Plastique

6 x 6 x 5 cm T8 | UV3 4 x 2,5 cm 100



26261 **wantipa**

Adattatore con 2 Uscite USB. 2100 mA. Adatto per USA, Europa, Asia, UK | Plug adapter with 2 USB Outputs. 2100 mA. Suitable for USA, Europe, Asia, UK | Adaptador con 2 Salidas USB. 2100 mA. Ideal por USA, Europa, Asia, Reino Unido | Adaptateur avec 2 Sorties USB. 2100 mA. USA, Europe, Asie, Royaume-Uni
Plastica | Plastic | Plástico | Plastique

4,5 x 6,1 x 5,6 cm T7 | UV3 3 x 2 cm 50 / 100



26394 **gaiarine**

Adattatore da viaggio con doppia presa usb | Universal plug adapter | Adaptador de enchufes universal | Adaptateur de voyage universel avec 2 USB
Plastica | Plastic | Plástico | Plastique

5 x 7,4 x 4 cm T7 | UV3 3 x 1 cm 100





72005 **tucson**

Bilancia pesabagagli Max 40 kg | Baggage Scale Max 40 kg | Bascula para equipaje Max 40 kg. Pila boton incluida | Pèse-Bagages Max 40 kg
Plastica | Plastic | Plástico | Plastique

10 x 18 x 3,7 cm T7 2 x 1 cm 50/150

BAGGAGE

accessorise



69102 **nichelino**

Lucchetto per valigia con combinazione | Combination lock for bag | Candado para equipaje | Cadenas pour valise avec combinaison
Metallo | Metal | Metal | Métal

2 x 6,5 cm T14 | L2 2 x 0,8 cm 500



① 42027 **rudo**

Set puliscscarpe, 6 pezzi in scatola di latta (include cera, calzascarpe, spazzola e panno in scamosciato) | Polish shoes set in tin, 6pcs (includes wax, shoehorn, brush and shammy cloth) | Set limpiacalzado con cera, calzador, cepillo y gamuza | Kit nettoyage chaussures
Metallo | Metal | Metal | Métal

9,8 x 5,6 cm S4 | L10 Ø 5 cm 20/100

③ 42016 **ilia**

Pulisci scarpe | Shoes cleaner | Limpia calzado | Kit nettoyage chaussures
Nylon

Ø 5,5 cm S93 5 x 2 cm 1/720

② 43131 **galliera**

Calza scarpe | Shoehorn | Calzador | Chausse-pied
Plastica | Plastic | Plástico | Plastique

25 x 4,3 x 0,5 cm T1 | UV1 5 x 2 cm 50/300

④ 42020 **theda**

Pulisci scarpe | Shoe sponge | Limpia calzado | Eponge pour nettoyage chaussures
Plastica | Plastic | Plástico | Plastique

Ø 5,5 cm T1 | UV1 Ø 4 cm 1/720

CHILDREN

inspire IMAGINATION:

Matite colorate, astucci, pastelli a cera e set scuola anche in materiali ecologici. Penna a sfera, matite flessibili, quadernetti e block notes. Giocattoli, peluche, porta chiavi e porta foto.

514 - 563

bimbi - children - niños - enfants

96052 *svein*

Matita temperata con gomma | Sharpened pencil with eraser | Lapiz afilado con goma | Crayon avec gomme, taillé
Legno | Wooden | Madera | Bois

Ø 0,7 x 19,1 cm | T1 | UV1 6 x 0,5 cm | 100/2400



96133 *clivia*

Matita temperata con gomma | Sharpened pencil with eraser | Lápiz afilado con goma | Crayon avec gomme, taillé
Legno | Wooden | Madera | Bois

Ø 0,7 x 19,1 cm | T1 | UV1 6 x 0,5 cm | 12/2400

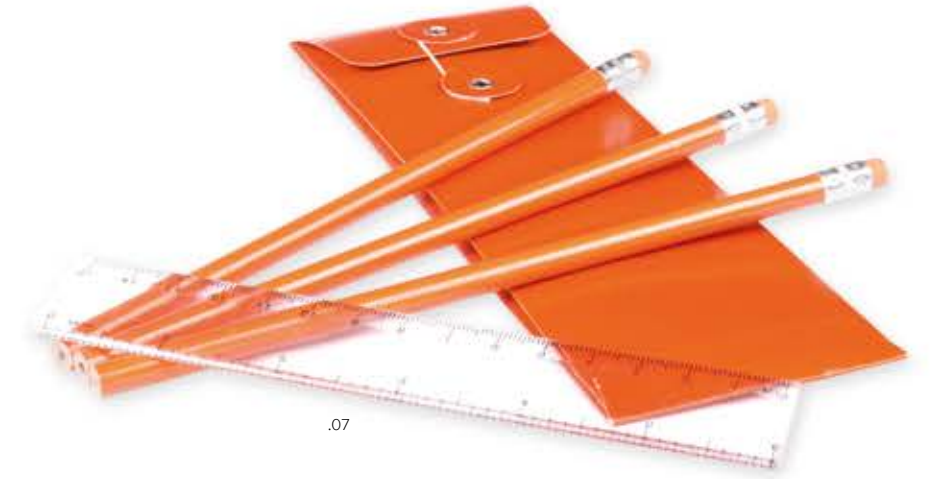
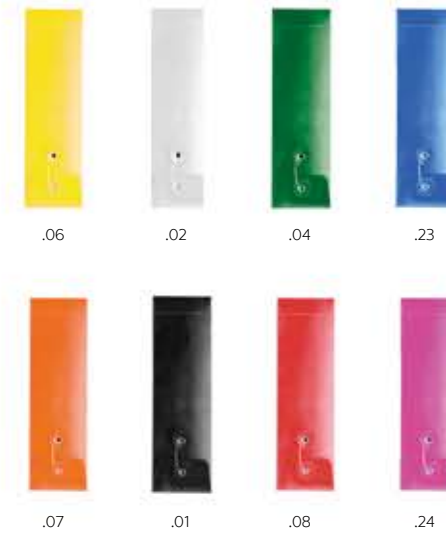

99033 *minerva*

Set scuola | School set | Set de lápices y regla | Set école
Cartone | Carton | Carton | Carton

22 x 1 x 6,5 cm T6 4 x 4 cm 20/400



96046 *stein*

Matita con gomma con anima nera | Black pencil with eraser
| Lápiz con goma, con interior negro | Crayon avec gomme
Legno | Wooden | Madera | Bois

0,7 x 19,1 cm T1 6 x 0,5 cm 60/2400

96127 *zama*

Matita | Pencil | Lápiz | Crayon
Legno | Wooden | Madera | Bois

0,7 cm x 17,7 cm T1 6 x 0,5 cm

100/2000

96147 *smask*

Set da scrittura nero con 3 matite, gomma e temperino | Writing set
with 3 black pencils, rubber and sharpener | Set de escritura con 3
lápices, goma y sacapuntas | Set écriture noir avec 3 crayons, gomme
et taille crayon

Carta, legno, plastica | Paper, wood, plastic | Papel, madera, plástico |
Papier, bois, plastique

17,7 x 4,5x 1,3 cm





.00 .02 .01

96099 *hipo*

Mini matita temperata | Sharpened small pencil | Mini lápiz con punta | Mini crayon taillé
Legno | Wooden | Madera | Bois

☞ Ø 0,7 x 9 cm ♻️ T1 | UV1 3,5 x 0,5 cm 📦 100/4800



.00

96100 *tiril*

Mini matita temperata con gomma | Sharpened mini pencil with eraser | Mini lápiz afilado con goma | Mini crayon taillé avec gomme
Legno | Wooden | Madera | Bois

☞ Ø 0,5 x 9 cm ♻️ T1 | UV1 3,5 x 0,5 cm 📦 100/2000



.06 .07 .08 .17 .04 .18 .02 .01

96900 *castanar*

Matita | Pencil | Lapiz | Crayon
Legno | Wood | Madera | Bois

☞ Ø 0,7 x 17,7 cm ♻️ T1 3 x 0,5 cm 📦 100 / 2000



.00

91137 *olathe*

Matita | Pencil | Lápiz | Crayon
Legno | Wood | Madera | Bois

☞ Ø 0,35 x 12 cm ♻️ T1 6 x 0,3 cm 📦 500/500



.00

96140 *cichorium*

Matita jumbo con temperino | Pencil with sharpener | Lápiz con sacapuntas | Crayon avec taille-crayon
Legno, plastica | Wood, plastic | Madera, plástico | Bois, plastique

☞ Ø 1,5 x 20 cm ♻️ T27 6 x 1 cm 📦 50/400



.04

.07



.05

.23



.00

96032 *frida*

Matita Non temperata | Unsharpened pencil | Lápiz | Crayon non taillé
Legno | Wooden | Madera | Bois

☞ Ø 0,7 x 19 cm ♻️ T1 | UV1 6 x 0,5 cm 📦 60/2400

96041 *eldora*

Matita con gomma. Non temperata | Pencil with eraser, unsharpened | Lápiz con goma | Crayon avec gomme, non taillé
Legno | Wooden | Madera | Bois

☞ 19 x Ø 0,7 cm ♻️ T1 | UV1 6 x 0,5 cm 📦 60/2400

96043 *leotie*

Matita in legno naturale con spazio per la stampa | Wooden pencil | Lápiz en madera natural con espacio para impresion | Crayon en bois naturel avec position pour l'imprimerie
Legno | Wooden | Madera | Bois

☞ 17cm ♻️ T2 3 x 0,7 cm 📦 100/1000



children
520

95042 philipsburg

6 matite colorate contenute in scatola di legno con righello da 20 cm | Windowed box with 6 colours pencils and ruler | 5 lápices en caja de madera con regla de 20cm | Set 5 crayons dans boîte en bois avec règle de 20cm
Legno | Wood | Madera | Bois

21 x 2,5 x 3,5 cm S2 | UV9 10 x 1,5 cm 200

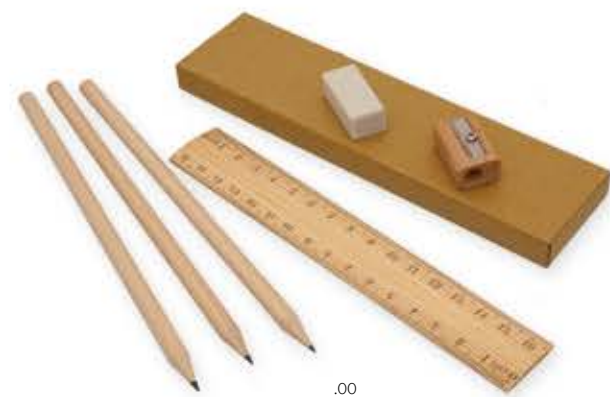

96028 deina

Set scuola, gomma, matite, temperino e righello | School set with pencils, eraser, pencil sharpener and ruler in cardboard box | Set lápices en caja de cartón con sacapuntas, goma de borrar y regla | Set écolier avec crayons, règle, gomme et taille-crayon avec boîte
Legno | Wooden | Madera | Bois

4,2 x 18 x 1 cm S2 | UV9 5 x 2 cm 20/240

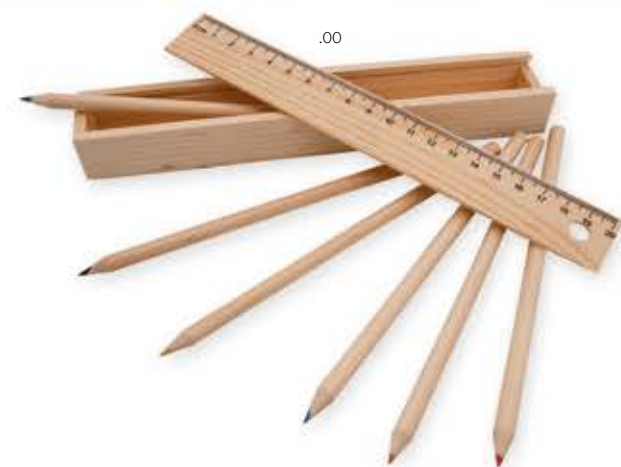

96047 mido

Set scuola ecologico | School set with pencils, eraser, pencil sharpener and ruler in ecofriendly cardboard box | Set escuela ecológico | Set écologique avec crayon, règle, gomme et taille-crayon
Carta, legno | Paper, wood | Papel, madera | Papier, bois

4,5 x 18 cm T6 5 x 1 cm 10/200

SET school



96899 charmtroll

Set scuola con gomma, penna, matita, temperino e righello | School set with rubber, ballpen, pencil, sharpener and ruler | Kit con goma, bolígrafo, lápiz, sacapuntas y regla | Set écolier avec gomme, stylo, crayon, taille-crayon et règle

Carta riciclata, plastica | Recycled Cardboard, plastic | Papel reciclado, plástico | Papier recyclé, plastique

4,5 x 17,7 x 1,5 cm S2

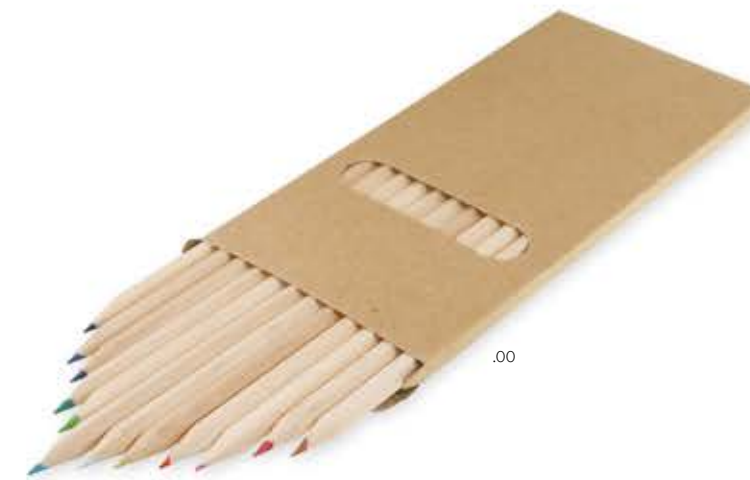

96004 *esme*

Set 12 matite lunghe colorate | Coloured pencil set in cardboard box. 12pcs | Set 12 lápices largos de colores | Ensemble 12 crayons colorés
Legno | Wooden | Madera | Bois

9,5 x 18 x 1 cm ♻️ S2 | UV9 5 x 5 cm 📦 24/240

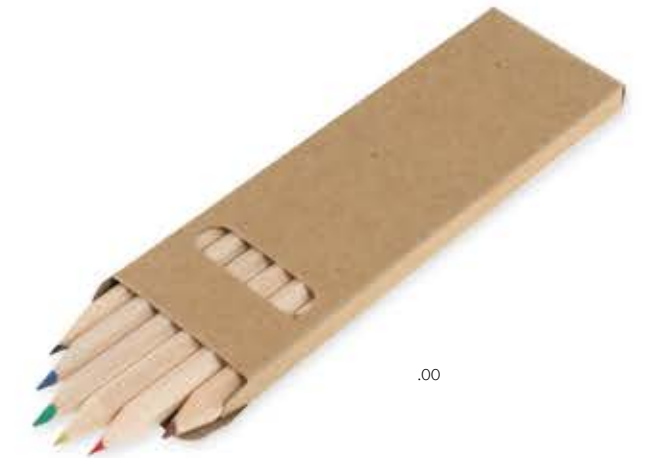

96143 *highest*

Set 6 matite lunghe colorate | Coloured pencil set in cardboard box. 6pcs | Set 6 lápices largos de colores | Ensemble 6 crayons colorés
Legno | Wooden | Madera | Bois

4,9 x 18 x 1 cm ♻️ S2 | UV9 3 x 5 cm 📦 20/200

COLOURED PENCIL set

children
523



96102 *sarajevo*

Set di 4 mini matite colorate | Four mini pencil set | Set mini lapices four | Mini crayons couleurs en boite carton
Legno | Wood | Madera | Bois

3 x 8,7 x 1 cm ♻️ T3 | UV2 3 x 3 cm

📦 48/960



96002 *nelida*

Set 6 matite corte colorate | Coloured pencil set in cardboard box. 6pcs. Small size | Set 6 mini lápices de colores | Set 6 mini crayons colorés
Legno | Wooden | Madera | Bois

4,9 x 9,3 x 0,9 cm ♻️ T3 | UV2 3 x 3 cm

📦 48/960



96006 *fe*

Set 12 mini matite corte colorate | Coloured pencil set in cardboard box. 12pcs. Small size | Set 12 mini lápices cortos de colores | Set 12 mini crayons couleurs
Legno | Wooden | Madera | Bois

9,5 x 9,3 x 1 cm ♻️ S2 | UV9 4 x 3 cm

📦 20/400



.00

96088 *moscow*

Box con 12 mini matite colorate | Mini pencil set in cylinder case | Juego de mini lapiz en caja de cilindro | Set mini crayons couleurs dans boîte cylindrique

Cartone | Carton | Carton | Carton

∅ 3,5 x 10 cm ♻️ T6 | UV2 5 x 1,5 cm 📦 250

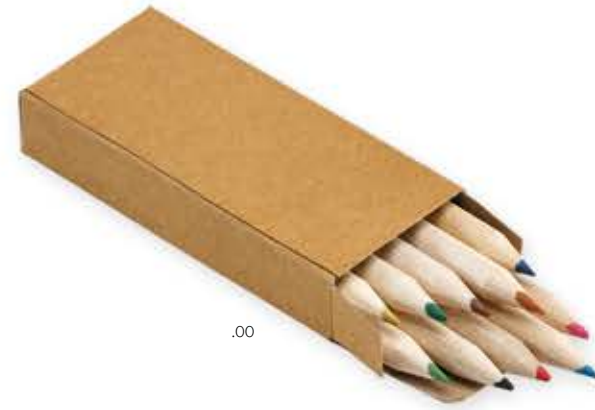

.00

96065 *nadim*

Set 10 matite corte colorate | Coloured pencil set in cardboard box. 10 pcs | Set 10 lápices largos de color es | Ensemble 10 crayons colorés

Legno | Wooden | Madera | Bois

4 x 9 x 1,5 cm ♻️ T23 | UV2 4 x 2 cm 📦 50/300



.00

96112 *stoccolma*

Set, 6 matite e temperamatite | Drawing set with 6 coloured wooden pencils | Set con 5 lápices de color y sacapuntas | Ensemble, 5 crayons et taille-crayons

Cartone | Carton | Cartón | Carton

7,4 x 9 x 1,5 cm ♻️ S2 2 x 2 cm 📦 50/400

PENES set



.02

96444 *rafael*

Set matite piatte colorate, 6 pz | Coloured flat pencil set. 6pcs. Small size | Set lápices cuadrados de colores, 6 uds. | Set crayon plats colorés, 6 pcs

Legno | Wooden | Madera | Bois

4,9 x 9,3 x 0,9 cm ♻️ S89 | UV3 6 x 0,4 cm 📦 48/960



.18

96010 *love*

Set 12 matite colorate, coperchio con temperamatite | Coloured wooden pencils with sharpener, 12pcs | Set 12 lápices de colores con sacapuntas | Set 12 crayons colorés dans leur étui cylindrique en carton et capuchon en plastique avec taille-crayon

Legno | Wooden | Madera | Bois

∅ 3,5 x 10,5 cm ♻️ T6 | UV2 4 x 1,5 cm 📦 20/200



.18

96008 *lulu*

Set 6 matite colorate, in astuccio cilindrico in cartone, coperchio in plastica con temperamatite | Coloured wooden pencils with sharpener, 6pcs | Set 6 lápices de colores con sacapuntas | 6 crayons colorés, couvercle avec taille-crayon

Legno | Wooden | Madera | Bois

∅ 2,7 x 10 cm ♻️ T6 | UV2 4 x 1 cm 📦 50/400



96090 *saint petersburg*

Set per colorare con 8 pastelli a cera e 8 fogli con illustrazioni da colorare | Set with 8 pastels and 8 colouring cards, with box | Juego de colorines con 8 lápices y 8 modelos para pintar | Set à colorier incluant 8 crayons et 8 modèles à colorier
Cartone | Carton | Carton | Carton

18 x 9 cm S2 4 x 4 cm 20/180



96027 *jago*

Set matite, pastelli e temperino | Drawing set with pencils, sharpener and pastels | Set ceras, lápices y sacapuntas | Set crayons et pastels avec taille crayons
Cartone | Carton | Cartón | Carton

Ø 4,6 x 10 cm T6 3 x 1,5 cm

20/120



96007 *stig*

Set 30 colori a cera in astuccio cilindrico | Coloured pencil set in cardboard case.30pcs. Small size | Juego de 30 pinturas de cera en tubo | Set 30 couleurs de cire avec boîte cylindrique
Cartone | Carton | Cartón | Carton

Ø 6 x 10,2 cm T6 | UV2 3 x 1,5 cm

20/120



96005 *mayra*

Set 12 colori a cera | Coloured wax pastel set in cardboard box.12pcs | Juego de 12 pinturas de cera en caja | Set avec 12 crayons de cire
Cartone | Carton | Cartón | Carton

10 x 0,9 x 9 cm S2 | UV9 5 x 5 cm

60/240

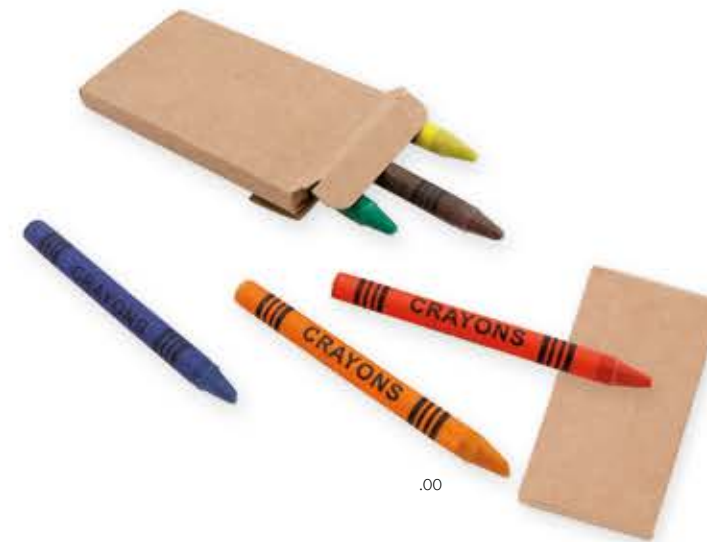

96003 *pegaso*

Set 6 colori a cera | Coloured wax pastel set in cardboard box. 6pcs | Juego de 6 pinturas de cera en caja | Set crayons couleurs de cire
Cartone | Carton | Cartón | Carton

5 x 0,9 x 9 cm T23 | UV2 3,5 x 5 cm 120/480



96037 *liki*

Block notes con pastelli a cera | Notepad with wax pastels | Bloque de notas con ceras | Bloc-notes avec pastels de cire
Carta | Paper | Papel | Papier

9 x 1 x 10,5 cm S2 4 x 1 cm 200

PASSEL set



96036 *bidi*

Set magneti e pastelli | Magnetic wooden figures set with pastels | Set imanes y ceras | Set aimants à colorier avec pastels dans leur boîte cadeau
Legno | Wooden | Madera | Bois

8 x 8 x 2 cm S95 3 x 1 cm 50/250



96150 *huron*

Tubo con 6 pastelli colorati | Coloured pastel set of 6 pieces | Juego de 6 pinturas de cera | Set crayons couleurs de cire
Cartone | Carton | Carton | Carton

Ø 2,7 x 10 cm T3 | UV2 5 x 1,5 cm 50 / 400



96020 *kimi*

Matita flessibile, creata con uno speciale materiale elastico | Flexible pencil, made of a special elastic material | Lápiz flexible, hecha con un material elástico especial | Crayon flexible

☞ 0,6 x 32 cm ☞ T27 5 x 0,5 cm ☞ 1000

96113 *lufy*

Set da disegno | Drawing set | Set de dibujo | Set dessin
PVC, legno | PVC, wood | PVC, madera | PVC, bois

☞ 15 x 1 x 10,5 cm ☞ S2 | UV9 4 x 2 cm ☞ 100/200



96072 *ivanhe*

Matita con animale | Pencil with animal | Lápiz con animal | Crayon avec animal
Legno | Wooden | Madera | Bois

☞ 21 cm ☞ T27 5 x 0,5 cm ☞ 50/400



DRAWING set



96141 *michiko*

Pastelli con fogli da colorare in custodia | Colouring set with crayon | Set de dibujo | Set dessin avec couleurs de cire
PVC | PVC | PVC | PVC

☞ 12 x 9 cm ☞ S93 3 x 3 cm ☞ 50/400



17159 *afonino*

Grembiule da colorare con 4 pastelli | Drawing apron | Drawing apron | Tablier à colorier avec 4 crayons pastel
Non woven | Non woven | Non woven | Non woven

☞ 50 x 50 cm ☞ S98 10 x 10 cm ☞ 200

64145 *locle*

Zainetto con pastelli | Drawstring bag with pastels | Mochila con ceras | Sac à dos avec crayons pastel
Non Woven

☞ 27 x 33 cm ☞ S98 15 x 15 cm ☞ 200



.08

.23

96849 *noelia*

Astuccio accessoriato, 14 pezzi | Pastels and pencil case, 14 pieces
| Estuche con lápices y ceras | Etui avec pastels et crayons, 14 pièces
Plastica | Plastic | Plástico | Plastique

9 x 13 x 2 cm S2 4 x 4 cm 24/144

MARKER set



.00

96354 *moncalieri*

Astuccio accessoriato, 67 pezzi | Pastels, markers and pencil case, 67 pieces
| Estuche con lápices, ceras y rotuladores | Etui avec pastels, marqueurs et crayons, 67 pièces

Cartone | Carton | Carton | Carton

18 x 16 x 10 cm S96 | UV19 5 x 5 cm

20

children
530



.08

.05

96077 *marenas*

Astuccio accessoriato, 67 pezzi | Pastels, markers and pencil case, 67 pieces
| Estuche con lápices, ceras y rotuladores | Etui avec pastels, marqueurs et crayons, 67 pièces

Plastica | Plastic | Plástico | Plastique

28 x 21 x 5 cm S95 6 x 6 cm 25



.00

96820 *sebe*

Set acquarelli e pastelli | Kit watercolours and pastels | Kit de acuarelas y ceras
| Set pastels et aquarelles

Legno | Wood | Madera | Bois

15,5 x 12 x 2,5 cm S96 | UV19 6 x 4 cm 12/48



.06

.08

96146 *giungano*

Set colori con 36 accessori | Colouring box | Set para colorear

Plastica | Plastic | Plástico | Plastique

18 x 18,5 x 3,5 cm S95 1/50

children
531



96068 kimisy

Penna a sfera | Ballpen | Bolígrafo | Stylo à bille. Commande pour min. 24pcs

Legno | Wooden | Madera | Bois

15 cm T27 4 x 0,7 cm 24/576



96098 devon

Penna a sfera 'Animaletti', prezzo cadauno, minimo ordine 24 pezzi assortiti in vari soggetti | Ballpen (assorted, price per piece, minimum quantity order 24 pcs) | Bolígrafo surtidos en forma de animal en caja de 24 unidades, precio por unidad | Stylo à bille "animal" prix pour chacun, commande minimum de 24 pièces, assortis de sujets variés

Legno | Wooden | Madera | Bois

15 cm T27 4 x 0,7 cm 24/576



29191 odessa

Temperamatite rotondo | Pencil sharpener | Sacapuntas | Taille crayon

Plastica | Plastic | Plastico | Plastique

Ø 3,5 T23 / UV1 Ø 3 cm 2880



PENCIL sharpener



29084 hansi

Temperino colorato | Sharpener | Secapuntas | Taille-crayons

Plastica | Plastic | Plastico | Plastique

6 x 4,5 x 1,5 cm T7 2 x 2 cm 24/574

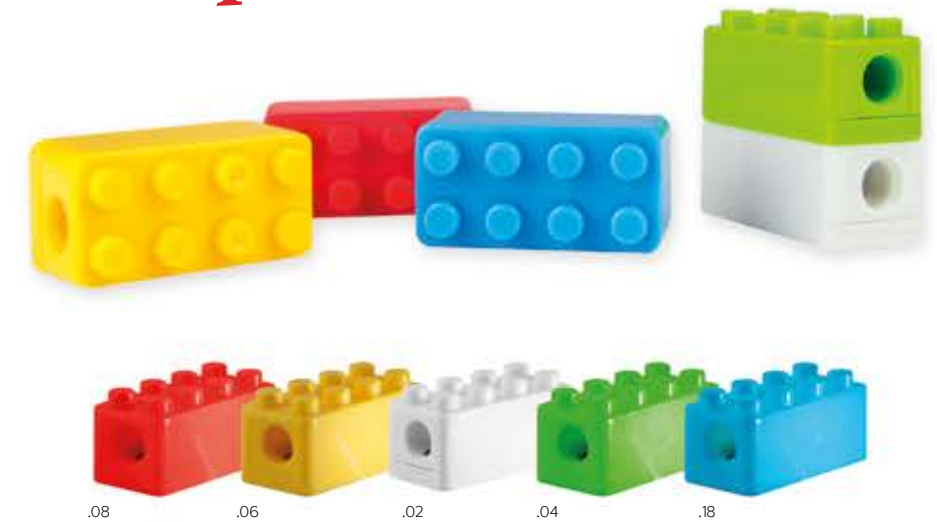

29252 grantola

Temperino a forma di costruzione. | Pencil sharpener | Sacapuntas | Taille crayon en forme de construction

Plastica | Plastic | Plástico | Plastique

4 x 2 x 2 cm T7 3 x 1 cm 50/2500

RUBBER



29000 *cicoria*

Gomma per cancellare | Eraser | Goma | Gomme
Gomma | Rubber | Caucho | Caoutchouc

6 x 4 x 1 cm UV2 3 x 2 cm 50/1000

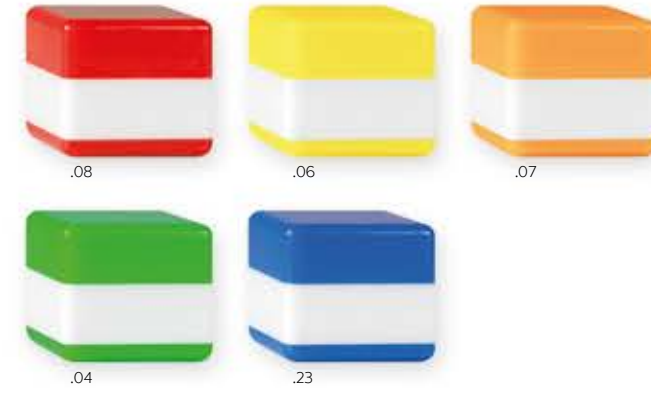

95032 *valje*

Timbro "Great" | "Great" seal | Sello "Great" | Tampon "GREAT"
Plastica | Plastic | Plástico | Plastique

2,8 x 2,8 x 3 cm S100 1,5 x 1,5 cm 1000



29205 *bordeaux*

Temperino con gomma | Pencil sharpener with rubber and container | Sacapuntas con goma y contenedor para virutas del lápiz | Taille-crayon avec gomme et dévidoir ABS

4 x 6 x 2,3 cm T7 2x 1 cm 36/864



29106 *sunuk*

Temperamatite con gomma | pencil-sharpener with eraser | Sacapuntas con goma | Taille-crayon avec gomme

6 x 3 x 2,1 cm T23 1 x 1 cm 20/600

29225 *cristallo*

Gomma per cancellare. | Rubber | Goma | Gomme
Plastica | Plastic | Plástico | Plastique

6,5 x 3,5 x 1,5 cm T23 | UV2 1,5 x 1 cm

50/300



95089 *variera*

Set di gomme a forma di frutta in scatola | Set of fruit shaped rubbers in a box | Set de gomas de borrar con forma de fruta en cajita | Set gomme en forme de fruits avec boîte

Plastica, gomma | Plastic, rubber | Plástico, goma | Plastique, cauchou

9 x 4,2 x 2,5 cm T6 5 x 2 cm 400



96160 *vänskaplig*

Gessetti in 4 colori | 4 colour chalks | Tizas de 4 colores | Craies en 4 couleurs

Gesso | Chalk | Tiza | Craies

9,5 x 2,5 x 11 cm S2 5 x 5 cm 100

95009 swane

Penna a sfera con laccetto e bolle di sapone | Ballpoint pen with necklace | Boligrafo a las burbujas de jabon | Stylo à bille fabrique bules de savon avec accroche-cou

Plastica, liquido non fornito | Plastic, liquid not included | Plástico, liquido no incluido | Plastique, liquide non inclus

16 cm T27 1 x 1 cm 50/500

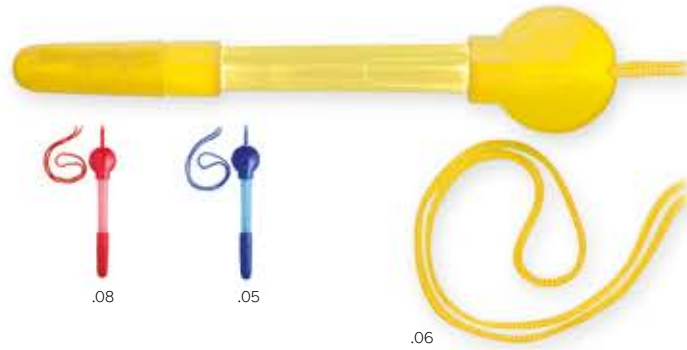

.08

.05

.06



.08

.04

.17

.05

.06

children
536

95068 pamir

Flaconcino bolle di sapone | Bubble maker | Juguete pompas jabón | Jouet de bulle de savon

Plastica, liquido non fornito | Plastic, liquid not included | Plástico, liquido no incluido | Plastique, liquide non inclus

11,2 x Ø 3,7 cm T6 4 x 1 cm | AD3 12 x 5 cm 50/500



BLOCK notes



children
537



.04

.07

.17

.18

40164 gonga

Block note con spirale | Notebook | Bloc de notas | Carnet avec figurine cheval

Carta | Paper | Papel | Papier

10,5 x 8 cm S64 5 x 2 cm 50/400



.23

.11

.04

40022 konz

Block-notes, soggetto animale | Animal shaped block-notes | Block-notes colorado | Bloc-notes avec petits animaux en décoration

Cartone, carta | Cardboard, papers | Carton, papier | Carton, papier

10,5 x 8 x 1 cm S64 UV2 5 x 2 cm 50/200

PENCIL case



99004 heimo

Astuccio portamatite | Pencil case | Estuche de lápices | Trousse
Poliestere 600D | Polyester 600D | Polyestér 600D | Polyester 600D

22 x 11 cm S8 | TR1 7 x 2 cm 10/500

99030 kingstown

Portamatite | Pencil case | Estuche para lápices | Trousse à crayons
Non Woven 80 g/m²

21 x 11 cm S8 | TR1 6 x 2 cm 1000



.13

99027 singapore

Astuccio | Pencil case | Estuche | Trousse
Cotone | Cotton | Algodon | Coton

7 x 22 cm S8 | TR27 6 x 2 cm 20/460



.08

99002 grisù

Astuccio portamatite | Pencil case | Estuche de lapices | Etui porte
crayons
PVC

22 x 10 cm S8 10 x 3 cm 25/500



.05



.06



.08



.02

96051 umma

Set Righello (15 cm) con 2 matite, gomma e temperamatite | Ruler set (15
cm) with two wooden pencils, plastic sharpener and eraser, 5 pcs | Regla
de 15 cm con 2 lápices, sacapuntas y goma de borrar | Set avec règle
(15cm), 2 crayons, une gomme et un taille-crayons
Plastica | Plastic | Plástico | Plastique

20,7 x 3 x 4 cm T8 2 x 1 cm 50/200

96897 neron

Astuccio con all'interno matita, penna, righello, gomma e temperino
| School set with pencils, pen, ruler 15 cm, rubber and sharpener
| Set escuela compuesto de lápiz, bolígrafo, regla, goma de borrar y
sacapuntas | Trousse avec crayon, stylo, règle, gomme et taille-crayon
Non-Woven | PVC

22 x 11,8 cm S93 5 x 2 cm 50/200



.29



.07

.18

99017 *tabea*

Astuccio | Pencil case | Estuche | Trousse
Poliestere 600D | Polyester 600D | Polyestér 600D | Polyester 600D
12x21 x 8,5 x 6,5 cm 88 S8 | TR1 7 x 2 cm 100/400



.04



.06

.07

.05

.08

.17

99040 *polessk*

Astuccio portamatite | Pencil case | Estuche de lápices | Trousse
PVC
12x24,5 x 11,5 cm 88 S8 6 x 2 cm 10/500



.05



.04

.08

.01

.06

.07

.17

99028 *agra*

Astuccio | Pencil case | Estuche | Trousse
Poliestere 600D
12x22,5 x Ø 6,5 cm 88 S8 | TR1 6 x 2 cm 100



.08



.06

.05

.01

43141 *galeta*

Pochette con cerniera | Clutch bag | Neceser | Trousse de toilette
Poliestere 600D
12x20 x 4,5 x 6 cm 88 S8 10 x 4 cm 1/400



.17

.05

.08

.07

43002 *elias*

Spazzolino da denti, bimbi | Kids toothbrush | Cepillo de dientes, niños | Brosse à dent, enfants
Plastica | Plastic | Plástico | Plastique
12x3 x 14,6 x 1 cm 88 T6 1 x 1,5 cm 50/500



.19

43026 *cruz*

Portaspazzolini con clessidra 3" | Tooth brush with 3" hourglass | Porta cepillo de dientes con reloj de arena 3" | Porte brosse à dent avec sablier 3"
Plastica | Plastic | Plástico | Plastique
12x14 x 8,5 x 6,5 cm 88 T8 2 x 2 cm 1/100



.08

.04

.06

.05

43133 *greccio*

Spazzolino con clessidra in astuccio trasparente. | Cleaning tooth set. | Set cepillo dientes | Brosse à dent avec sablier dans pochette transparente
Plastica | Plastic | Plástico | Plastique
12x8 x 20 x 2 cm 88 S8 3 x 3 cm 50/200

29255 skurar

Portamatite con portamemo frontale in diversi soggetti assortiti | Pen holder with clip on the front. Different models mixed | Porta lápices con clip en la parte frontal. Varios modelos | Porte crayons avec porte-mémos frontale. Sujets divers
Legno | Wood | Madera | Bois

8,5 x 7 x 5,3 cm



ribba

children
542



.18

.07

.08

96142 cedro

Righello | Ruler | Regla | Règle
Plastica | Plastic | Plástico | Plastique

19 x 4,5 cm T23 2 x 1 cm 100/2000



.19

.08

.02

.05

.06

26372 fidget spinner

Fidget spinner | Fidget spinner | Fidget spinner | Fidget spinner
ABS, metallo | ABS, metal | ABS, metal | ABS, métal

7,5 x 7,5 x 1,2 cm T33 | UV20 Ø 1,3 cm 50 / 200

SET CHILD OF KITCHEN apron



.19



.02



.17



.23

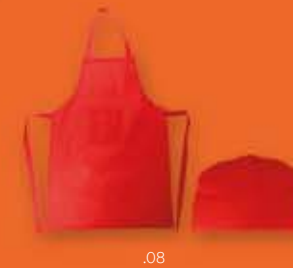

.08

17480 avignon

Set bambino grembiule e cappello da cucina | Set child of Kitchen apron and hat | Juego niños de delantal y gorro de cocina | Set enfant tablier et chapeau de cuisine
TNT Non Woven 80gr/m²

60 x 40 cm / hat size 56 S25 5 x 5 cm / 10 x 10 cm 1/200



17166 *montevideo*

Grembiule da cucina per bambini | Children apron | Delantal de cocina para niños 80g | Tablier de cuisine pour enfants 80g
Non woven 80 gr

40 x 60 cm S98 10 x 10 cm 350



29240 *twig*

Portafoto in legno | Wooden photo frame | Marco de fotos en madera | Porte photo en bois
Legno | Wood | Madera | Bois

8 x 18 x 4,4 cm T8 | S27 2,5 x 1 cm 50/100



95881 *walti*

Bracciale che si posiziona al tocco | Snap armband | Banda flexible | Bracelet flexible
PVC

2,9 x 23 cm T6 10 x 0,8 cm 50/1000



64190 *gintama*

Zaino con tasca frontale | Backpack for kids. | Mochila para niños | Sac multicolor avec poche frontale zippée.
Poliéster 600D | Polyester 600D | Poliéster 600D | Polyester 600D

29 x 9,5 x 30 cm S78 5 x 6 cm 1/50



64084 *inga*

Zaino | Drawstring bag | Mochila | Sac à dos avec coulisse
Non woven

30 x 35 cm S76 | TR7 15 x 15 cm 25/300



64103 *chennai*

Zaino con tasca frontale | Backpack | Mochila | Sac à dos
Poliestere 600D | Polyester 600D | Poliéster 600D | Polyester 600D

22 x 26,5 x 8 cm S78 7 x 7 cm 100



64107 *roseau*

Zaino pieghevole | Foldable backpack | Mochila plegable | Sac à dos pliable
Non woven

28,5 x 33,5 cm S31 8 x 8 cm 500



64195 garbagnate

Zaino | Drawstring bag. | Mochila | Sac à dos Polyester 210D | Polyester 210D | Poliéster 210D | Polyester 210D

30 x 40 cm S76 18 x 8 cm 20/200

children
546



64016 kay

Zaino | Drawstring bag | Mochila | Sac Poliestere 190T | Poliestere 190T | Poliestere 190T | Polyester 190T

26 x 32 cm S98 15 x 15 cm 20/500

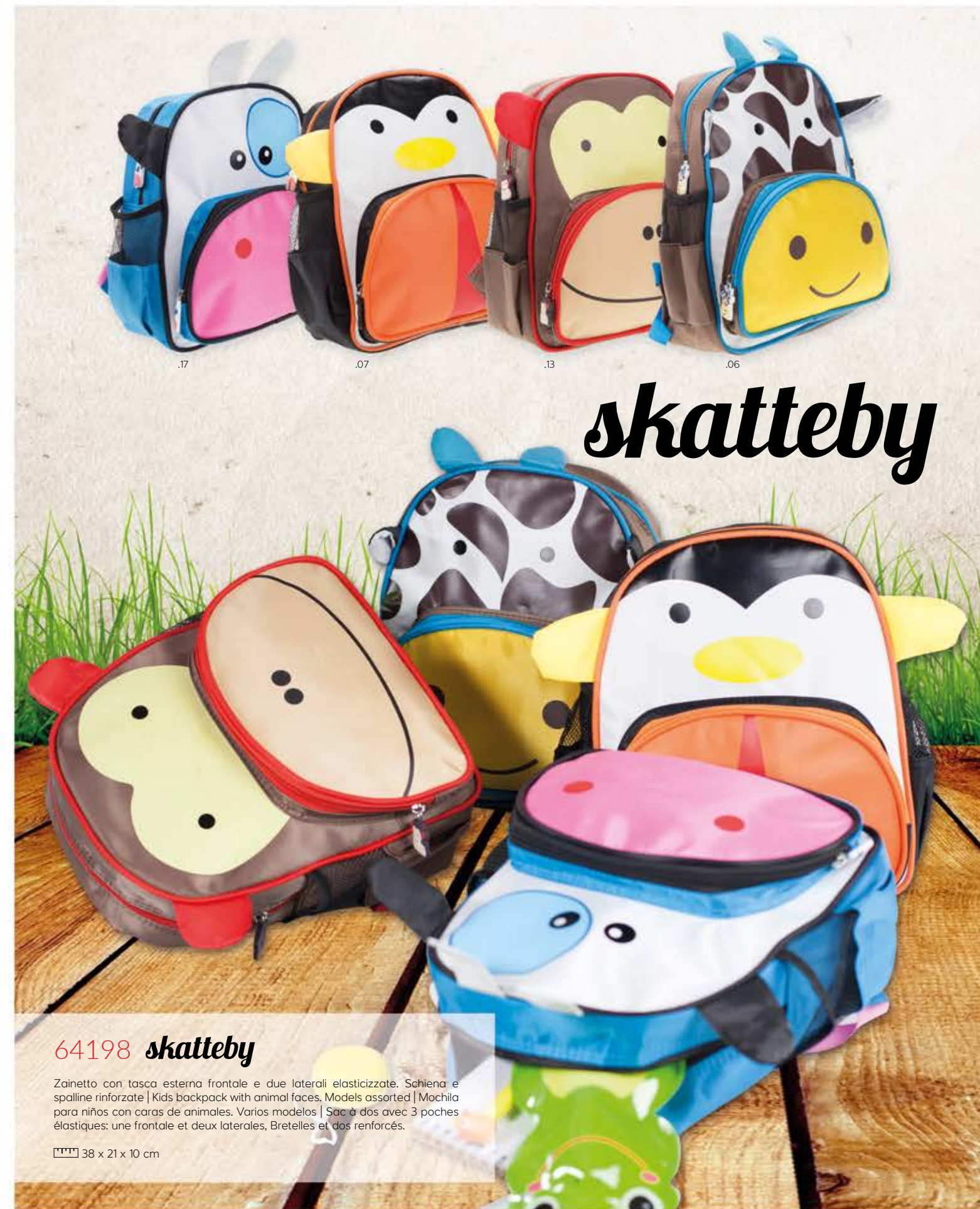

skatteby

64198 skatteby

Zainetto con tasca esterna frontale e due laterali elasticizzate. Schiena e spalline rinforzate | Kids backpack with animal faces. Models assorted | Mochila para niños con caras de animales. Varios modelos | Sac à dos avec 3 poches élastiques: une frontale et deux laterales, Bretelles et dos renforcés.

38 x 21 x 10 cm



95252 *tiba*

Peluche Teddy Bear (maglia esclusa - art. 95250) | Teddy bear plush (for t-shirt see item 95250) | Orso de peluche (sin camiseta art 95250) | Nounours. Tshirt exclu (article 95250)

Peluche | Plush | Peluche | Peluche

20 cm 12/36



95251 *kea*

Orso bianco di peluche (t-shirt art. 95250 esclusa) | White teddy bear (white t-shirt item 95250 excluded) | Oso blanco de peluche sin camiseta | Nounours. Tshirt exclu

Peluche | Plush | Peluche | Peluche

20 cm 12/36



95257 *rike*

T-shirt per peluche - pelo lungo | T-shirt for plush | Camiseta para peluches | T-shirt pour peluche

Poliestere | Polyester | Poliéster | Polyester



95250 *tida*

T-shirt per peluche | T-shirt for plush | Camiseta para peluches | T-shirt pour peluche

S39 | TR17 4 x 2 cm 12/180



95269 *iner*

Peluche Orso (maglia esclusa - art. 95250) | Bear Plush (for t-shirt see item 95250) | Osito de peluche (sin camiseta art 95250) | Nounours. Tshirt exclu (article 95250)

Peluche | Plush | Peluche | Peluche

20 cm 12/36



95256 *zippora*

Peluche orso (maglia inclusa) | Bear plush with t-shirt | Oso con camiseta | Ours en peluche avec t-shirt

Poliestere | Polyester | Poliéster | Polyester

12 cm S11 3 x 3 cm 50



95291 *nicki*

Peluche Topo (maglia esclusa - art. 95250) | Mouse plush (for t-shirt see item 95250) | Ratón de peluche (sin camiseta art 95250) | Peluche souris. Tshirt exclu (article 95250)

Peluche | Plush | Peluche | Peluche

20 cm 12/36



95244 *klivi*

Peluche orso (maglia inclusa) | "Teddy bear"Plush" (t-shirt included) | Peluche orso (camiseta incluida) | Nounours. Tshirt inclu

Peluche | Plush | Peluche | Peluche

20 cm S39 | TR17 3 x 3 cm 1/50



95283 *murom*

Portachiavi con peluche e maglietta | Plush toy keyring with t-shirt | Llavoro con peluche y camiseta | Porte-clés peluche avec t-shirt

Poliestere | Polyester | Poliéster | Polyester
 6,5 x 7,5 x 4 cm S11 2 x 2 cm 50/500

95077 *guija*

Portachiavi con peluche | Plush keyring | Llavoro con peluche | Porte-clés peluche

Plush | Plush | Plush | Plush
 8 cm S11 2 x 1,5 cm 20 / 200

95091 *itat*

Portachiavi con peluche e t-shirt in poliester inclusa | Plush keyring with polyester t-shirt included | Llavoro con peluche y camiseta in poliéster incluida | Portecclés peluche, avec t-shirt en polyesterie incluse

Peluche | Plush | Peluche | Peluche
 15 cm S11 2 x 2 cm 50/300



95076 *bassa*

Peluche orso con t-shirt | Plush bear with t-shirt | Oso con camiseta blanca | Ours avec t-shirt blanc

Peluche | Plush | Poliéster | Plush
 15 cm S11 3 x 3 cm 100

PLUSH BEAR
 with t-shirt



95075 *värde*

Peluche | Plush | Peluche | Peluche
 Poliestere | Polyester | Poliéster | Polyester

h 22,5 cm S11 6 x 6 cm 60



95071 *kurma*

Peluche renna | Reindeer plush | Reindeer plush | Peluche renne

Poliestere | Polyester | Poliéster | Polyester
 12 cm S11 4 x 2 cm 150

95209 *hiob*

Peluche renna (maglia esclusa - art. 95250) | Plush "reindeer" (for t-shirt see item 95250) | Peluche ciervo (sin camiseta) | Peluche renne (t-shirt exclude)

Peluche | Plush | Peluche | Peluche

20 cm 12/36

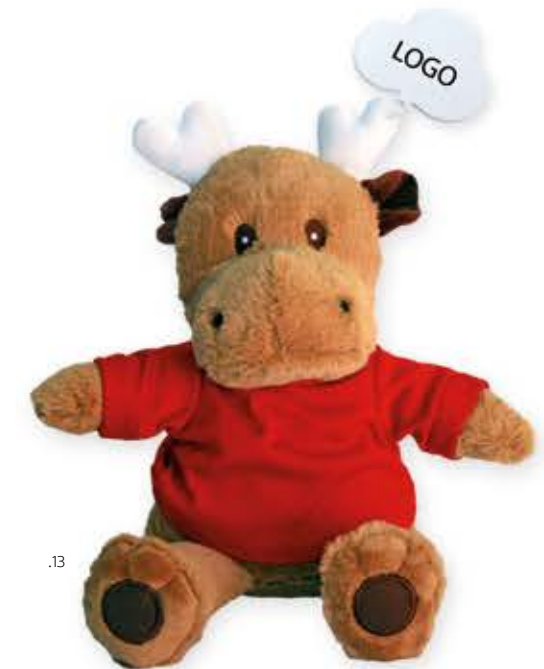



.08



.06



.05

photo frame



49120 **itzik**

Portafoto in legno | Wooden photo frame | Marco de fotos en madera | Porte photo en bois
Legno | Wood | Madera | Bois

15,5 x 10,5 cm 🌳 T7 4 x 1 cm 📦 25/300



.04



.05



.07

49107 **kord**

Portafoto in legno (foto 5,5 x 5,5 cm) | Wooden photo frame (photo 5,5 x 5,5 cm) | Marco de foto en madera, tamaño máximo de la foto: 5,5 x 5,5 cm | Porte photo en bois (5,5 x 5,5 cm)
Legno | Wooden | Madera | Bois

15,5 x 10,5 cm 🌳 T7 4 x 1 cm 📦 48/288



.04

.06

29016 **catambra**

Pinza porta memo | Memo holder | Pinza portanotas | Porte memo
Legno | Wood | Madera | Bois

13 x 3,3 cm 🌳 T7 2 x 1 cm 📦 30/240



74005 *madina*

Tazza Mug, con trattamento per sublimazione, capacità 300 ml con box | Mug for sublimation printing in individual box, 300 ml | Taza para sublimation 300 ml | Tasse pour personnalisation en sublimation avec boîte individuelle (300ml)

Ceramica | Ceramic | Cerámica | Céramique

☞ ☞ ☞ Ø 8 x 9 cm ☞ ☞ SP2 8 x 20 cm ☞ 1/36



74134 *kosulino*

Tazza con gessetto, 300 ml | Mug with chalk | Mug with chalk | Tasse avec ardoise 300 ml

Ceramica | Ceramic | Cerámica | Céramique

☞ ☞ ☞ Ø 9 x 10,5 cm ☞ ☞ T28 3 x 1,5 cm ☞ 36



74055 *maike*

Tazza soggetto animale | Animal shaped mug | Taza en forma de animal | Tasse sujet animal

Ceramica | Ceramic | Cerámica | Céramique

☞ ☞ ☞ Ø 8,3 x 9,7 cm ☞ ☞ T28 3 x 3 cm ☞ 1/36



74052 *malin*

Tazza soggetto animale | Animal shaped mug | Taza en forma de animal | Tasse sujet animal

Ceramica | Ceramic | Cerámica | Céramique

☞ ☞ ☞ Ø 8,32 x 9,4 cm ☞ ☞ T28 2 x 1 cm ☞ 1/36



74110 *nilo*

Tazza con lavagna | Mug with blackboard | Taza con pizarra | Tasse avec tableau noir

Ceramica | Ceramic | Cerámica | Céramique

☞ ☞ ☞ Ø 8,5 x 10 cm ☞ ☞ T28 2 x 2 cm ☞ 1/40



74031 *zuli*

Tazza con gessetto | Mug with chalk | Copa con tiza | Tasse avec craie

Ceramica | Ceramic | Cerámica | Céramique

☞ ☞ ☞ Ø 8 x 9 cm ☞ ☞ T28 | C3 4 x 4 cm ☞ 1/36



99037 *cannella*

Salvadanaio | Coin bank with bottom lid | Hucha | Tirelire
Plastica | Plastic | Plástico | Plastique

7,1 x 7,3 x 9,3 cm T7 3 x 3 cm 1/36



99100 *gimbito*

Salvadanaio | Money box | Hucha | Tirelire
Metallo | Metal | Metal | Métal

10,5 x 7,5 x 7,5 cm T8 | L13 5 x 3 cm 1/50



99014 *koro*

Salvadanaio 'Porcellino', con tappo | Piggy shaped coin bank | Hucha en forma de cerdito con tapón | Tirelire en forme de cochon avec fermeture

Ceramica | Ceramic | Cerámica | Céramique

10 x 8 x 6,5 cm T8 | S2 4 x 1 cm 1/50

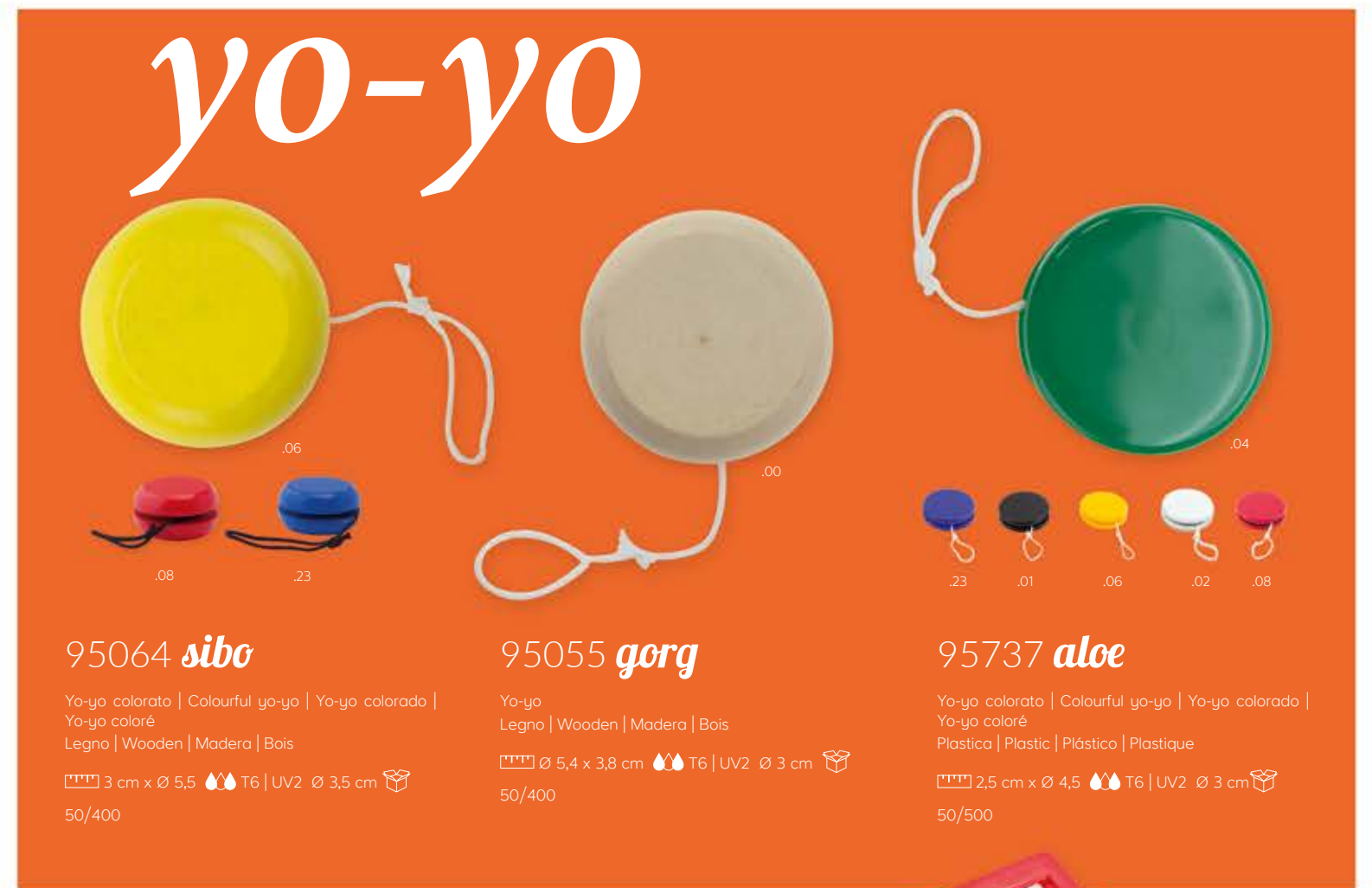

95064 *sibo*

Yo-yo colorato | Colourful yo-yo | Yo-yo colorado | Yo-yo coloré
Legno | Wooden | Madera | Bois

3 cm x Ø 5,5 T6 | UV2 Ø 3,5 cm 50/400

95055 *gorg*

Yo-yo
Legno | Wooden | Madera | Bois

Ø 5,4 x 3,8 cm T6 | UV2 Ø 3 cm 50/400

95737 *aloe*

Yo-yo colorato | Colourful yo-yo | Yo-yo colorado | Yo-yo coloré
Plastica | Plastic | Plástico | Plastique

2,5 cm x Ø 4,5 T6 | UV2 Ø 3 cm 50/500



43028 *halle*

Giocattolo camion | Freight truck toy | Trailer de juguete | Camion jouet

Plastica | Plastic | Plástico | Plastique

18 x 3 x 4,5 cm S3 | UV17 10 x 2 cm 50/100



95067 *kunlun*

Gioco | Game | Juego | Jeu
Plastica | Plastic | Plástico | Plastique

4,2 x 1,2 x 4,6 cm T6 2 x 2 cm 100/1000



DRINKING *bottle*

children
558



96057 *reimo*

Lavagna con pennarello | Whiteboard with pen | Pizarra con rotulador y borrador | Ardoise avec feutre
Plastica | Plastic | Plástico | Plastique

19,8 x 17 x 1,4 cm T7 5 x 2 cm 50/200



96066 *bellistafis*

Padella da neve | Sitting sled | Trineo sentado | Luge pelle à neige
Plastica | Plastic | Plástico | Plastique

38,5 x 57,5 x 3,5 cm T10 15 x 15 cm 10/50



52047 *doha*

Borraccia bambino | Drinking Bottle | Bidón plegable | Gourde enfants
Plastica | Plastic | Plástico | Plastique

24 x 14 cm S91 3 x 3 cm 50/300

doha



.07



.02

.05

.04

.06

.08

.01

95025 mitzi

Fischietto da collo (min. 48pz) | Whistle with necklace (min. 48 pcs) | Silbato colgante (min. 48 uds) | Sifilet avec accroche-cou
Plastica | Plastic | Plástico | Plastique

5 x 2 x 2,5 cm T23 Ø 1,2 cm 48/1440



.02

95015 riek

Gioco del quindici | Fifteen puzzle | Quince rompecabezas | Puzzle des quinze
Plastica | Plastic | Plastico | Plastique

7 x 9 cm T6 (5 x 1,5) | UV9 (7 x 9 cm) 50/500



.09

95024 gord

Gioco di pazienza 4 x 4 x 4 cm, prezzo cad, min. ordine 24 pezzi assortiti in vari soggetti | Display box with 24 mind games 4 x 4 x 4 cm, price per piece, min order quantity 24pcs assorted | Jeu de patience 4 x 4 x 4, prix unitaire, commande min. de 24pcs, objets divers
Plastica | Plastic | Plástico | Plastique

25,5 x 17 x 4,1 cm T23 3 x 3 cm 24 / 576



.02

29199 lugano

Puzzle 40 pezzi
Cartone | Carton | Carton | Carton

Ø 20 cm SP19 Ø 20 cm 50/500



.00

95539 pato

Mini-calcetto con 2 palline | Mini table soccer with two balls | Mini mesa futbol con 2 pelotas | Mini baby-foot avec 2 balles
Legno | Wooden | Madera | Bois

35 x 23 x 7 cm AD4 3 x 3 cm 1/6

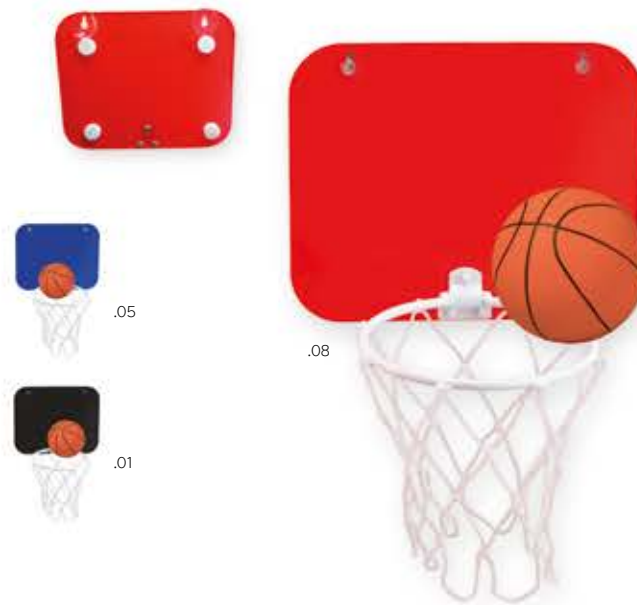

.05

.08

.01

95057 kustavi

Canestro | Basket | Cesto de baloncesto | Panier de basket
PVC

20 x 16 cm T8 5 x 3 cm 100



.02

.23

.08

95026 silo

Mano che applaude | Hand clapper | Mano felicidad | Main qui applaudit
Plastica | Plastic | Plástico | Plastique

8 x 18 x 2 cm T6 3 x 1,5 cm 100/200



.02

95014 hese

Maracas
Plastica | Plastic | Plástico | Plastique

7 x 19 x 7 cm T6 5 x 3 cm 10/100



95741 *brusali*

Puzzle da 9 pezzi | 9 pieces puzzle | Puzzle de 9 piezas |
Puzzle de 9pcs
Legno | Wood | Madera | Bois

15 x 15 x 0,5 cm ♻️ S3

.00

brusali



.00

95111 *siard*

Set gioco, 4-in-1, in scatola | 4 in 1 game set in box | Set de
4 juegos con ajedrez, damas, dominó, mikado y parchis
presentado en caja | Set jeux 4 en 1 dans son coffret
Legno | Wooden | Madera | Bois

19 x 13,8 x 3,1 cm ♻️ S2 | UV8 5 x 1,7 cm 📦 12/48



.00

95020 *breindel*

Set gioco in legno, 3 pezzi | Wooden game set, 3 pieces | Estuche de
juego en madera, 3 piezas | Jeu en bois, 3 pièces
Legno | Wood | Madera | Bois

7,8 x 24 cm ♻️ S2 | UV8 6 x 4 cm 📦 12/144



.00

95046 *trina*

Gioco Domino con scatola | Domino game in box | Juego dominó en
estuche | Jeu domino dans coffret
Legno | Wooden | Madera | Bois

16,5 x 3,5 x 5 cm ♻️ S2 | UV9 8 x 2 cm 📦 1/144

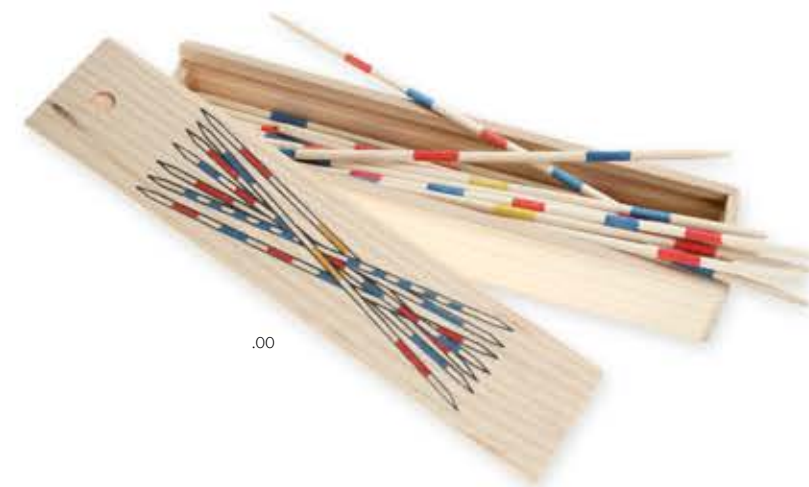

.00

95048 *udele*

Gioco Mikado in scatola | Mikado game in box | Juego mikado en
estuche | Jeu Mikado dans coffret
Legno | Wooden | Madera | Bois

19 x 2,5 x 4 cm ♻️ S2 | UV9 8 x 1,5 cm 📦 1/144

LEISURE

doomed to EXPERIENCE

Coperte, plaid, thermos in metallo e tazze. Sacchi a pelo, tende, accessori per il barbecue e utensili per le escursioni.

564 - 587

tempo libero - leisure - tiempo libre - loisir



.04

.05



.05



.08



.32



.01



.08



.04



.32

52505 *cook*

Bicchieri da viaggio 310 ml | Travel cup 310 ml | Vaso de viaje 310 ml | Verre de voyage 310ml

Stainless Steel | Stainless Steel | Acero inoxidable | Acier inoxidable

☞ 7,2 x 16,7 cm ☞ T8 | L10 ☞ 3 x 3 cm

52506 *droppar*

Bottiglia metallica 550 ml | Metallic bottle 550 ml | Botella metálica 550 ml | Bouteille métallique 550ml

Stainless Steel | Stainless Steel | Acero inoxidable | Acier inoxidable

☞ 7 x 26 cm ☞ L10 ☞ 3 x 3 cm



FLEECE & POLYESTER blanket



14015 *vindalsö*

Coperta di cotone | Cotton blanket | Manta de algodón | Couverture en coton
Cotone 420g | Cotton 420g | Algodón 420gr | Coton 420gr

125 x 150 cm 15

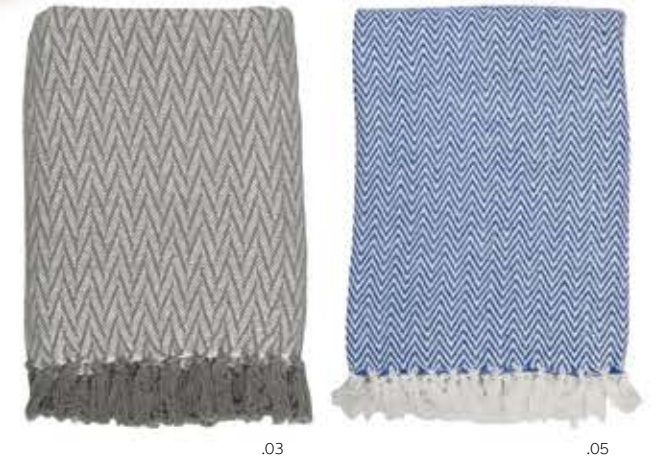

.00



.13 .02 .05 .08

14138 *omaha*

Plaid | Blanket | Manta | Couverture
Poliestere 250 gr/m² + 170 gr/m² | Polyesrer 250 gr/m² + 170 gr/m² |
Poliéster 250 gr/m² + 170 gr/m² | Polyester 250 gr/m² + 170 gr/m²

120x160 cm 1/12

14124 *buuren*

Coperta | Blanket | Manta | Couverture
Pile | Fleece | Tejido polar | Laine polar

130 x 160 cm 20



.23



.02 .01 .08

14016 *hemnes*

Trapunta di pile | Blanket | Manta polar | Couverture polaire
Microfibra 240 gr/m² | Microfiber 240grsm | Microfibra 240 gr/m² | Microfibre 240gr/m²

1160 x 130 cm S9 10 x 10 20



.02

14501 *lowell*

Plaid | Blanket | Manta | Couverture
Poliestere 280 gr/m² | Polyester 280 gr/m² | Poliéster 280 gr/m² |
Polyester 280 gr/m²

120 x 160 cm 15

14541 burk

Coperta in pile, con maniglia in nylon | Fleece blanket with nylon strap | Manta de viaje en tejido polar y asa de nylon | Couverture en laine polaire avec poignée en nylon
Pile | Fleece | Tejido Polar | Laine Polaire

160 x 125 cm S9 | TR12 10 x 4 cm 1/20



.18



.07



.08

leisure
568



.18



.05

.11

.02

.08

14500 allentown

Plaid | Blanket | Manta | Couverture
Poliestere | Polyesrer | Poliéster | Polyester

90 x 150 cm TR12 10 x 5 cm 1/20



.19



.05

.08

.13

14120 mark

Coperta | Blanket | Manta | Couverture
Pile | Fleece | Tejido polar | Laine polaire

145 x 95 cm 1/20



.07



.08

.01

.05

.04

.03

14589 baccarat

Coperta in pile Anti-Pilling | Anti-Pilling Polar Fleece blanket | Manta polar Anti-Pilling | Couverture Polaire Anti-Pilling
Pile 180g/m² | Fleece 180g/m² | Tejido polar 180g/m² | Laine Polaire 180g/m²

120 x 150 cm 20



.01



.07

.05

.13

.04

.08

14759 taman

Coperta in pile | Fleece blanket | Manta de viaje | Couverture
Pile Antipilling 200gr/m² | Fleece | Tejido Polar | Laine Polaire

160 x 130 cm S9 | TR12 10 x 4 cm 1/25

leisure
569

STAINLESS STEEL mug



.01



.04



.05



.08

52019 *keith*

Tazza con manico a moschettone. Capacità 200 ml. | Mug with carabiner handle | Taza con mango mosquetón | Tasse avec poignée mousqueton. Capacité 200 ml.

Acciaio inox | Stainless Steel | Acero inoxidable | Acier inox

📏 7 x 8,2 cm 💧 L13 | T8 5 x 2 cm 📦 50



.04



.32



.03

.05

52057 *vässad*

Tazza termica con coperchio | Thermic mug with top | Taza térmica con tapa | Mug thermique avec couvercle
Plastica, acciaio inox | Plastic, stainless steel | Plástico/Acero inoxidable | Plastique, acier inox

📏 Ø 8,6 x 10,7 cm 💧 T8 5 x 3 cm 📦 50



.17

.08

.05

.01

.32

74128 *guadalquivir*

Tazza, 300 ml | Mug, 300 ml | Taza, 300 ml | Tasse, 300 ml
Acciaio inox | Stainless Steel | Acero inoxidable | Acier inox

📏 8,9 x Ø 7,6 cm 💧 L13 | T8 5 x 2 cm 📦 50

52099 *betti*

Bicchieri estendibile | Foldable cup | Vaso ampliable | Verre allongeable
Acciaio inox | Steel inox | Acero inox | Acier inox

📏 Ø 5 x 6 cm 💧 L2 Ø 4,5 cm 📦 200





52073 *lis*

Bottiglia isoteramica colorata, 500 ml | Drinking bottle, 500 ml | Botella isotérmica, 500 ml | Thermos, 500ml
Plastica | Plastic | Plástico | Plastique

☞ Ø 7 x 24,5 cm ☞ T9 | L10 4 x 1 cm 📦 1/24



52012 *cirimoia*

Set termos con due bicchieri | Thermos Flask with two glasses | Set de termos con dos vasos en aluminio | Set termos avec deux verres
Acciaio | Stainless steel | Acero | Acier

☞ Thermos: Ø 7 x 24 | Mug: Ø 7 x 8 cm ☞ S9 | L12 10 x 5 cm 📦 10



52022 *keno*

Set termos (0,50 litri) e 2 tazze, confezione regalo | Travel set, with vacuum flask (0,5 litre) and two mugs (0,30 litre) in box | Caja de regalo con termo de 500 ml y 2 tazas de 300 ml | Set termos (500ml) avec 2 tasses (200ml) dans leur boîte cadeau

Acciaio | Steel | Acero | Acier

☞ 30,3 x 23,2 x 8,4 cm ☞ S86 | L12 4 x 2 cm 📦 1/10



52075 *carmen*

Thermos (350 ml) | Vacuum flask (350 ml) | Termo (350 ml) | Thermos (350 ml)
Acciaio inox | Stainless steel | Acero inoxidable | Acier inoxydable

☞ Ø 8,1 x 18 cm ☞ T9 | L10 4 x 1 cm 📦 1/30

THERMOS STEEL



52473 *marta*

Thermos (0,50 litri) | Vacuum flask, 0,5 litre | Termo de 500 ml acabado | Thermos 0,5 l
Acciaio | Steel | Acero | Acier

☞ Ø 6,1 x 26,3 cm ☞ T9 | L10 4 x 1 cm 📦 1/20

.32





52034 *belaya*

Tazza 450 ml | Mug 450 ml | Taza 450 ml | Tasse 450 ml
Plastica PP | Plastic PP | Plástico PP | Plastique PP

12 x Ø 8,5 cm T20 5 x 2 cm 25

leisure
574



.32

52092 *lovis*

Portachiavi a fiaschetta 30 ml | Key-chain with flask 30 ml | Llavero con petaca 30 ml | Portecleé avec flasque 30ml
Acciaio inox | Steel inox | Acero inox | Acier inox

5,8 x 4,2 x 1,2 cm L7 | T8 3 x 3 cm 1/100



.32

52083 *let*

Fiaschetta 200 ml | Thermo-flask 200 ml | Petaca 200ml | Flasque 200ml

Acciaio inox | Steel inox | Acero inox | Acier inox

12,5 x 9 x 2 cm L7 | T8 4 x 4 cm 1/100



52021 *gilbert*

Tazza thermos 400 ml | Thermal mug 400 ml | Taza térmica 400 ml | Mug thermique 400 ml
Plastica | Plastic | Plástico | Plastique

Ø 8 x 17 cm T8 5 x 2 cm 48

52502 *cicerbita*

Bicchiere termico 400 ml | Thermal cup 400 ml | Taza térmica 400 ml | Mug thermique 400 ml
Alluminio | Aluminium | Aluminio | Aluminium

Ø 8 x 16,5 cm T8 | L10 4 x 2 cm 1/50



.04

.05

.07

.01

74126 *fox*

Bicchiere con fessura sul coperchio, 400 ml | Mug with drinking opening, 400 ml | Vaso con apertura para beber en tapa, 400 ml | Verre avec fente sur couvercle, 400 ml

Acciaio inox | Stainless Steel | Acero inoxidable | Acier Inox

18,2 x Ø 7,6 cm T8 | L10 5 x 2 cm 50

leisure
575



.32

52086 *lolo*

Tazza termica con apertura drink sul coperchio, 450 ml | Thermo mug with drinking opening, 450 ml | Termo-taza con apertura en la tapa, 450 ml | Tasse thermique avec ouverture drink sur le couvercle 450ml

Acciaio, plastica | Stainless steel, plastic | Acero inoxidable, Plástico | Acier, plastique

12,5 x 8 x 17, 3 cm T8 | L10 3,5 x 3,5 cm 1/24



52503 *dragon*

Bottiglia 450 ml con custodia termica | Bottle 450 ml with thermal case | Botella 450 ml con funda térmica | Bouteille de 450ml avec étui thermique
Vetro | Glass | Vidrio | Verre

☞ Ø 6,4 x 19 cm 🚰 S93



52061 *duktig*

Borraccia 550 ml con tappo colorato | Bottle 550 ml with coloured cap | Botella de 550 ml con tapón de color | Gourde de 550ml avec bouchon coloré
Plastica | Plastic | Plástico | Plastique

☞ Ø 6,5 x 19,5 cm 🚰 T20



52058 *immeln*

Tazza 500ml con dettagli colorati | Mug 500ml with coloured details | Taza 500ml con detalles de color | Mug 500ml avec détails colorés
Acciaio inox | Stainless steel | Acero inoxidable | Acier inox

☞ 18 x Ø 8,60 cm 🚰 T8 | L10 📦 50



74143 *guamaggiore*

Bicchiere da viaggio (Capacità 450 ml.) | Travel cup with a lid | Vaso de viaje, 450 ml | Mug de voyage
Acciaio, PP | steel, PP | Acero, PP | Acier, PP

☞ Ø 8,1 x 16,7 cm 🚰 T8 | L10 5 x 2 cm 📦 1/50



76051 *wintersaga*

Bottiglia trasparente da 1 litro con tappo colorato | 1 liter transparent bottle with coloured cap | Botella transparente de 1 litro con tapón de color | Bouteille transparente avec bouchon coloré.
Capacità 1LT

Tritan | Tritan | Tritan | Tritan

☞ Ø 8 x 23 cm 🚰 T20 4 x 6 cm 📦 50



76029 *milford*

Borraccia 650 ml | Jug 650 ml | Botella para agua 650 ml | Bouteille à eau 650 ml
Plastica | Plastic | Plástico | Plastique

☞ 25 x Ø 6,5 cm 🚰 T20 | S92 5 x 2 cm 📦 10/60



52033 *baena*

Bicchiere termico, 330 ml | Thermal mug with drinking opening, 330 ml | Taza térmica con apertura para beber en tapa, 330 ml | Verre thermos, 330 ml

Acciaio inox | Stainless Steel | Acero inoxidable | Acier Inox

☞ 16,5 x Ø 7 cm 🚰 T8 | L10 5 x 2 cm 📦 25



.21

52088 *walo*

Tazza pubblicizzabile con stampa digitale, apertura drink sul coperchio, 450 ml | Mug for digital printing with drinking opening on the lid, 450 ml | Taza para personalización digital con apertura en la tapa, 450 ml | Tasse pour personnalisation digitale avec ouverture drink sur le couvercle, 450ml
Plastica | Plastic | Plástico | Plastique

☞ Ø 8,5 x 17 cm ☞ DP9 25 x 15 cm ☞ 1/40



05

.01

52011 *spartanburg*

Tazza thermos 400 ml | Thermal mug 400 ml | Taza térmica 400 ml | Mug thermique 400 ml
Plastica, alluminio | Plastic, aluminium | Plastico, aluminio | Plastique, alluminium

☞ Ø 8 x 18 cm ☞ L10 | T8 4 x 2 cm ☞ 25



.04

.05

.08

.06

74156 *nzilo*

Bicchiere 540 ml. | Cup, 540 ml | Vaso, 540 ml | Verre 540 ml
Acciaio inox | Stainless Steel | Acero inoxidable | Acier inox

☞ Ø 8,2 x 19,5 cm ☞ T8 | L10 3 x 3 cm ☞ 50



.04

.32

.05

.08

.01

52055 *garauso*

Tazza (320ml) in scatola singola. | Travel cup (320ml) | Taza de viaje | Tasse. Capacité 320ml en boîte individuelle.
Acciaio | Stainless steel | Acero | Acciaio inossidabile

☞ Ø 7,3 x 14,4 cm ☞ L10 | T5 5 x 2 cm ☞ 25



52096 *pátar*

Bicchiere 350ml con coperchio | Cup 350ml with top | Vaso 350ml con tapa | Verre 350ml avec couvercle
Acciaio inox, silicone | Stainless steel, silicon | Acero inoxidable, silicona | Acier inoxydable, silicone

☞ 10 x Ø 10 cm ☞ T8 | L10 5 x 2 cm ☞ 50

DRINKING *bottles*

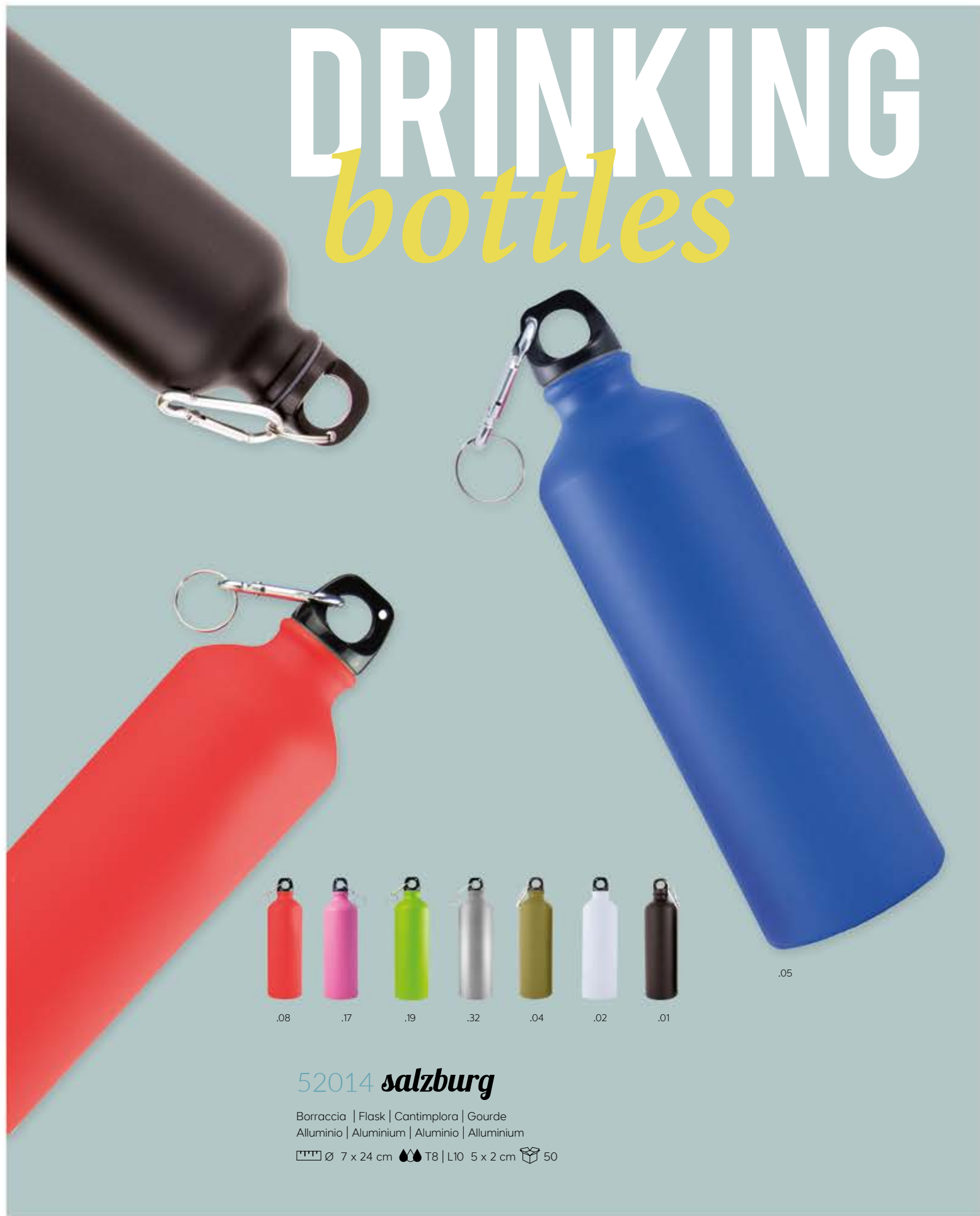

52014 *salzburg*

Borraccia | Flask | Cantimplora | Gourde
Alluminio | Aluminium | Aluminio | Alluminium
 Ø 7 x 24 cm T8 | L10 5 x 2 cm 50



52110 *alma*

Borraccia 400 ml | Drinking bottle, 400 ml | Bidón 400 ml | Gourde
400ml
Alluminio | Aluminium | Aluminio | Aluminium
 Ø 6,5 x 17,5 cm T8 | L10 4 x 2 cm 20/100



52056 *tjena*

Borraccia 500ml | Drinking bottle 500ml | Bidón 500ml | Gourde 500ml
Alluminio | Aluminium | Aluminio | Alluminium
 Ø 7 x 20 cm T8 | L10 6 x 3,5 cm 50

52098 *svalnäs*

Bottiglia per sublimazione, 500ml | Bottle for sublimation printing | Botella para sublimación | Bouteille pour sublimation
Alluminio | Aluminium | Aluminio | Alluminium
 Ø 7 x 20 cm SP3 8 x 11,5 cm 50



52094 *dano*

Borraccia 500 ml | Drinking bottle 500 ml | Bidón 500 ml | Gourde 500ml
 Metallo | Metal | Metal | Métal
 📏 6,5 x 21 cm 💧 T8 | L10 5 x 2 cm 📦 24/48



14020 *okinawa*

Tenda da campeggio | Quebec Tent | Tienda Quebec | Tente camping
 Poliestere 600D | Polyester 600D | Poliéster 600D | Polyester 600D
 📏 112 x 185 x 117 cm 📦 10



52090 *didler*

Borraccia, capacità 500 ml | Drinking bottle, 500 ml | Bidón 500 ml | Gourde 500 ml
 Alluminio | Aluminium | Aluminio | Aluminium
 📏 17,5 x 7,3 cm 💧 T8 | L10 5 x 2 cm 📦 48

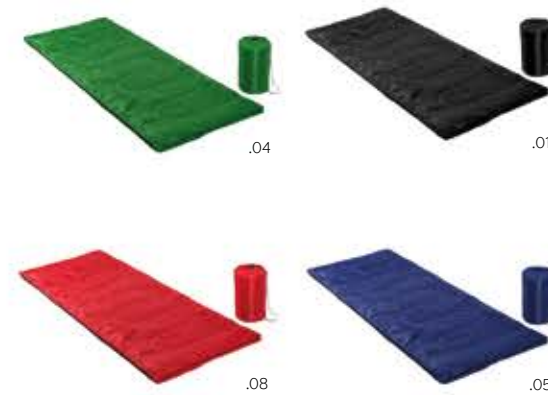

14012 *paterson*

Sacco a pelo | Sleeping bag | Saco de dormir | Sac de couchage
 Poliestere | Polyester | Poliéster | Polyester
 📏 185 x 75 cm 💧 S21 | TR29 10 x 5 cm 📦 10





leisure
584



.01

56102 *cedrino*

Set barbecue | Barbecue set | Set de barbacoa | Set barbecue
Poliestere 600D, Acciaio inox | Polyester 600D, Stainless steel | Poliéster
600D, Acero inoxidable | Polyester 600D Acier inox

21 x 4 x 39 cm S16 5 x 5 cm 10/20



.01

53045 *alowi*

Set barbecue | Barbecue set | Set barbacoa | Set barbecue
Metallo, Nylon | Metal, Nylon | Metal, Nylon | Métal, Nylon

41 x 27 cm S16 15 x 10 cm 1/12



.01

53009 *meika*

Set Barbecue. 7 Accessori | Barbecue Set. 7
Accessories | Set Barbacoa. 7 Accesorios | Set
barbecue. 7 Accessoires
Acciaio Inox, Poliestere 600D | Stainless Steel,
Polyester 600D | Acero Inox, Poliéster 600D | Acier
inox, Polyester 600D

43 x 78 cm S16 10 x 5 cm 1/20



.06



.04

.05

.08



.08



.02

.05

leisure
585

53001 *belice*

Barbecue | Barbecue | Barbacoa | Barbecue
Metallo | Metal | Metal | Métal

36 x Ø 36 cm T16 6 x 4 cm 1/4

52008 *leda*

Set posate, 3 pezzi | Cutlery set, 3 pieces | Set
cubiertos, 3 piezas | Couverts set, 3 pièces
Plastica | Plastic | Plástico | Plastique

3 x 17,6 x 2 cm T6 4 x 1 cm 50/400



95530 *josua*

Set giochi in scatola | Wooden game set | Set de juegos | Ensemble jeux en boîte
 Legno | Wooden | Madera | Bois

31 x 31 x 7 cm 🌳 S18 8 x 2 cm 📦 1/10



.00



.32

.11

.31

95045 *linde*

Medaglia | Medal | Medalla | Médaille
 Metallo | Metal | Metal | Métal

Ø 5 cm 🌳 L22 | D10 3 x 2 cm 📦 100/500



.00

95111 *siard*

Set gioco, 4-in-1, in scatola | 4 in 1 game set in box | Set de 4 juegos con ajedrez, damas, dominó, mikado y parchis presentado en caja | Set jeux 4 en 1 dans son coffret
 Legno | Wooden | Madera | Bois

19 x 13,8 x 3,1 cm 🌳 S2 | UV8 5 x 1,7 cm 📦 12/48

BINOCULARS & COMPASS



.06



.08

.01

.23

.04

56008 *iote*

Bussola con moschettone | Compass with carabiner
 | Brújula con mosqueton | Boussole mousqueton
 Plastica | Plastic | Plástico | Plastique

3 x 6,5 cm 🌳 T7 Ø 2 cm 📦 50/1000



.01

56322 *dani*

Bussola | Compass | Brújula | Boussole
 Metallo | Metal | Metal | Métal

7,5 x 5,7 x 2,3 cm 🌳 T7 3 x 1 cm 📦 12/144



.32

56321 *bendi*

Bussola | Compass | Brújula | Boussole
 Metallo | Metal | Metal | Métal

4,3 x 1 cm 🌳 T7 | L1 Ø 0,3 cm 📦 50/300



.32

.01

56111 *alois*

Macchina fotografica con flash, batterie escluse | Camera with flash, battery not included | Camara con flash, sin pilas | Appareil photo avec flash, batterie excluse
 Plastica | Plastic | Plástico | Plastique

12 x 6 x 4 cm 🌳 T8 | S93 4 x 1 cm 📦 10/40



.08

.06

.02

.05

56351 *lamishino*

Binocolo pieghevole | Binoculars | Prismáticos | Jumelles
 Cartoncino | Cardboard | Cartón | Carton

4,5 x 8 x 10,3 cm 🌳 S2 5 x 3 cm 📦 100/500

DOGS

our best FRIENDS

Ciotole per cibo e acqua portatili, bandane e collari per i nostri amici a quattro zampe.

588-593

dogs - cani - perros - chiens



59020 *largo*

Portacrocchette tascabile con moschettone | Feed pet food bowl with carabiner | Comedero plegable para mascotas con mosquetón | Bol pour chien avec mousqueton
Poliestere 600D | Polyester 600D | Poliéster 600D | Polyester 600D

15 x 10 cm (open) 6 x 6 cm 50



59020 *largo*

Portacrocchette tascabile con moschettone | Feed pet food bowl with carabiner | Comedero plegable para mascotas con mosquetón | Bol pour chien avec mousqueton
Poliestere 600D | Polyester 600D | Poliéster 600D | Polyester 600D

15 x 10 cm (open) 6 x 6 cm 50





52046 *cycas*

Bottiglia con scodella per cani | Dog water bottle | Bebedero portátil para mascotas | Gourde avec distributeur d'eau pour chien
Plastica | PET | Plastic, PET | Plástico, PET | Plastique, PET

10,4 x 5 x 5 cm 20 T20 4 x 1 cm 1/50

74098 *felton*

Ciotola per cani | Dog bowl for food and water | Plato para perro | Bol pour chien
Plastica | Plastic | Plástico | Plastique

20 x 20 x 6 cm T6 5 x 2 cm 40

74068 *ann*

Bowl per solidi e liquidi 1,3 lt | Folding food bowl, suitable for solid/liquid, 1,3 lt | Bowl plegable apto Solid/liquido, 1,3 lt | Bol pour solide et liquide 1,3 lt
Poliestere | Polyester | Poliéster | Polyester

16,5 x 16,5 x 10 cm S8 | TR1 5 x 5 cm

10/200

59000 *cheyenne*

Porta sacchetti con luce e moschettone | Waste bag dispenser and torch with carabiner | Dispensador de bolsas con linterna y mosquetón | Porte-sacs avec lumière et mousqueton
Plastica | Plastic | Plástico | Plastique

10,4 x 4,1 cm T7 3 x 1 cm 50/200



59005 *ory*

Osso con sacchetti usa e getta | Dog waste bag dispenser | Dispensador bolsas | Porte-sachets
Plastica | Plastic | Plástico | Plastique

8,5 x 4,5 x 4,5 cm T6 2 x 1 cm 200



59009 *krems*

Luce lampeggiante con moschettone. Pile incluse | Safety LED light with carabiner. Battery included | Luz reflectan con mosquetón. Incluye pila. | Lampe de signalisation avec mousqueton. Pile incluse.
Plastica | Plastic | Plástico | Plastique

4,8 x 3,1 x 1,6 cm T6 | UV2 2 x 1 cm 1/625

DOGS

592



19010 *eket*

Bandana per mascotte catarifrangente | Bandana for pets with reflective strip | Bandana para mascotas con tira reflectante | Bandana réfléchissante pour mascotte
Poliestere | Polyester | Poliéster | Polyester

20 x 14 cm 5 x 5 cm 20 / 400



.06



19006 *biff*

Bandana con collare | Bandana collar | Dog collar | Bandana
Poliestere | Polyester | Poliéster | Polyester

20 x 14 cm 5 x 5 cm 20/400



.02



.05

.08

.19

64143 *yelshanka*

Borsa pieghevole | Foldable bag | Bolsa plegable | Sac repliable
Poliestere | Polyester | Poliéster | Polyester

35,5 x 38,7 cm 15 x 15 cm 50/200



.08



.23

50018 *doc*

Frisbee
Cotone | Cotton | Algodon | Poliestere

Ø 19,7 cm 10 x 3 cm 10/150



593

TOOLS & TORCHES

equip your LIFE

Set utensili, coltellini multifunzioni, guanti e torce.
Metri e portachiavi, cutter, supporti da macchina per cellulari, raschiaghiaccio, gilet d'emergenza e molto altro ...

594 - 627

tools & torches - utensili e torce - brico - outillage et torches



.01



83030 vardagen

Torcia telescopica | Telescopic torch | Linterna telescópica | Lampe torche télescopique
Metallo | Metal | Metal | Métal

☞ Ø 2 x 57 cm (open) 🔋 L7 4 x 0,6 cm 📦 100



.01



.32

84013 lorens

Luce da esplorazione 4 led, batterie escluse | Head light, 4 LEDs, battery not included | Linterna para la cabeza con 4 luces LED Pilas no incluidas | Lumière d'exploration, 4 led batterie no incluse
Plastica | Plastic | Plástico | Plastique

☞ 5,3 x 4,1 x 3,9 cm 🔋 T7 2 x 1 cm 📦 20/200

83103 ypperlig

Torcia a 8 luci LED con banda elastica. Batterie incluse | Torch with 8 LED lights and elastic band. Batteries included | Linterna de 8 luces LED con banda elástica. Pilas incluidas | Torche 8 LED avec bande élastique. Batterie incluse
Plastica | Plastic | Plástico | Plastique

☞ 8 x 5,5 cm 🔋 3,5 x 1 cm 📦 100



.32

42039 *beatles*

Set utensili. | Tools set | Set herramientas | Set outils
Metallo | Metal | Metalico | Metal

20,5 x 2,8 x 14 cm S3 3 x 3 cm 5/20



.01



.03

82019 *tarak*

Set utensili 24 pz | Tools kit 24 pcs | Set de herramienta de 24 usd | Set outils 24 pièces
Metallo | Metal | Metal | Métal

19 x 12,5 x 9,5 cm T9 5 x 1 cm 20

82509 *saul*

Cassetta utensili con 25 pezzi | 25 pieces tool set | Caja herramientas con 25 piezas | Caisse ustensils avec 25 pièces
Plastica, metallo | Plastic, metal | Plástico, metal | Plastique, métal

15,5 x 10 x 5 cm S3 | AD7 4 x 2 cm 6/24



.01



82709 *älvängen*

Set utensili da 19 pezzi | 19 pieces tool set | Kit de herramientas 19 piezas | Set outils de 19pcs
Poliestere | Polyester | Poliéster | Polyester

15 x 10 x 2 cm



.01



82708 *askholmen*

Set utensili | Tool Set | Kit de herramientas | Set outils
ABS | ABS | ABS | ABS

Ø 12,8 x 4,8 cm T8



.05



.01

.08

86013 *jutta*

Coltellino 6 funzioni | Pocket knife, 6 functions | Navaja 6 funciones | Couteau de poche 6 fonctions
Acciaio inossidabile | Stainless steel | Acero inoxidable | Acier inoxydable

5,8 x 1,8 x 0,9 cm 🔋 T7 | UV3 2 x 0,5 cm 📦 20/600



.05



.01

.08

86014 *idita*

Coltellino 8 funzioni | Pocket knife, 8 functions | Navaja 8 funciones | Couteau de poche 8 fonctions
Acciaio inossidabile | Stainless steel | Acero inoxidable | Acier inoxydable

8,8 x 1,9 x 1,2 cm 🔋 T7 | UV3 2 x 0,5 cm 📦 10/200



.32

86052 *andi*

Coltellino | Multifunction knife | Navaja | Couteau de poche
Acciaio | Steel | Acero | Acier

7,5 x 2,6 x 0,6 cm 🔋 T8 | L7 3 x 1 cm

📦 72/288



.32

86008 *turku*

Coltellino portachiavi a forma di chiave | Key shaped pocket knife with key holder | Llavoro con mini navaja | Portecclés avec mini-couteau
Acciaio inox | Stainless steel | Acero inox | Acier inox

6 x 2,5 cm 🔋 L2 2 X 0,8 cm

📦 20/400



.00

71039 *genzone*

Coltellino in confezione | Creek knife in gift box | Navaja con caja de regalo | Couteau en boîte cadeau
Metallo, legno | Metal, wooden | Metalico, madera | Metal

8,5 x 2 cm 🔋 L7 2 x 1 cm 📦 12/216



.32

86017 *zara*

Coltellino multifunzioni. 11 funzioni. Con astuccio. Batterie per la torcia incluse | Multi-function knife (11 functions) with LED. With box | Navaja multifunción (11 funciones) LED incluido. Con estuche | Couteau multi-fonctions (11 fonctions) LED inclus. Avec etui
Metallo | Metal | Metal | Métal

2 x 9 x 2,7 cm 🔋 T8 | L7 3 x 1 cm 📦 100



.32

86001 *isidora*

Coltellino 10 funzioni | Pocket knife, 10 functions | Navaja 10 funciones | Couteau de poche 10 fonctions
Acciaio inossidabile | Stainless steel | Acero inoxidable | Acier inoxydable

9 x 2,5 x 1,8 cm 🔋 T8 | L7 2 x 1 cm 📦 12/120



.08



.04

.06

.05

71036 *crassula*

Coltellino multifunzione 9 funzioni. | Pocket knife, 9 function | Navaja 9 funcion | Couteau multifonction, 9 fonctions
Metallo | Metal | Metalico | Metal

7,3 x 2,1 x 1,3 cm 🔋 T7 2 x 0,8 cm 📦 12/216



.07

.01

86019 *lahti*

Coltellino multifunzioni. 8 funzioni. Batterie per la torcia incluse. Corredato di astuccio | Multi-function knife (8 accessories) | Navaja multifunción (8 funciones) | Couteau multi-fonctions (8 accessoires)
Acciaio inox | Stainless steel | Acero | Acier

9 x 2 x 2,3 cm 🔋 T8 | L24 2 x 1 cm 📦 10/120

SET TORCH & pocket knife



71001 *hidda*

Set torcia 1 LED e coltello 7 funzioni | Set with 1 LED torch and 7 functions pocket knife | Estuche con linterna 1 LED y navaja 7 funciones | Ensemble composé d'une torche avec 1 LED et un couteau de poche avec 7 fonctions
Alluminio | Aluminium | Aluminio | Alluminium

📏 9 x 13,5 x 2,7 cm 🔋 S27 | L11 5 X 5 cm 📦 10/100



86023 *malabo*

Pinza 9 funzioni in astuccio | 8 Functions multi pincher in pouch | Alicates 9 funciones con funda | Pince 9 fonctions dans étui
Acciaio inox, Alluminio | Stainless Steel, Aluminium | Acero inoxidable, Aluminio | Acier inox, Aluminium

📏 3,5 x 7 x 1,8 cm 🔋 T8 | L24 2 x 0,5 cm 📦 50/150

86048 *giave*

Pinza, 9 funzioni | Pincher, 9 functions | Pinza, 9 funciones | Pince, 9 fonctions
Acciaio | Steel | Acero | Acier

📏 6,5 x 4,7 x 1,5 cm 🔋 T8 | L24 2 x 1 cm 📦 10/100



81010 *prabir*

Guanti | Gloves | Guantes | Gants
Cotone | Cotton | Algodòn | Coton

📏 Unique size 🔋 TR23 4 x 2 cm 📦 10/200



CARPENTER pencil

Tools
604



25401 *benitez*

Matita da falegname | Carpenter pencil | Lápiz de carpintero | Rayon de menuisier
Legno | Wood | Madera | Bois

18 X 1 cm T1 | UV1 5 x 0,7 cm 100/1000



22131 *picos*

Penna a sfera con livella | Level ballpen | Bolígrafo con nivel | Stylo à bille avec niveau
Plastica | Plastic | Plástico | Plastique

14,9 x Ø 1 cm L2 3 x 0,5 cm 50/1000



.00

83055 *emay*

Blister Con 4 Batterie Ministilo AAA/R03 | 4 Batteries Pack AAA/R03 | Blister 4 pilas AAA/ R03 | 4 Piles AAA/R03

8,4 x 11,4 x 1,2 cm 12/1200



.00

83057 *ecom*

Blister Con 4 Batterie Stilo AA/R06 | 4 Batteries Pack AA/R06 | Blister 4 pilas AA/R6 | 4 Piles AA/R06

8,5 x 11,5 x 1,6 cm 12 | 960



①

.05



① 86133 *galant*

Cutter grande | Big cutter | Grande cutter | Grand cutter
Plastica | Plastic | Plástico | Plastique

15,5 x 1,4 cm T27

plastic CUTTER



.06

.01

.05



②

.08

② 86015 *biffus*

Cutter trasparente | Translucent cutter | Cutter transparente | Cutter transparent
Plastica | Plastic | Plástico | Plastique

13,3 x 2 x 1 cm T27 5 x 0,6 cm 100/1000



③

.02

③ 86024 *pacman*

Cutter grande | Big cutter | Grande cutter | Grand cutter
Plastica | Plastic | Plástico | Plastique

15 x 2,8 x 1 cm T27 5 x 1 cm

120/600

Tools
605



Tools
606

83000 ghilarza

Torcia 9 led | Flashlight 9 leds | Linterna | Lampe avec 9 LED
Alluminio | Aluminium | Aluminio | Aluminium

14 x 2,6 x 9 cm 🔋 T8 | L7 2 x 1 cm 📦 50/200



85007 maxwell

Torcia tascabile | Pocket torch in case, batteries included | Torche de poche
Metallo | Metal | Metal | Métal

17,5 x 6,4 x 3,5 cm 🔋 T8 | L7 5 x 2/3 x 0,6 cm 📦 12/72



85015 brita

Torcia multifunzione, 5 LED e 8 funzioni | Multifunction torch, 5 LED and 8 functions | Multifunción linterna, 5 LED y 8 funciones | Torche multifonction, 5 LED et 8 fonctions

Metallo | Metal | Metal | Métal

14 x 4,5 cm 🔋 T8 | L7 2 x 1 cm 📦 50/200



85003 plumby

Torcia, 6 Led, pila a bottone inclusa | Torch, 6 LED, botton cells included | Linterna, 6 LED, pila botón incluidas | Lampe de poche, 6 LED, pile bouton incluse

Alluminio | Aluminium | Aluminio | Aluminium

5 cm Ø 2,5 cm 🔋 T8 | L7 2 x 1 cm 📦 50/200



85046 miami

Pila con 6 LED | Flashlight. With 6 LEDs. 2 CR2032 batteries included | Linterna. Con 6 LEDs. Incluye 2 pilas CR2032 | Lampe de poche avec 6 LED (piles incluses)

Alluminio | Aluminium | Aluminio | Aluminium

2,8 x 4 x 2,8 cm 🔋 T8 | L7 1 x 1 cm 📦 70/280

Tools
607



.06



.01



.05

.08

.02

.19



.08



.08

.01

.05



.05

.04

.08



.32

.06

.24

.17

.05

.01

.04

47117 *peoria*

Portachiavi con luce | Two-tone Torch Keyring | Llavero linterna bicolor | Porte-clés avec torche 1 LED (piles incluses) | Plastica | Plastic | Plástico | Plastique

3,2 x 7,6 x 0,9 cm T7 UV2 3 x 1 cm 50/500

85081 *janeto*

Torcia, 3 LED, pila a bottone inclusa | 3 LEDs torch, button cell battery included | Linterna, 3 LED, pila botón incluidas | Lampe de poche, 3 LED, pile bouton incluse | Alluminio | Aluminium | Aluminio | Aluminium

6,2 cm Ø 1,7 cm L5 T4 2 x 0,8 cm 1/200

85048 *cerfoglio*

Lampada, batterie escluse | Light, Excl. batteries | Linterna sin baterias | Lampe - (3 x AAA) | Plastica | Plastic | Plástico | Plastique

ø 5,5 x 15,4 cm T8 3 x 1 cm 50/200

85014 *salil*

Torcia con moschettone, batteria inclusa | Torch with carabiner, battery included | Linterna con cierre de resorte, batería incluida | Torche avec mousqueton, batterie incluse | Alluminio | Aluminium | Aluminio | Aluminium

10,3 x Ø 1,5 cm L5 2 x 0,5 cm 100/600



.05



.08



.23



.04



.01

.08



.06

.01

.23



.01

.08



.08

.07

.05

.01

83001 *mateo*

Torcia tascabile con laccio da polso, 2 batterie AA escluse | Pocket torch with rubber grip and wrist string, 2 AA batteries excluded | Linterna con cinta trasparente, 2 baterias excluidas | Torche de poche avec lacet, 2 batteries esclues | Plastica | Plastic | Plástico | Plastique

Ø 4 x 16,5 cm T7 UV2 3 x 1 cm 1/200

85021 *axim*

Torcia a 2 Led magnetica. Pile Incluse | Torch. 2 Led. Magnet. Button Batteries Included | Linterna magnética de 2 led, pilas incluidas | Lampe. 2 Led. Aimanté. Piles Incluses | Plastica | Plastic | Plástico | Plastique

3,8 x 12,5 x 0,5 cm T7 UV2 4 x 1 cm 300

83002 *brandon*

Torcia tascabile con laccio da polso, corpo trasparente, carica pulsante a dinamo | Translucent torch, dynamo charging | Linterna carga manual con 2 luces LED. Funciona sin pilas | Torche de poche avec lacet, coque transparente, charge bouton à dynamo | Plastica | Plastic | Plástico | Plastique

10 x 5 x 2,5 cm T7 UV17 3 x 2 cm 50/200

83016 *chandler*

Torcia dinamo con 3 LED | Dynamo Torch with 3 LEDs | Linterna dinamo 3 LED | Lampe dynamo 3 LED | Plastica | Plastic | Plástico | Plastique

10 x 5 x 2,5 cm T7 UV17 2 x 3 cm 50/200



2 MT tape

Tools
610

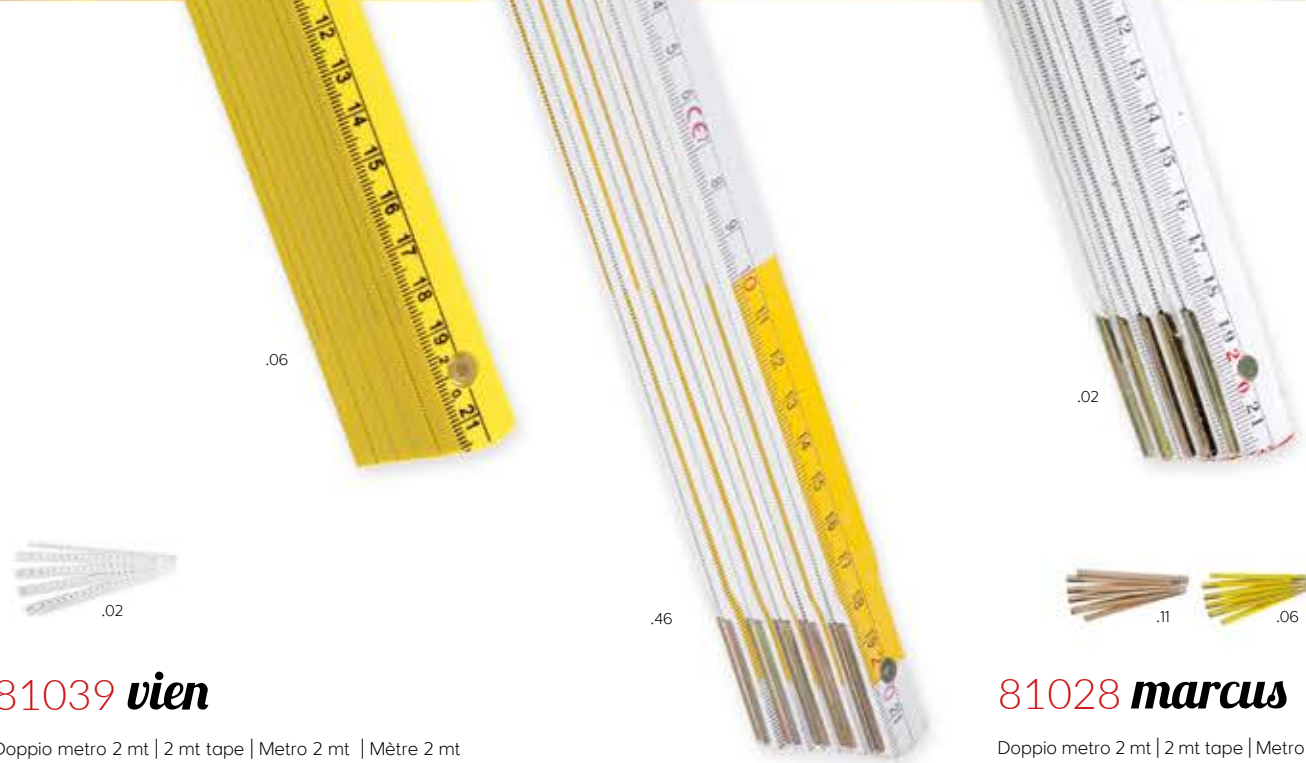

81039 *vien*

Doppio metro 2 mt | 2 mt tape | Metro 2 mt | Mètre 2 mt
Fibrosina, Plastic

23 cm T6 5 x 0,85 | S85 18 x 2 cm | UV9 18 x 2 cm
5 x 0,5 cm 12/144

81020 *bleiza*

Doppio metro 2 mt | 2 mt tape | Metro 2 mt | Mètre 2 mt
Legno | Wood | Madera | Bois

23 cm T6 5 x 0,5 cm 12/144

81028 *marcus*

Doppio metro 2 mt | 2 mt tape | Metro 2 mt | Mètre 2 mt.
Legno | Wood | Madera | Bois

23 cm T6 5 x 0,5 cm 12/144

MEASURING tape



81001 *pskov*

Flessometro 5 metri | 5 meters measuring tape | Flexómetro 5 metros
| Mètre flexible 5 mètre
Plastica | Plastic | Plástico | Plastique

7 x 7 x 3,5 cm T8 Ø 2 cm 10/50

81789 *knoppäng*

Flessometro da 3 metri | Measuring tape 3 meters | Flexómetro de 3 metros |
Mètre ruban 3mt
Plastica | Plastic | Plástico | Plastique

6 x 6 x 3 cm T8 Ø 2 cm 10/50



47073 jonh

Portachiavi con metro da sarta (1,5mt) | 1,5 mt.measuring tape with keyring | Llavero con metros de sastrer (1,5mt) | Portecclés avec mètre pour tailleur (1,5mt)
Plastica | Plastic | Plàstico | Plastique

720 6 x 4,8 x 1,5 cm T6 | UV2 Ø 3,5 cm

.02



.06



.08

.01

81009 leida

Flessometro | Measuring tape | Flexòmetro | Mètre flexible
Plastica | Plastic | Plàstico | Plastique

12/120 7 x 6 x 2,5 cm T8 3 x 1 cm

81042 fantig2

Flessometro con bottone di arresto e clip per cintura | 2 mt measuring tape with stop button and belt clip | Flexómetro homologado con clip | Mètre flexible avec bouton d'arrêt et accroche pour ceinture
Plastica, metallo | Plastic, metal | Plàstico, metal | Plastique, métal

12/120 6,5 x 5,5 x 2,5 cm T8 2 x 2 cm



.06

81043 fantig3

Flessometro con bottone di arresto e clip per cintura | 3 mt measuring tape with stop button and belt clip | Flexómetro homologado con clip | Mètre flexible avec bouton d'arrêt et accroche pour ceinture
Plastica, metallo | Plastic, metal | Plàstico, metal | Plastique, métal

12/120 6,5 x 5,5 x 2,5 cm T8 2 x 2 cm

81032 cesari2

Flessometro con bottone d'arresto | 2 mt.measuring tape with stop button and belt clip | Flexómetro de 2 metros con freno | Mètre flexible 2 m avec bouton d'arrêt

Plastica | Plastic | Plàstico | Plastique

12/120 7 x 6 x 2,2 cm T8 3 x 1 cm

81033 cesari3

Flessometro con bottone d'arresto | 3 mt.measuring tape with stop button and belt clip | Flexómetro de 3 metros con freno | Mètre flexible 3 m avec bouton d'arrêt

Plastica | Plastic | Plàstico | Plastique

12/120 7 x 6 x 2,2 cm T8 3 x 1 cm

81035 cesari5

Flessometro con bottone d'arresto | 5 mt.measuring tape with stop button and belt clip | Flexómetro de 5 metros con freno | Mètre flexible 5 m avec bouton d'arrêt

Plastica | Plastic | Plàstico | Plastique

12/120 7 x 6 x 2,2 cm T8 3 x 1 cm



.23



47135 *apatite*

Portachiavi con metro pieghevole 50cm | Keyring with meter 50cm | Llavero con metro 50cm | Porte-clés avec mètre pliable 50cm
Plastica | Plastic | Plástico | Plastique

🔧 T11 3,5 x 2 cm 📦 50/200



.02



.02

47097 *tungar*

Flessometro 1 mt. | Measuring tape 1 mt. | Flexòmetro 1 mt. | Mètre flexible 1 mt.
Plastica | Plastic | Plástico | Plastique

📏 5,5 x 4 x 1 cm 🔧 T11 | UV1 2 x 1 cm 📦 100/500

Tools
614



.01

.08

.04

.05

83100 *askvoll*

Flessometro 1 m con portachiavi | Measuring tape with keyring
| Flexómetro de 1 m con llavero | Mètre ruban 1m avec porteclé
ABS | ABS | ABS | ABS

📏 4,3 x 4,1 x 1,5 cm 🔧 T6



.06

.02

.04



.05

47075 *dirking*

Portachiavi con metro (1mt) | 1 mt measuring tape with keyring | Llavero con metros (1mt) | Porteclés avec mètre (1mt)
Plastica | Plastic | Plástico | Plastique

📏 4 x 4 x 0,9 cm 🔧 T11 | UV1 2,5 x 2,5 cm 📦 50/500



.01

47014 *udilo*

Portachiavi ruota con metro (1mt) | Wheel shaped 1 mt. keyring | Llavero en forma de rueda con metros (1mt) | Porteclés en forme de roue avec mètre (1m)
Plastica | Plastic | Plástico | Plastique

📏 Ø 4 cm 🔧 T6 | D2 Ø 2,5 cm 📦 1/500

Tools
615

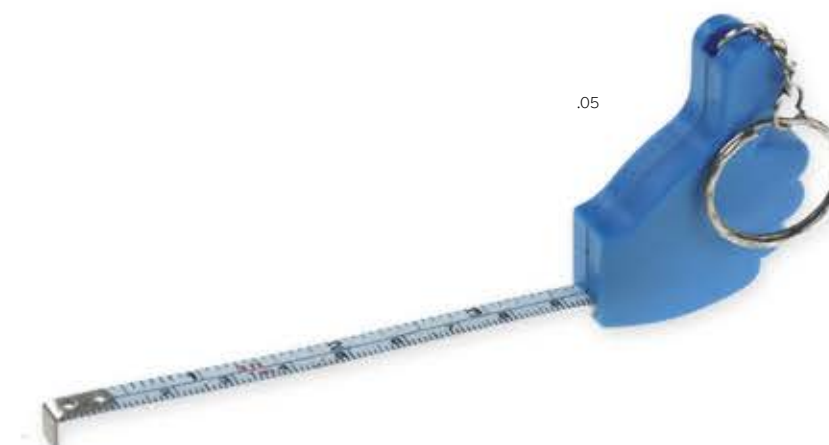

.05



.02

47007 *alfret*

"OK", 1 metro, con portachiavi | 1 mt measuring tape with keyring | Flexómetro de 1 metro en forma de dedo con llavero | Mètre flexible OK, 1m, avec fonction porteclés

Plastica | Plastic | Plástico | Plastique

📏 5,7 x 4 x 1 cm 🔧 T11 | UV1 2,5 x 1 cm 📦 50/1000



29242 rancher

Supporto per cellulare da macchina. | Phone holder. | Soporte para el móvil | Support pour portable de voiture
ABS | ABS | ABS | ABS

5 x 9,7 x 2,8 cm T7 1 x 1 cm 50/200



88076 gordona

Supporto da macchina per cellulare con rompivetro | Phone holder for car with glass breaker | Soporte para el móvil con punzón rompe cristales de emergencia | Support de voiture pour portable avec brise-vitre
Plastica | Plastic | Plástico | Plastique

10 x 3 x 5 cm T7 1 x 1 cm 50/150

PHONE holder



59013 grimmy

Supporto portatutto | Holder | Supporto | Support
Plastica | Plastic | Plástico | Plastique

7 x 4,8 x 2,7 cm T7 3 x 1 cm 10/500



82537 anfus

Lente d'ingrandimento | Magnifier | Lupa | Lentille d'agrandissement
Plastica | Plastic | Plástico | Plastique

3 x 4 x 4 cm T7 1,5 x 1,5 cm 50/400



83017 nika

Torcia con funzione dimmer, con illuminazione fissa e a intermittenza e con gancio appendino. | LED Torch with permanent or flashing mode | Linterna con LED y 2 opciones de iluminación: permanente o intermitente. | Lampe électrique à variateur de lumière avec illumination fixe et clignotante et crochet.

Plastica | Plastic | Plástico | Plastique

3,8 x 10 cm T8 2 x 1 cm 50/100



83101 cårgångårstid

Torcia magnetica 3 posizioni con moschettone. Batterie incluse | Magnetic torch with carabiner. 3 positions. Batteries included | Linterna magnética 3 posiciones con mosquetón. Baterías incluidas | Torche magnetique 3 positions avec mousqueton. Batteries incluse

3,3 x 7 x 2,1 cm T6



SCRAPER ice



.05



.21



.08



.07

88001 *tomas*

Raschiaghiaccio | Ice scraper | Rascador de hielo | Racle-glace
Plastica | Plastic | Plástico | Plastique

📏 22 x 10,8 x 1 cm 💧 T6 | UV9 4 x 2 cm 📦 50/200



.19



.23



.08

88023 *satya*

Raschiaghiaccio | Ice scraper | Rascador de hielo | Racle-glace
Plastica | Plastic | Plástico | Plastique

📏 12 x 11 x 0,3 cm 💧 T6 | UV9 4 x 2 cm 📦 25/400



.08

.23

.01

88005 *pralfio*

Raschiaghiaccio con guanto | Ice scraper nylon glove | Rascador de hielo con guante | Racle-glace avec gant
Plastica | Plastic | Plástico | Plastique

📏 16 x 1 x 24 cm 💧 S8 6 x 6 cm 📦 50/100



.02

88007 *blas*

Raschiaghiaccio | Ice scraper | Rascador de hielo | Racle-glace
Plastica | Plastic | Plástico | Plastique

📏 15,5 x 10 x 1,5 cm 💧 T6 | UV9 5 x 2 cm 📦 100/500



.05

88042 *norman*

Raschiaghiaccio con disco orario | Ice scraper and parking disc | Disco de aparcamiento con rascador de hielo | Raclair à glace et disque horaire
Plastica | Plastic | Plástico | Plastique

📏 11,5 x 12 x 0,6 cm 💧 T6 4,5 x 5 cm 📦 1/200

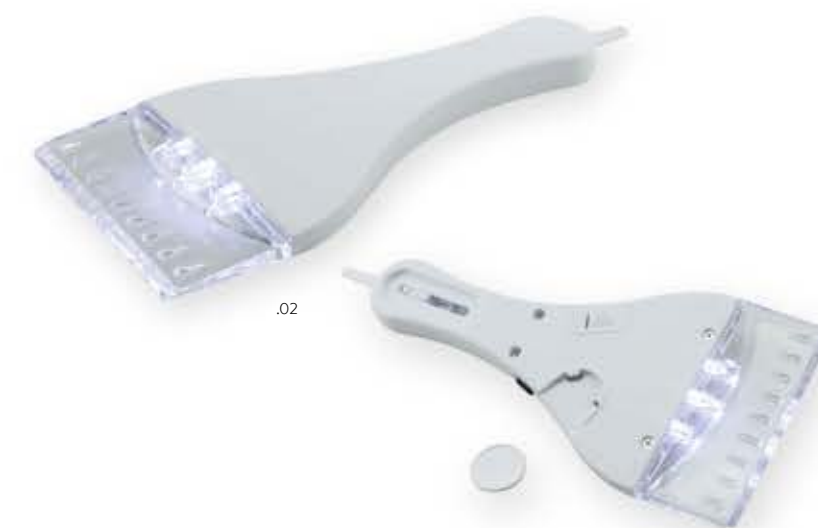

.02

88083 *gorno*

Raschia ghiaccio con gettone, LED e misuratore pressione gomme. | Ice Scraper with coin, LED and tire pressure calculator | Rascador de hielo con moneda para el carro del supermercado, LED y medidor presión neumáticos | Racle glace avec jeton, lumière LED et mesureur de pression pneus.
Plastica | Plastic | Plástico | Plastique

📏 21 x 9,7 x 1,5 cm 💧 T6 3 x 2 cm 📦 50/100



.01

88016 *scream*

Martello da auto | Emergency hammer | Martillo SOS | Martelo SOS
Plastica, metallo | Plastic, metal | Plástico, metal | Plastique, métal

8 x 1,5 x 13 cm T8 2 x 1 cm 100



.02

88084 *krusiduller*

Misuratore alcohol. 2 batterie AAA non incluse | Alcohol tester. 2 AAA batteries not included | Alcoholímetro. 2 pilas AAA no incluidas | Testeur d'alcool. 2 piles AAA non incluses

Plastica | Plastic | Plástico | Plastique

3,6 x 9,5 x 1,7 cm 92



SQUEEGEE sprayer

Tools
620



.02

45000 *gaiola*

Portachiavi con misuratore pressione gomme | Keyring with tires pressure calculator. | Llavoro con medidor de presión de neumáticos | Portecleç avec mesureur pression pneus

Plastica | Plastic | Plástico | Plastique

10 x 3,2 x 0,5 cm T8 2 x 1 cm 50/500

Tools
621



.05

88071 *scandeck*

Portachiavi - Manometro | Kej holder - Keyring with pressure gauge | Llavoro - Medidor presión | Porte clès - Mesureur de pression

Alluminio | Aluminium | Aluminio | Aluminium

Ø 0,8 x 8 cm L5 4 x 0,6 cm 100/1000



.08

85071 *loulou*

Luca lampeggiante | Flashing light | Luz intermitente | Lumière clignotante

Plastica | Plastic | Plástico | Plastique

Ø 4,5 cm T6 Ø 2 cm 500



.02

88077 *gorla*

Lava vetri con vaporizzatore | Squeegee with sprayer | Limpia cristales con cargador de líquido limpiador | Raclette lave vitre avec vaporisateur

Plastica | Plastic | Plástico | Plastique

25,5 x Ø 2,8 cm T8 3 x 1 cm 10/50



.06

.23

.02

.08

.01

47113 *campanula*

Profumatore per auto. Aroma Limone | Air Freshener. Lemon Aroma | Perfumador de coche de plástico con aroma limón | Déodorant de voiture. Arôme citron

Plastica | Plastic | Plastica | Plastic

4,2 x Ø 5,2 cm T6 400



.06



.06

88006 burgo

Gilet d'emergenza | Promotional safety jacket | Chaleco reflectante | Gilet d'urgence
Poliestere | Polyester | Poliéster | Polyester
Taglia unica - Unique size

54 x 62 cm S41 | TR14 15 x 15 cm 1/120

88003 garu

Gilet d'emergenza per bambini, omologato | Promotional Safety jacket for children
| Chaleco reflectante para niños | Gilet d'urgence pour enfants, garantis
Poliestere | Polyester | Poliéster | Polyester
Taglia unica - Unique size

37 x 47 cm S41 | TR14 17 x 17 cm 1/120

622
tools



88049 taku

Giubbotto riflettente | Adult reflective vest | Chaleco reflectante adulto | Veste réfléchissante
Poliestere | Polyester | Poliéster | Polyester

One size (Adult) S30 9 x 9 cm / 20 x 10 cm 20/100



.05



88078 raidi

Gilet d'emergenza | Promotional safety jacket | Chaleco reflectante | Gilet d'urgence
Poliestere | Polyester | Poliéster | Polyester
Taglia unica - Unique size

57 x 58 cm S41 | TR14 20 x 20 cm 1/120



.06

64178 guidonia

Copri zaino riflettente e impermeabile | High visibility bag cover | Funda reflectante e impermeable para mochila | Housse pour sac à dos réfléchissante
Poliestere 210d | Polyester 210d | Poliéster 210d | Poliéster 210d

66 x 77 cm S41 10 x 10 cm 25/200



.06



.06

88035 patri xl

Gilet d'emergenza, omologato EN471 | Promotional safety jacket certified | Chaleco reflectante naranja, según norma EN 471 | Gilet d'urgence, garantis
Poliestere | Polyester | Poliéster | Polyester

XL S30 | TR13 9 x 9 / 20 x 10 cm 25/100

88031 ruben s

Gilet d'emergenza per bambini, omologato EN471 | Promotional Safety jacket for children, yellow certified | Chaleco reflectante para niños, amarillo | Gilet d'urgence pour enfants, garantis
Poliestere | Polyester | Poliéster | Polyester

XS, S S30 | TR13 7 x 7 / 15 x 10 cm 25/100



Tools
624



.06

45012 *light*

Portachiavi riflettente modello gilet | Gilet shaped reflective tag with carabiner | Llavero reflectante con mosquetón | Portecclés reflectante modèle gilet
Plastica | Plastic | Plástico | Plastique

📏 5,6 x 4,5 cm 💧 T11 2 x 2 cm 📦 100/1000



.06

45001 *saba*

Portachiavi riflettente modello gilet | Gilet shaped reflective tag with carabiner | Llavero reflectante con mosquetón | Portecclés reflectante modèle gilet
Plastica | Plastic | Plástico | Plastique

📏 5,6 x 4,5 cm 💧 T11 2 x 2 cm 📦 100/1000



.06

45023 *klivia*

Adesivo riflettente | Reflective sticker | Pegatina reflectante | Autocollant réfléchissant
Plastica | Plastic | Plástico | Plastique

📏 Ø 7 cm 💧 T27 3 x 1,5 cm 📦 1000



.06

88021 *paddington*

Fascia da braccio riflettente | Reflective snap armband | Pulsera reflectante, flexible y ajustable | Bracelet reflectant
Plastica | Plastic | Plástico | Plastique

📏 One size (Adult) 💧 T6 6 x 1,5 cm 📦 1/1000



.06

47123 *arz*

Portachiavi riflettente con moschettone | Reflective keyring with carabiner | Llavero reflectante con mosquetón | Porte-clés réfléchissant avec mousqueton
PVC, Alluminio | PVC, Aluminium | PVC, Aluminium | PVC, Aluminium

📏 28 x 3,2 cm 💧 S2 5 x 1,8 cm 📦 50/300

Tools
625



SUNSHADE *car*

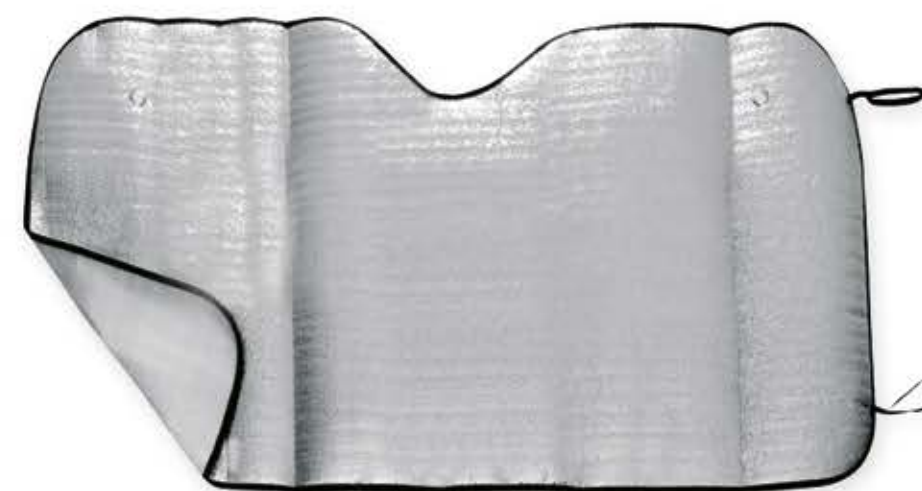

88061 *amat*

Parasole metallizzato | Car window sunshade, maxi size
| Parasol | Parasol métalisé
Alluminio | Aluminium | Aluminio | Aluminium

☞ 130 x 60 cm ☞ S19 60 x 25 cm ☞ 1/100

.32



.01



.02

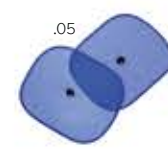

.05

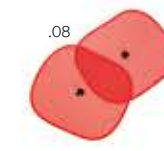

.08

88009 *kun*

Parasole con custodia | Car window sunshades in pouch | Parasol con funda
| Pare soleil
Poliestere | Polyester | Poliéster | Polyester

☞ 44 x 37 cm ☞ S20 15 x 12 cm ☞ 1/120



.32

88010 *car*

Parasole metallizzato per volante | sunshade | Cubrevolante | Couvre
volant
Alluminio | Aluminium | Aluminio | Aluminium

☞ Ø 43 cm ☞ S6 Ø 30 cm ☞ 1/100

FITNESS

shape your LIFE

Cronometri, contapassi, borracce e shaker. Asciugamani con tasca da palestra, copri sellini per bici e kit utensili. Casacche sportive, polsiere, zaini e borsoni. Occhiali da sole e gadget.

628 - 675

sport and fitness



.01



64205 *ortice*

Zaino con uscita per auricolari, tasche mesh laterali e schienale rinforzato | Backpack for daily and sport use. Side mesh headphones out, elastic slide and padded back | Mochila para uso diario y deportivo. Malla lateral auriculares, dispositivo elástica y espalda acolchada | Sac à dos pour un usage quotidien et sportif. Maille latérale, casque d'écoute, glissière élastique et dos rembourré

Poliestere 600D | Polyester 600D | Poliéster 600D | Polyester 600D

29 x 14 x 40 cm 🚰 S78 14 X 9 cm 📦 1/40



.05



.08



.05

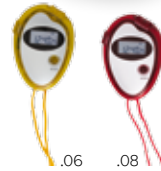

.06

.08



.02



.08



.04

.02

.06

.07

.17

.23

.01

35031 charlotte

Cronometro. Batteria inclusa | Stopwatch. Battery included | Cronómetro. Pila Botón Incluida | Chronomètre. Pile incluse
Plastica | Plastic | Plástico | Plastique

5 x 7,5 x 2,1 cm T7 UV16 2 x 1 cm

50/200

48149 barnyard

Pedometro con clip. | Pedometer | Podómetro | Podomètre avec clip
Plastica | Plastic | Plástico | Plastique

5,5 x 1 x 4 cm T7 1 x 1 cm 50/200

48044 asbest

Contapassi | Step counter | Podómetro | Pédomètre
Plastica | Plastic | Plástico | Plastique

3,6 x 5,6 x 2 cm T7 2,5 x 1 cm 100/200



.08

.06

.05

.04

.02

52090 hindö

Borraccia sportiva 600ml | Sports drinking bottle 600ml | Botella deportiva 600ml | Gourde sportive 600ml
Plastica | Plastic | Plástico | Plastique

22,50 x Ø 7,20 cm T20 100



.17

.07

.23

.19



.05

.04

.08

.02

52036 ronde

Borraccia. Capacità: 500 ml. | Drinking bottle. Capacity: 500 ml. | Botella deportiva. Capacidad: 500 ml. | Bouteille. Capacité: 500 ml
Plastica | Plastique | Plastic | Plástico

22,5 x 7,2 cm T20 S92 5 x 2 cm 20/100

52049 godrano

Borraccia con laccio 500 ml | Water bottle 500 ml | Bidón 500 ml | Gourde avec lacet 500 ml
PET BPA free | PET BPA free | PET BPA free | PET BPA free

20 x Ø 6,8 x cm T20 3 x 3 cm 1/50



.02

.01

.06



.08

.04

.05

48175 olomega

Pedometro con contapassi | Pedometer with calculates steps | Podómetro con calcula pasos | Podomètre avec calcule pas
Plastica | Plastic | Plástico | Plastique

4,1 x 6,6 x 2,5 cm T7 1,5 x 1,5 cm

100 / 200

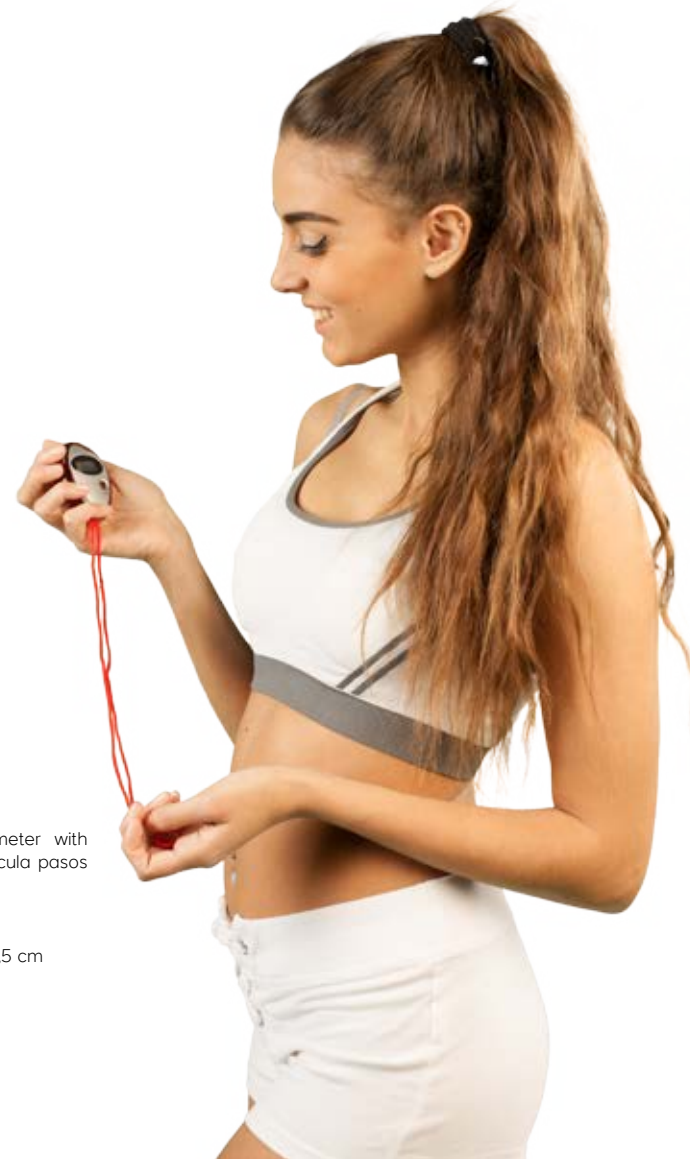



52052 *zimpambo*

Borraccia con infusore, 700 ml | Bottle, 700 ml | Bidon, 700 ml
| Bidon, 700 ml
Tritan | Tritan | Tritan | Tritan

☞ 7 x 24,5 cm ☞ T20 3 x 3 cm 📦 50

52062 *förhöja*

Bottiglia 780 ml | Bottle 780 ml | Botella 780 ml | Bouteille en titanium 780ml
Tritan | Tritan | Tritan | Tritan

☞ 24,7 x 7 cm ☞ T6



52507 *friskhet*

Bottiglia 750 ml con spremiagrumi e beccuccio | Juicer bottle 750 ml with
spout | Botella 750 ml con exprimidor manual y pitorro | Bouteille 750ml avec
centrifugeuse et bec verseur
Tritan | Tritan | Tritan | Tritan

☞ 26,5 x 7,5 cm ☞ T20

52504 *förtrolig*

Bottiglia 750 ml con spremiagrumi | Juicer bottle 750 ml | Botella 750 ml
con exprimidor manual | Bouteille 750ml avec centrifugeuse
Tritan | Tritan | Tritan | Tritan

☞ 25 x 7,3 cm ☞ T20



52030 *atocia*

Borraccia 500 ml | Drinking bottle 500 ml | Botella 500 ml | Gourde 500 ml
Plastica | Plastic | Plástico | Plastique

19 x Ø 6,5 cm T20 | S92 4 x 4 cm 10/100

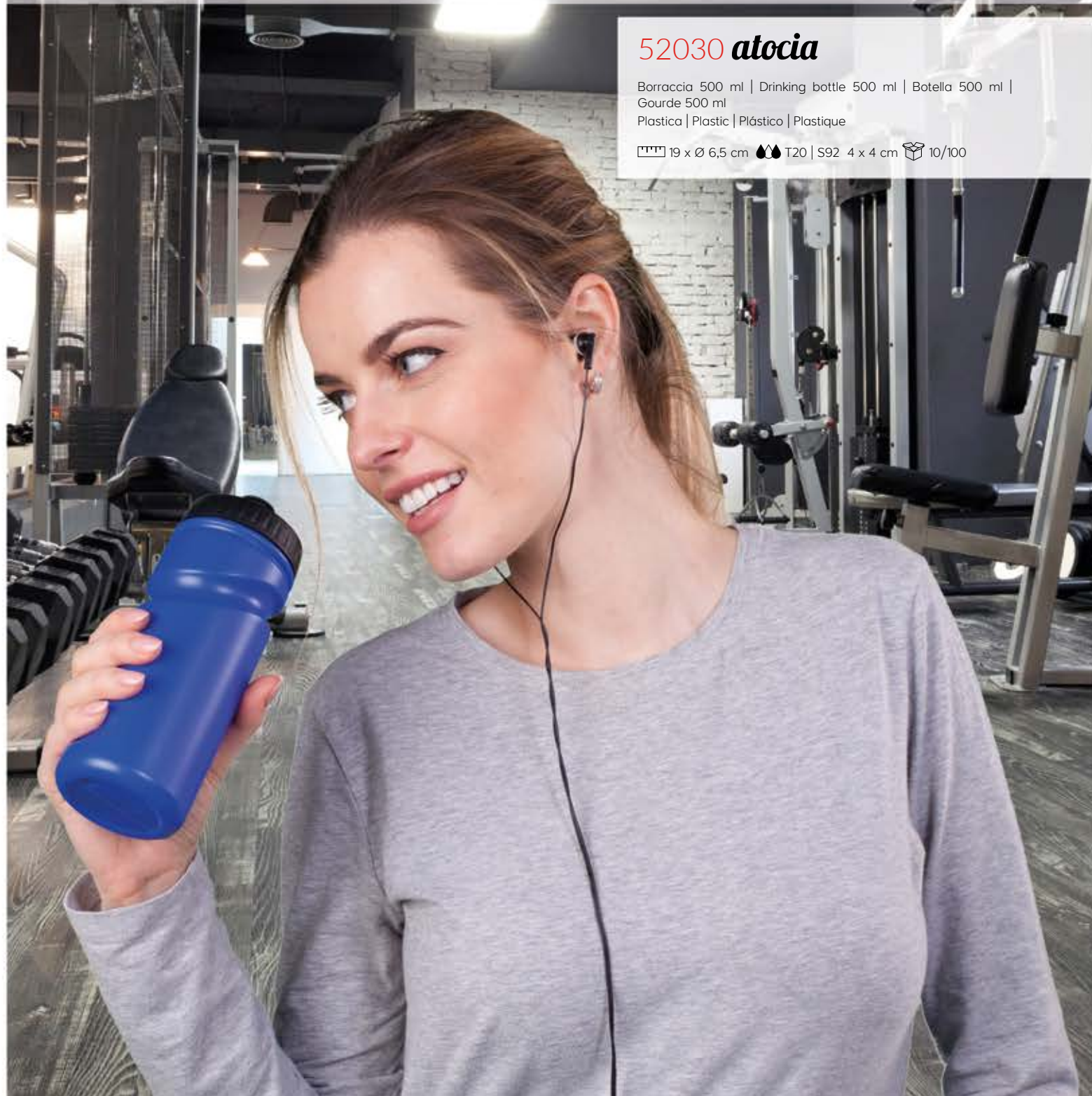

52005 *provide*

Borraccia 500 ml | Drinking bottle 500ml | Botella 500 ml | Gourde 500 ml
Plastica | Plastic | Plástico | Plastique

20 x Ø 7,5 cm T20 | S92 4 x 4 cm 10/100

52039 *wendy*

Borraccia | Drinking bottle | Botella | Gourde
Plastica | Plastic | Plástico | Plastique

20 x Ø 6,5 cm T20 | S92 4 x 4 cm 1/100



52045 *petersburg*

Borraccia pieghevole 480 ml | Foldable drinking bottle 480 ml | Bidón plegable 480 ml | Gourde pliable 480 ml
PE

11 x 21,8 x 6,4 cm S91 5 x 5 cm 300

52059 *fitri*

Borraccia pieghevole, 500 ml | Bottle, 500 ml | Bidon, 500 ml | Bidon, 500 ml
PET

25,5 x 17 x 3,3 cm S91 5 x 5 cm

50 / 400

52060 *iro*

Borraccia pieghevole, 550 ml | Bottle, 550 ml | Bidon, 550 ml | Bidon, 550 ml
PET

21 x 16 x 3,3 cm S91 4 x 4 cm 50 / 400



52032 lorry

Borraccia trasparente | Drinking bottle | Botella | Gourde transparente
Plastica, Acciaio inossidabile | Plastic, Stainless steel | Plástico, Acero inoxidable
| Plastique, Acier inoxydable

22 x Ø 6 cm T20 | L10 3 x 3 cm 1/50



52501 gallipoli

Borraccia con tappo | Sport bottle with cap | Bidón con tapón | Gourde
Alluminio | Aluminium | Aluminio | Aluminium

25 x Ø 7 cm T8 | L10 5 x 2 cm 25/50



52037 peno

Borraccia 400 ml | Drinking bottle 400 ml | Bidón 400 ml |
Gourde 400 ml
PP

22 x Ø 1 cm T20 5 x 2 cm 10/100

SPORT Bottle



52001 ryan

Borraccia, 400 ml, dotata di bussola e sistema pack freezer | Drinking bottle,
400ml, with compass and freezer pack | Bidón de 400 ml con brújula y elemento
refrigerador | Gourde 400 ml, dotée d'une boussole et d'un système freezer
Plastica | Plastic | Plástico | Plastique

20 x Ø 6 cm T20 3 x 3 cm 1/60



52000 axe

Bottiglia a soffietto con moschettone | Foldable drinking bottle with carabiner.
Capacity: 600 ml. | Botella plegable con mosquetón. Capacidad: 600 ml |
Bouteille pliable avec mousqueton
PE

18,5 x Ø 9,3 cm T20 4 x 1 cm 50



52476 cicuta

Shaker 600ml | Shaker 600ml | Coctelera 600ml | Agitateur 600ml
Plastica | Plastic | Plástico | Plastique

22 x Ø 9,5 cm T20 5 x 2 cm 1/50



COOLING Feel

50 °C



15 °C



.05



.08



.02



.01

18871 avsiktlig

Asciugamano rinfrescante. Protezione UV50 | Cooling feel towel UV50 Protection | Toalla refrescante. Protección UV50 | Serviette rafraichissante. Protection UV50

Microfibra 160 gr/m2 | Microfiber 160gsm | Microfibra 160 gr/m2 | Microfibre 160gr/m2

30 x 90 cm 🚰 T20



.17



.19



.08



.05



18060 chilwa

Asciugamano freddo/caldo con protezione SPF | Instant cool towel with SPF protection | Toalla instant cool | Serviette instant cool

Nylon, Poliestere | Nylon, Polyester | Nylon, polyester | Nylon, polyester

90 x 30 cm 🚰 S99 15 x 10 cm 📦 100



29257 *birket*

Tappetino | Mat | Moqueta | Tapis
PE

45 x 45 cm S6 10 x 10 cm 10 / 100



18038 *aramis*

Asciugamano con tasca sul fondo | Towel with pocket | Toalla con bolsillo interior | Serviette

Microfibr | Microfibre | Microfibre | Microfibre

25 x 100 cm S96 | TR3 10 x 10 cm 200



18059 *amaramba*

Asciugamano sportivo | Sport towel | Toalla deportiva | Serviette

Microfibr 290gr | Microfiber | Microfibr | Microfibre

120 x 60 cm S5 5 x 5 cm 72



18052 *poltsamaa*

Asciugamano con sacchetto | Towel with pouch | Toalla con funda | Serviette de toilette

Microfibr 160 gr/m² | Microfiber 160 gr/m² | Microfibr 160 gr/m² | Microfibre 160 gr/m²

100 x 50 cm S99 (towel) 100

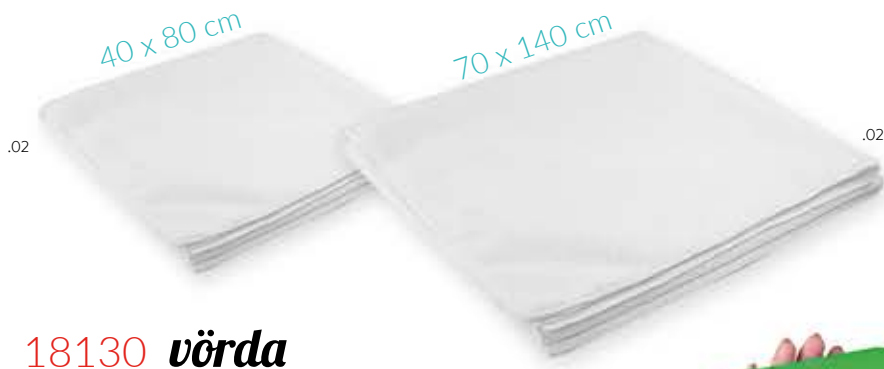

18130 *vörda*

Telo per sublimazione | Sublimation towel | Toalla sublimática | Nette pour sublimation

Poliestere 200gr

70 x 140 cm SP41 20

18511 *iguaque*

Telo per sublimazione | Sublimation towel | Toalla sublimática | Nette pour sublimation

80% Poliestere, 20% Poliamide

40 x 80 cm 60



Ideal for sublimation



18036 *oranjestad*

Asciugamano | Towel | Toalla absorbente | Serviette absorbante

Microfibr | Microfiber | Microfibr | Microfibre

30 x 70 cm S99 (towel) | DP6 10 x 10 cm 200



18049 *poipet*

Asciugamano | Towel | Toalla | Serviette de toilette

Microfibr 310 gr/m² | Microfiber 310 gr/m² | Microfibr 310 gr/m² | Microfibre 310 gr/m²

45 x 30 cm S93 (bag) | S99 (towel) 10 x 10 cm 100



50093 *kehra*

Copri sellino per bicicletta | Bicycle soft cover for seat | Funda para sillín bicicleta | Couvre-selle pour bicyclette
 Poliestere 190T | Polyester 190T | Poliéster 190T | Polyester 190T

22 x 22 x 7 cm S2 12 x 7,5 cm 1/400



57123 *warta*

Kit utensili | Tool kit | Kit herramientas | Kit outils
 Metallo, ABS | Metal, ABS | Metal, ABS | Métal, ABS

8,5 x 2,8 x 4,5 cm S93 2 x 2 cm 50/100



88047 *mare*

Casacca sportiva adulto | Adult sport bib | Peto sportivo adulto | Chasuble sportif adulte
 Non-Woven

Taglia unica | One size | Un tamaño | Taille unique S41 | TR14 25 x 25 cm 25/300

sport bib

Fitness
642



85037 *gundam*

Luce riflettente con 2 modalità e luce LED | Safety light with 2 modes LEDs
 | Luz a LED reflectante con 2 modos | Lumière réfléchissante avec 2 leds et deux modalités

Plastica | Plastic | Plástico | Plastique

6,3 x 8,9 x 2,8 cm T7 1 x 1 cm 50/200



85039 *cirsium*

Bracciale luminoso | Braciale with light | Brazalete con luz | Bracelet avec lumière

Plastica | Plastic | Plástico | Plastique

9,5 x 4 x 1,5 cm T7 6 x 1 cm 50/200

Fitness
643



88019 *tobias*

Casacca sportiva bimbo | Kids sports bib | Dossard niño | Chasuble sportif enfant

Poliestere | Polyester | Poliéster | Polyester

Taglia unica | One size | Un tamaño | Taille unique

S41 | TR14 20 x 20 cm 100/400



88017 *maina*

Casacca sportiva. Taglia adulto | Adult sport bib | Dossard, talla grande | Chasuble sportif adulte

Poliestere | Polyester | Poliéster | Polyester

Taglia unica | One size | Un tamaño | Taille unique

S41 | TR14 25 x 25 cm 10/200



95073 *belle*

Corda per saltare | Jumping rope | Comba | Corde à sauter

Plastica | Plastic | Plástico | Plastique

257 cm T5 printing in 2 positions 3 x 1 cm 50/200



41130 qarun

Supporto da braccio per smartphone | Smartphone armband | Brazalete porta moviles | Brassard pour smartphone.

Touch screen / Reflective
Soft Shell | Soft Shell | Soft Shell | Soft Shell

17 x 11 cm S8 | TR1 3 x 1 cm 50 / 200



41776 hjalmar

Fascia da braccio | Armband | Brazalete | Brassard
Soft Shell | Soft Shell | Soft Shell | Soft Shell

7 x 12 cm S8 | TR1 3 x 1 cm 50/200



.05



.01



.08



46087 plutone

Polsiera con scomparto richiudibile | Wristband with pocket | Porta objetos de muñeca | Tour de Poignée
Poliestere 210D | Poliestere 210D | Poliestere 210D | Poliestere 210D

24 x 7 cm S5 | S8 | TR1 7 x 4 cm 1000



41150 fredrick

Polsiera | Wristband | Muñquera | Poignet éponge
Microfibra | Microfiber | Microfiber | Microfibre

10 x 9 cm S8 4 x 4 cm 100/1000



88050 guru

Polsino parasudore | Wrist band | Muñquera | Poignée anti-sueur
Poliestere | Polyester | Poliéster | Poliéster

7 x 7,5 cm S8 | TR1 1 x 1 cm 50/300



.05



.23



65507 gritt

Marsupio multitasche | Waist bag with pockets | Riñonera | Sacoche multipoches

Poliestere 420D | Polyester 420D | Poliéster 420D | Polyester 420D

30,5 x 9,5 x 3,5 cm S8 | TR3 6 x 2 cm 10/300



60082 esperidio

Marsupio con 2 scomparti | Waist bag, 2 compartments | Riñonera con 2 bolsillos | Sac banane avec 2 compartiments
Poliestere 600D | Polyester 600D | Poliéster 600D | Polyester 600D

35 x 15 cm S8 | TR3 | 5 x 3 cm 200



.05



65504 pukila

Marsupio | Waist bag | Riñonera | Poche frontale
Poliestere 600D | Polyester 600D | Poliéster 600D | Polyester 600D

21 x 12 x 5 cm S8 | TR3 5 x 3 cm 90



horel

64170 *horel*

Zaino con tasca frontale | Backpack with front zipped pocket | Mochila con bolsillo frontal | Sac à dos avec poche frontale
 Poliestere 600D | Polyester 600D | Poliéster 600D | Polyester 600D
 27 x 37 x 12 cm 🧺 S78 | SP6 (only for white colour) | TR9 10 x 5 cm 📦 1/50

Breath *and feel it*



64100 *tangerino*

Zaino | Backpack | Mochila | Sac à dos
 Poliestere 600D | Polyester 600D | Poliéster 600D | Polyester 600D
 30 x 40 x 16 cm 🧺 S78 | SP6 (only for white colour) 10 x 10 cm 📦 40



FITNESS Bag

Fitness
648



64049 *palban*

Zaino multitasche con asola per uscita auricolari | Multi-pockets Backpack with earphones opening | Mochila multiusos con agujeros para los auriculares | Sac à dos multipoches avec sortie pour écouteurs
 Poliestere 600D | Polyester 600D | Poliéster 600D | Polyester 600D

45 x 25 x 11 cm ♻️ S78 | TR9 6 x 6 cm 📦 40



64019 *xavier*

Zaino con tasca portatelefonino | Rucksack with reflective spot and front pocket | Mochila, compartimento para móvil y círculo reflectante | Sac à dos avec poche pour téléphone
 Poliestere 600D | Polyester 600D | Poliéster 600D | Polyester 600D

45 x 28 x 14 cm ♻️ S78 | TR9 8 x 8 cm 📦 1/40



64050 *oanez*

Zaino multitasche | Backpack multi-pockets | Mochila multi-bolsillos | Sac à dos, multipoches
 Poliestere 600D | Polyester 600D | Poliéster 600D | Polyester 600D

42 x 25 x 16 cm ♻️ S78 | TR9 10 x 5 cm 📦 15/30



Yes, I'm a multitasking!

64183 *giaglione*

Zaino con tasca frontale | Backpack with front zipped pocket | Mochila con bolsillo frontal | Sac à dos avec poche frontale

Poliestere 600D | Polyester 600D | Poliéster 600D | Polyester 600D

23 x 40 x 12 cm ♻️ S78 | TR9 10 x 10 cm 📦 1/50



.05



.01

.08



64179 *tirana*

Zaino rinforzato sul retro, retine laterali e uscita per auricolari | Backpack with lateral mesh pocket. | Mochila con bolsillos laterales de malla | Sac à dos renforcé avec poches laterales et sortie pour écouteurs

Poliestere 600d | Polyester 600d | Polyester 600d | Polyester 600d

42 x 29 x 11,5 cm | S78 | TR9 10 x 10 cm | 30

fitness
650



.23



.01



.07



.08



.19

64186 *greci*

Zaino con tasca frontale | Backpack with front pocket | Mochila | Sac à dos avec poche frontale

Poliestere | Polyester | Poliéster | Polyester

39 x 28 x 17,5 cm | S78 | TR9 8 x 8 cm | 1/40



greci



64158 *coquet*

Zaino | Backpack | Mochila | Sac à dos
 Poliestere 600D | Polyester 600D | Poliéster 600D | Polyester 600D

43 x 15 x 29 cm 📦 S78 | SP6 (only for white colour) 5 x 5 cm 📦 40



64044 *velle*

Zaino monotasca | Rucksack | Mochila mono bolsillo | Sac à dos avec une poche
 Poliestere 600D | Polyester 600D | Poliéster 600D | Polyester 600D

38 x 26,5 x 14 cm 📦 S78 | TR9 10 x 10 cm 📦 1/50

Fitness
652

64199 *skogaby*

Zaino con 2 grandi scomparti e 3 tasche esterne | Backpack with 2 big compartments and 3 external pockets | Mochila con 2 grandes compartimentos y 3 bolsillos externos | Sac à dos avec 2 grands compartiments et 3 poches externes.

Poliestere 600D | Polyester 600D | Poliéster 600D | Polyester 600D

45 x 30 x 16 cm 📦 S78 5 x 5 cm

📦 40



.23



*Easy
and
practicle*

55791 *skådis*

Sacca-zaino con tasca esterna con cerniera | Backpack with external pocket with zip | Mochila con bolsillo externo con cremallera | Sac avec poche externe avec fermeture éclair
 Poliestere | Polyester | Poliéster | Polyester

42,5 x 40 cm 📦 15 x 10 cm 📦 1/100

FITNESS *Bag*



64198 *skatteby*

Zainetto con tasca esterna frontale e due laterali elasticizzate. Schiena e spalline rinforzate | Kids backpack with animal faces. Models assorted | Mochila para niños con caras de animales. Varios modelos | Sac à dos avec 3 poches élastiques: une frontale et deux laterales, Bretelles et dos renforcés.

Poliestere | Polyester | Poliéstere | Polygester

38 x 21 x 10 cm



60107 *belgrado*

Borsa pieghevole | Foldable bag | Bolsa plegable | Sac pliable
Poliestere 210d | Poliestere 210d | Poliestere 210d | Poliestere 210d

42 x 32,5 x 17 cm S31 4 x 4 cm 50/100



64180 *cacto*

Zaino pieghevole | Foldable backpack with front | Mochila plegable | Sac pliable avec pochette frontale
Ripstop 210D | Ripstop 210D | Ripstop 210D | Ripstop 210D

41,5 x 29,5 x 11 cm S31 6 x 6 cm 50/200

BACKPACK & BAG *foldable*



65126 *trek*

Zaino pieghevole | Foldable backpack with front | Mochila plegable | Sac pliable avec pochette frontale
Ripstop nylon

51 x 27 x 25,5 cm S31 15 x 10 cm 50



65128 dublino

Borsa con dettagli trasparenti. | Transparent Sport Bag |
Bolsa deporte | Sac avec détails transparents.
Plastica, poliester | Plastic, polyester | Plástico, poliéster |
Plastique, polyester

34 x 29 x 20 cm S100 10 x 10 cm 10



64206 chingaza

Zaino trekking con 5 tasche | Trekking backpack with 5 pockets |
Mochila de trekking con 5 bolsillos | Sac à dos trekking avec 5 poches
Nylon 230D | Nylon 230D | Nylon 230D | Nylon 230D

51 x 35 x 13 cm S78 10 x 10 cm 5 / 20

65877 soldat

Camelback | Camelback | Mochila camelback | Sac à dos de chameau
Poliester | Polyester | Poliéster | Polyester

32 x 50 cm S78 | TR9 5 x 5 cm 20



55004 erol

Sacca mare, doppio fondo, tracolla regolabile |
Drawcord bag | Petate con compartimento para
zapatos | Besace de mer, double fond, bandoulière
réglable

Poliester | Polyester | Poliéster | Polyester

50 x Ø 31 cm S78 | TR9 20 x 20 cm

1/30

65021 isidor

Zaino grande a sacca | Drawcord bag | Petate |
Grand sac à dos
Poliester 600D

57 x Ø 33 cm S78 | TR9 20 x 20 cm

1/50

55007 betty

Sacca mare | Drawcord bag | Bolso de playa | Sac de
plage avec coulisse
Cotone | Cotton | Algodón | Coton

43 X Ø 25 cm S78 | TR9 (only for white colour)

| TR9 20 x 20 cm 1/50



64538 miranda

Zaino trekking con 5 tasche | Trekking backpack with 5 pockets |
Mochila d trekking con 5 bolsillos | Sac à dos trekking avec 5 poches
Nylon 230D | Nylon 230D | Nylon 230D | Nylon 230D

51 x 35 x 13 cm S78 10 x 10 cm 5 / 20



65022 *reina*

Borsone sportivo con tascone esterno | Sport bag with external pocket | Bolso deportivo | Grand sac de sport avec grande poche externe
 Poliestere 600D | Polyester 600D | Poliéster 600D | Polyester 600D

45 x 21 x 25 cm | S100 | TR10 15 x 8 cm | 1/50



65050 *ryazan*

Borsone | Holdall | Bolso de viaje | Grand sac
 Poliestere 600D | Polyester 600D | Poliéster 600D | Polyester 600D

52 x 27 x 25 cm | S100 | TR10 15 x 10 cm | 30

65514 *sanning*

Borsone weekend con manici e tasca frontale | Week-end bag with short handles and frontal pocket | Bolsa de fin de semana con asas cortas y bolsillo frontal | Sac weekend avec hanches et poche frontale.

Poliestere | Polyester | Poliéster | Polyester

55 x 30 x 20 cm | S100 8 x 8 cm | 1/20

SHAPE
your life

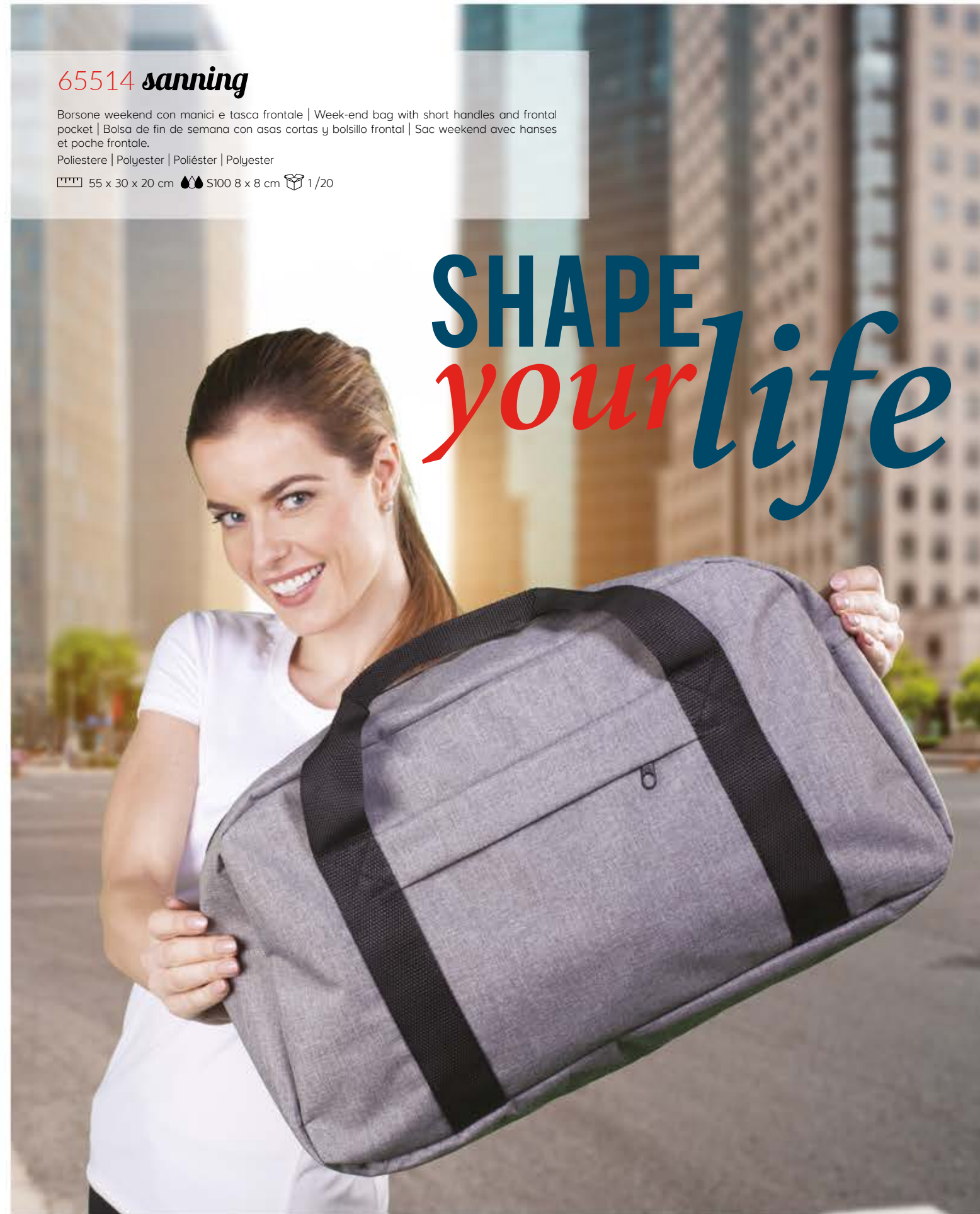

65009 *magnus*

Borsone sportivo, con tracolla | Sport/travel bag with many compartments | Bolso de deporte con 3 bolsillos y bandolera | Grand sac de sport avec bandoulière

Poliestere 600D | Polyester 600D | Poliéster 600D | Polyester 600D

69 x 34 x 36 cm S100 | TR10 20 x 8 cm 1/10



.07

65010 *evelia*

Borsone sportivo, con tracolla | Sport travel bag with shoulder strap and front pocket | Bolso de deporte con bolsillo frontal y bandolera | Grand sac de sport avec bandoulière

Poliestere 600D | Polyester 600D | Poliéster 600D | Polyester 600D

60 x 26 x 35 cm S100 | TR10 15 x 8 cm 1/20



.06

65012 *mariel*

Borsone sportivo, con tracolla | Sport bag with many pockets and shoulder strap | Bolso de deporte con varios compartimientos y bandolera | Grand sac de sport avec bandoulière

Poliestere 600D

59 x 30 x 28 cm S100 | TR10 15 x 8 cm 1/24



.05



64077 *ninke*

Borsone | Holdall | Bolso de viaje | Grand sac de sport
Poliestere 600D | Polyester 600D | Poliéster 600D | Polyester 600D

50 x 38 x 17,5 cm S100 | TR10 15 x 10 cm

20

HOLD ALL



.03



.23



.06



.23



.08

65012 *svalka*

Borsone sportivo | Sport bag | Bolsa de deporte | Sac de sport
Poliestere 600D | Polyester 600D | Poliéster 600D | Polyester 600D

44 x 18 x 25 cm S100 | TR10 15 x 7 cm 40

64099 *nada*

Borsone sportivo | Sport holdall | Bolso de viaje | Grand sac de sport
Poliestere 600D | Polyester 600D | Poliéster 600D | Polyester 600D

62 x 35 x 25 cm S100 | TR10 15 x 8 cm 25



65124 *gissi*

Borsone sportivo, con tracolla | Sport/travel bag with com partments | Bolso deporte con bolsillos y bandolera | Grand sac de sport avec bandoulière
Poliestere 600D | Polyester 600D | Poliéster 600D | Polyester 600D

62 x 28 x 27 cm ♻️ S100 | TR10 15 x 8 cm 📦 1/10



65515 *springa*

Borsa da viaggio con manici corti, tracolla e tasca esterna con velcro | Travel bag with short handles, shoulder belt and pocket with velcro closure | Bolsa de viaje de asas cortas con cinta bandolera y bolsillo con velcro | Sac de voyage avec hanches courtes, bandoulière et poche externe avec velcro
Poliestere | Polyester | Poliéster | Polyester

60 x 30 x 25 cm





.03



.05

64300 *tosterö*

Zaino di jeans | Jeans drawstring bag | Mochila vaquera de cuerdas | Sac à dos en jeans
Poliestere | Polyester | Poliéster | Polyester

34 x 42 cm 576 23 x 25 cm 200



.05



65127 *giffenga*

Borsa sport con tracolla | Travel bag | Mochila de viaje | Sac de sport
Cotone | Cotton | Algodon | Coton

55 x 39 x 23 cm S100 | TR10 15 x 10 cm 1/20



.05

64189 *gosaldo*

Zaino | Drawstring bag | Mochila | Sac à dos avec cordes
Cotone | Cotton | Algodon | Coton

34 x 42 cm S31 15 x 8 cm 20/100

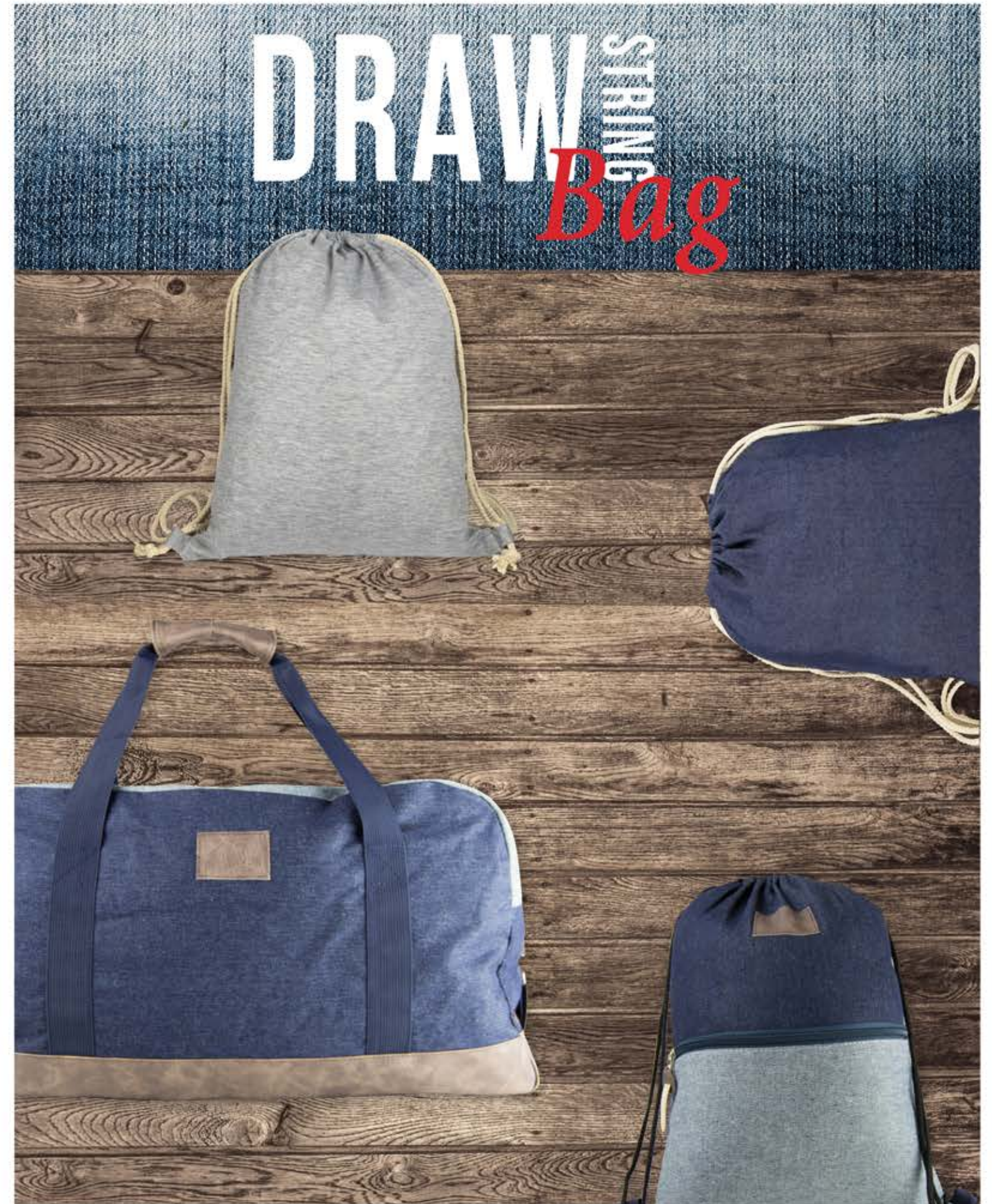

DRAWSTRING BAG



64188 gavorrano

Zainetto con tasca esterna | Drawstring bag with outside pocket. | Mochila con bolsillo externo | Sac à dos avec cordes
Poliestere 210D | Polyester 210D | Poliéster 210D | Polyester 210D

33 x 41,7 cm ●● S76 | SP17 (only for white colour) | TR7 20 x 20 cm 50/200



64080 catalpa

Zaino pieghevole | Foldable bag | Mochila plegable | Sac à dos pliable
Poliestere | Polyester | Poliéster | Poliéster

35 x 34 cm ●● S98 5 x 5 cm 50/200



64007 charo

Zaino, con chiusura a cordino e patella chiusa con velcro | Drawstring bag with velcro | Mochila con solapa y cierre con cinta de velcro | Sac à dos avec coulisse et rabat avec scratch
Nylon 170T

42 x 50 cm ●● S76 | TR7 20 x 20 cm 25/200



64053 mirtel

Zaino con zip e uscita per auricolari | Drawstring bag with zip and earphone holder | Mochila con cremallera y salida para auriculares | Sac à dos avec fermeture éclair et de sortie pour écouteurs
Poliestere 210D | Polyester 210D | Poliéster 210D | Polyester 210D

34 x 43 cm ●● S76 | TR7 15 x 15 cm 10/200



64083 marlise

Zaino | Drawstring bag | Mochila | Sac à dos
Poliestere 190T | Polyester 190T | Poliéster 190T | Polyester 190T

28 x 37 x 9 cm ●● S76 | TR7 20 x 20 cm 20/400



64012 *sten*

Zaino, con bande riflettenti di sicurezza | Drawstring bag with reflective strip | Mochila con banda reflectante | Sac avec bandes réfléchissantes
 Poliestere 190T | Polyester 190T | Poliéster 190T | Polyester 190T

36 x 41 cm S76 | TR7 15 x 15 cm 10/200



64203 *nigeria*

Sacca riflettente | Reflective backpack | Mochila reflectante | Sac a dos reflective
 Poliestere 190 | Polyester 190 | Poliéster 190 | Polyester 190

32 x 42 cm S76 20 x 20 cm 20 / 200



64136 *charmin*

Zaino | Drawstring Bag | Mochila | Sac à dos
 Polyester 210 D | Polyester 210D | Poliéster 210D | Polyester 210T

47 x 38 cm S76 | SP17 (only for white colour) | TR7 15 x 15 cm 20/300



64102 *camden*

Sacca | Ball shaped bag | Bolsa plegable | Sac shopping pliable
 Poliestere 190T | Polyester 190T | Poliéster 190T | Polyester 190T

42 x 42 cm S76 | TR7 15 x 15 cm 50/200



64096 *rolinka*

Zaino | Drawstring bag | Mochila | Sac à dos
 Cotone | Cotton | Algodòn | Coton

38 x 41 cm S76 | TR21 (only for white colour) | TR7 20 x 20 cm 10/100



64085 *maud*

Zaino | Drawstring bag | Mochila | Sac à dos
 Poliestere 190T | Polyester 190T | Poliéster 190T | Polyester 190T

34 x 41 cm S76 (only for white colour) | TR7 15 x 15 cm 10/200



64137 *union*

Zaino con zip e uscita per auricolari | Coloured Pocket drawstring bag and output for headphones | Mochila con bolsillo y salida para auriculares | Sac à dos bicolore et sortie pour écouteurs
 Poliestere 210T | Polyester 210T | Poliéster 210T | Polyester 210T

33 x 42 cm S76 | SP17 (only for white colour) 10 x 10 cm 10/200



65039 *mosca*

Zainetto trasparente | Transparent drawstring Bag | Mochila transparente | Sac à dos transparent
 PVC | PVC | PVC | PVC

34 x 42 cm S97 20 x 20 cm 1/100



.23

**POLYESTER
210**



.18

**NON-WOVEN
TNT**



64093 nella

Zaino | Drawstring backpack | Mochila | Sac à dos
Poliestere 210T | Polyester 210T

33 x 41,7 cm ♻️ S76 | SP17 (only for white colour) | TR7 20 x 20 cm 📦 50/200



64088 gott

Zaino | Drawstring bag | Mochila | Sac à dos avec coulisse
Non-Woven

37 x 40,5 cm ♻️ S76 | TR7 20 x 20 cm 📦 50/200

FITNESS Bag



56107 *gruaro*

Occhiale da sole con protezione UV400 | Sunglasses with UV400 protection | Gafas de sol con protección UV 400 | Lunettes de soleil protection UV400
Plastica | Plastic | Plástico | Plastique

15 x 16,5 x 4 cm T19 | T22 4,5 x 0,7 cm 12/300



.06
SPAIN

.05
FRANCE

.02
ITALY

96145 *carum*

Gessetti per colorare il viso | Cosmetic colours pencils | Ceras para cara | Craies pour coloriage visage
Plastica | Plastic | Plástico | Plastique

6,7 x 1 x 1,7 cm T6 3 x 1 50/300



.02
ITALY



.06

.05

.04

46072 *orid*

Apribottiglia con portachiavi, calciatore | Football player bottle opener with keyring | Abrebotellas con llavero en forma de jugador | Ouvre-bouteille portecclés, joueur
Plastica | Plastic | Plástico | Plastique

8 x 6,5 cm T11 | UV1 8 x 6,5 cm 1/800



.02

50034 *crispini*

Bandiera | Flag | Bandera | Drapeau
Poliestere | Polyester | Polyéster | Polyester

21 x 30 cm S2 8 x 8 cm 50/500



.06

.05

.04



“ Take a look at page 701 ”



.40

50172 *sonni*

Pallone da calcio | Football ball | Balón de fútbol | Ballon de football
PVC

Size 5 T10 3 x 3 cm 1/50

50060 *diego*

Palla da spiaggia gonfiabile | Inflatable football | Pelota de playa con diseño futbol | Ballon de plage gonflable
PVC

empty 25 cm S5 | TR4 12 x 5 cm 100/400

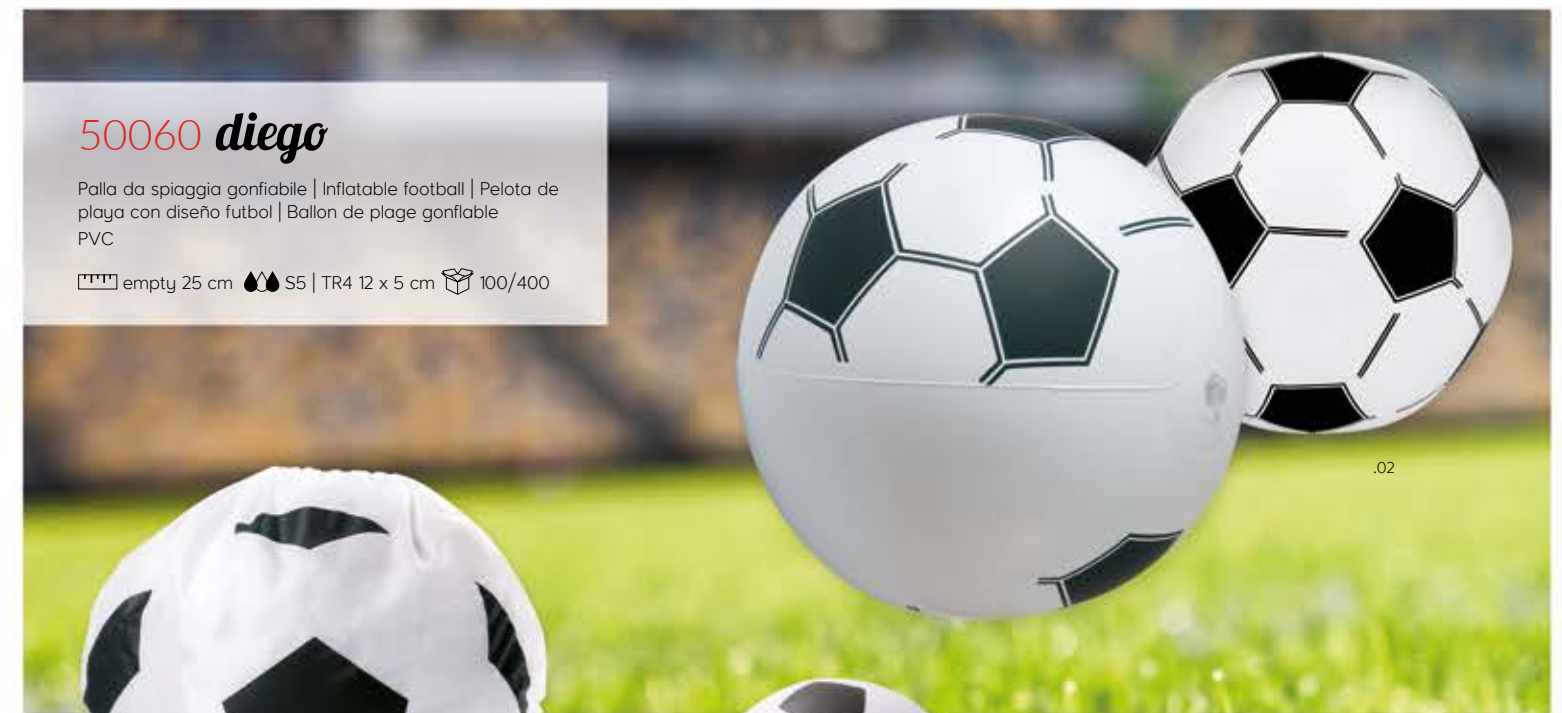

.02



.40



.40



.40

64102 *camden*

Sacca | Ball shaped bag | Bolsa plegable | Sac shopping pliable
Poliestere 190T | Polyester 190T | Polyéster 190T | Polyester 190T

42 x 42 cm S76 | TR7 15 x 15 cm 50/200



.40

29038 *enri*

Antistress a forma di pallone | Football shaped antistress | Antiestrés en forma de bola | Antistress en forme de ballon
PU

Ø 6,3 cm T6 Ø 1 cm 50/200

47201 *jackson*

Portachiavi antistress | Antistress keyring | Llavero antiestrés | Antistress
PU

Ø 4 cm T11 Ø 1,5 cm 200/800



.40



.02

47201 *jackson*

Portachiavi antistress | Antistress keyring | Llavoro antiestrés | Antistress PU

☞ Ø 4 cm ☞ T11 Ø 1,5 cm ☞ 200/800



.02

.06

.08

95536 *sedona*

Pallina da golf | Golf Ball | Bola Golf | Balle de golf
Plastica | Plastic | Plástico | Plastique

☞ Ø 4,2 cm ☞ T6 Ø 1,2 cm ☞ 10/300



.02

95882 *castanar*

Card TEE golf | Golf TEE card | Tarjeta tee golf | Carte tee golf
Plastica | Plastic | Plástico | Plastique

☞ 9,5 x 5 x 0,2 cm ☞ T7 2 x 1 cm ☞ 100 / 1000



.08

.06

.02

.05

95533 *seligman*

Tee per golf | Golf Tee | T Golf | Tee Golf
Plastica | Plastic | Plástico | Plastique

☞ 7 X Ø 1,1 cm ☞ T1 4 x 0,5 cm ☞ 100/1000



.40

91001 *clinton*

Ombrello golf con sistema antivento | Plaid Umbrella | Paraguas cuadros con sistema antiviento | Parapluie Golf
Poliestere | Polyester | Poliéster | Polyester

☞ Ø 135 cm ☞ S33 | SP5 | TR25 (only for white panel) 15 x 10 cm
☞ 10/20



ARE YOU LOOKING FOR A...

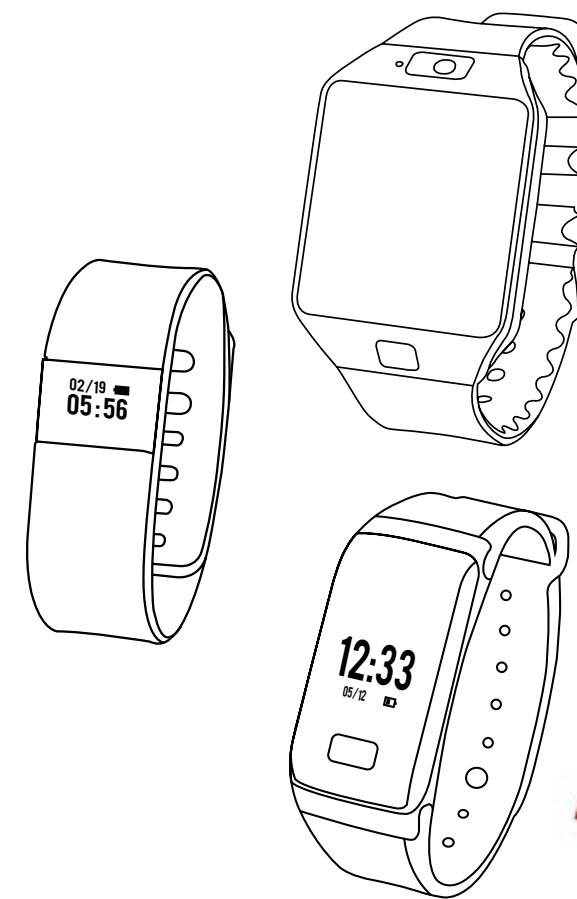

??

“ Take a look at technology chapter ”
pg. 145-147

IMPORT

give life to your **IDEAS:**

Crea la forma, il colore, il materiale, la misura, la grafica e dai vita alla tua idea. Non fermare la tua immaginazione !!

676-689

import

ARE YOU LOOKING FOR A PRODUCT?

NON FERMARE LA TUA IMMAGINAZIONE!
DON'T STOP YOUR IMAGINATION!
NO PARES TU IMAGINACIÓN!
N' ARRÊTES PAS TON IMAGINATION!



Controllo qualità eseguito dal nostro personale
La scelta migliore per le vostre importazioni!

Quality controll made by own employees
The best choice for your imports!

Control de calidad realizado por nuestros
propios empleados
La mejor opción para tus importaciones!

Le contrôle qualité est réalisé par notre personnel
Le meilleur choix pour tes importations !



Neck Warmer

Silicone Bracelet



Scaldacollo | Neck Warmer | Calienta cuellos en poliéster | Tour de Cou
Poliestere | Poliestere | Poliestere | Poliestere

25 x 47 cm 300

SCEGLI COME PERSONALIZZARLO

Disponibile in molte colorazioni
Consegna in 5/20 giorni inclusa di personalizzazione.
Scegli tra stampa, incisione e rilievo

CHOOSE YOUR OWN DESIGN

Available in many colors
Delivery in 5/20 days with logo imprint.
Choose between print, engraving and embossy

CHOISISSEZ COMMENT LE PERSONNALISER

Disponibile en plusieurs couleurs
Livraison en 5/20 jours avec personnalisation.
Choisissez parmi l'impression, gravure et secours

ELIJA LA FORMA DE PERSONALIZAR

Disponibile en muchos colores
Entrega en 5/20 días con personalización.
Elija entre impresión, grabado y alivio

MOQ 100 PCS

Pantone color bracialets on demain



Bracciale in silicone | Silicone bracelet | Pulsera de silicona | Bracelet en silicone
Silicone | Silicone | Silicona | Silicone

Lanyards

Foldable Handfan

import
680



Delivery from **4 days**

Create la **grafica**,
scegliete **misura**
e **modello**

Create your own **graphic**,
choose **size** and **model**

Crea la **gráfica**,
elige **tamaños** y **modelos**

Créez la **personnalisation**,
choisissez la **taille** et le
modèle



safety
clip



metal
hook

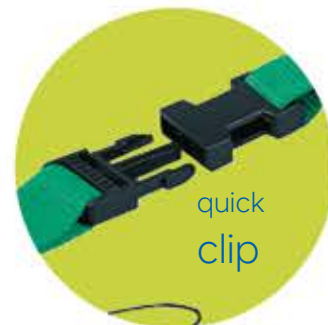

quick
clip



mobile
holder

MOQ 100 PCS



Ventaglio personalizzabile | Customizable fan |
Abanico personalizable | Eventail personnalisable
Plastica | Plastic | Plástico | Plastique

Scegli il colore, scegli la forma e dai vita alla tua idea

Choose the color, choose the form and give life to your ideas

Elija el color, elegir la forma da vida a su idea

Choisir la couleur, choisir la forme et donne vie a votre idee



BAGS

BORSE SHOPPER
SAC BOLSA



PRINT ALL-OVER

SCEGLIETE IL MATERIALE:

tessuto non tessuto laminato, pp, pet cotone, nylon, ecc.
Scegli i colori e i loghi per tutti i lati della borsa.

CHOOSE THE MATERIAL:

laminated non woven, pp woven, pet, cotton, nylon, etc.
Choose colours and logos on all the sides of your bag

ELIGE EL MATERIAL:

tejido laminado (tnt), pp, pet, algodón, nylon, etc
Elige el color de tus acabados marcando tus bolsas por ambos lados

CHOISISSEZ LA MATIERE:

tissu non tissé laminé, pp woven, pet, coton, nylon, etc.
Choisissez les couleurs et le marquage sur toutes les faces du sac.

BAMBAM

PRINTING ALL-OVER starting from 1000set

Stick



BAM BAM Stick (2 pcs)
PVC
10 x 60 cm



Salvietta per occhiali personalizzata in quadricromia | Cleaning cloth for glasses with 4col imprint | Toallita limpia gafas con logotipo en quadricromia | Serviette pour lunettes personnalisée 4 col. Microfibra | Microfiber | Microfibra | Microfibre

13 x 18 cm 100/1000

Cleaning cloth for glasses

MOUSEPAD



Tappetino mouse | Mousepad | Alfombrilla | Tapis de souris
any size and material



Tailored Peluches

Scegli il colore, scegli la forma e dai vita alla tua idea

Choose the color, choose the form and give life to your ideas

Elija el color, elegir la forma da vida a su idea

Choisir la couleur, choisir la forme et donne vie a votre idee

MOQ 500 PCS

DITE ADDIO ALLE IMPRONTE SULLO SCHERMO!
Pratico, pulito, comodo, sempre con te.

Scegli forma e dimensione!

SAY GOODBYE TO FINGERPRINTS ON THE SCREEN!
Practical, clean, convenient, always with you.

Choose shape and size!

STICKSCREEN CLEANER

StickScreen Cleaner con retro adesivo, personalizzato in quadricromia | StickScreen Cleaner, full colour print on one side | StickScreen Cleaner con adhesivo, personalización en cuatricromia | StickScreen Cleaner avec rétro autocollant personnalisé en quadrichromie

Possibile packaging con biglietto da visita | Available packaging with business card | Posibilidad de packing personalizado con tarjeta de visita | Possible packaging avec carte de visite

Poliestere | Polyester | Poliéster | Polyester

MOQ: 500pcs

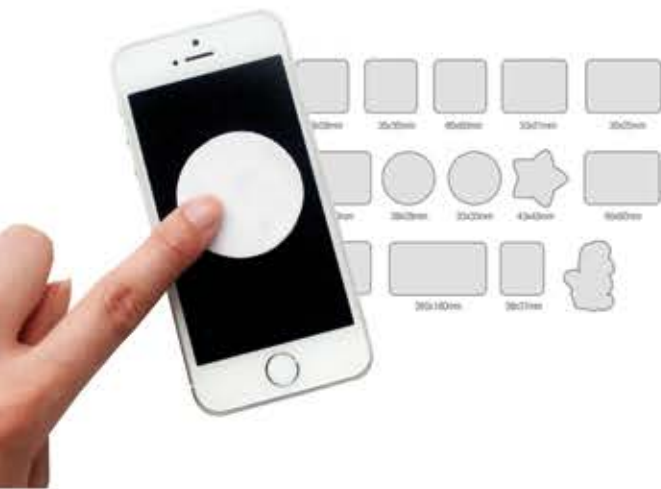

PERSONALIZED PACKING

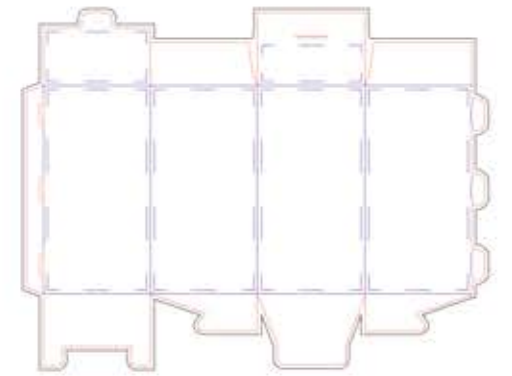

PERSOPACKING è un'idea innovativa dove si ha la possibilità di avere una personalizzazione a 360° dall'articolo alla scatola con logo, testi o immagini per ogni tipologia ed evenienza!

Utilizza la tua creatività e crea scatole uniche capaci di attirare i tuoi clienti o sbalordire gli invitati in tutti gli avvenimenti speciali.

Personalizza la tua scatola e rendila originale e speciale!

PERSOPACKING it's an innovative idea to fully personalize the box with your logo, text or images, for every type and circumstances

Create the most original boxes for your clients, your events or special occasions. Make your packaging original and unique.

Add a special touch to your packaging!

PERSOPACKING es una idea innovativa que te ofrece la posibilidad de realizar una personalización completa del producto de acuerdo a tus necesidades. Podrás personalizar desde el artículo hasta seleccionar el packing mas conveniente personalizándolo con logos, textos o imágenes.

Crea las cajas más originales para entregar a tus clientes, para tus eventos o para ocasiones especiales en las que quieras regalar una caja original y única.

¡Da un toque especial a tu caja personalizada!

PERSOPACKING est une idée innovative qui vous permet de faire une personnalisation à 360° du produit à la boîte avec logo, texte ou images de tout type et pour chaque circonstance.

Créez des boîtes à remettre à vos clients, pour vos événements ou pour un cadeau spécial dans une boîte originale et unique.

Donnez une touche d'originalité à vos boîtes personnalisées !





Crea il tuo stile
Create your own style
 Crea tu estilo
Créez votre style



Portachiavi realizzato su disegno 2d e 3d. Minimo 500 pz. | Customized keyring made by 2d and 3d layout MOQ: 500 units. | Llavero hecho a medida con diseño 2d y 3d. Cantidad minima 500 uds | Porte-cles sur design 2d et 3d. moq:500 pcs
 Soft pvc



**USBDRIVE &
 POWERBANK**

Starting from 50 pcs

La tua connessione con l'Asia | Your connection with Asia
 Votre connection avec l'Asie | Tu conexión con Asia



I marchi menzionati in questo catalogo sono di proprietà esclusiva dei rispettivi proprietari. Il loro utilizzo è a puro titolo esemplificativo. I suddetti marchi non potranno mai, in alcun caso, essere oggetto di trattative commerciali.
 The brands mentioned in this catalogue are protected by copyright from the owners. They can not be subjected to any comercial negotiation.
 Las marcas mencionadas en este catálogo son de propiedad exclusiva de los dueños. Estas marcas no podrán nunca ser objeto de negociaciones comerciales.
 Les logos utilisés dans ce catalogue sont de propriété exclusive des respectifs propriétaires. Leur utilisation est à titre d'exemple, donc ils ne pourront jamais être objet de négociations commerciales.



BALLONS

MOQ 1000 PCS



GETC-3
Compressore elettrico
Electric air compressor
Compreso electrico
Compresseur à air électrique



GETP-2
Pompa per gonfiaggio
Air compressor
Bomba por hinchar
Compresseur à air



GETA-4
Astina con valvole
Little bat with valve
Asta con valvola
Tige avec vanne



GETP-1
Pompa per gonfiaggio
Air compressor
Bomba por hinchar
Compresseur à air



GETF-5
Filo
Wire
Alambre
Fil



Palloncino disponibile in 150 colorazioni, con stampa fino a 6 colori / Balloon available in 150 colors. With prinwork up to 6 colors / Globos disponible en 150 colores. con impresion hasta 6 colores / Ballons de baudruche disponibles en plus de 150 couleurs avec marquage jusqu'à 6 couleurs

Ø 32 cm

STAMPA IL TUO LOGO
PRINT YOUR LOGO
GRABA TU LOGO
IMPRIMES TON LOGO

Stampa fino a 6 colori, da 1 lato a tutto il globo!
Print until 6 colours, from 1 side until the entire globe!
Impresion hasta 6 colores, desde 1 cara hasta todo el globo!
Personnalisation de 1 à 6 couleurs avec marquage de un côté jusqu'à la totalité de la circonference du ballon!



JT0680



JB9481

THE GIFT
collection



JB9493



JB9422



XT0620



JF9791



JR9190

BB
BALENCIAGA

ICEBERG

Gattinoni

Renato Balestra

BB BELFE

Mascalzone Latino



HB0495



JB9460



JB9421



JR9192



HF0740

Prodotti disponibili fino ad esaurimento scorte. Products available until end of stock.



**request
our
textile
catalogue**

Accendini	202
Accessori da golf	674
Accessori da viaggio	502,505-513
Accessori per auto, bicicletta	618-621,627,642
Accessori per la scuola	538,54
Accessori sportivi	644
Adattatore da viaggio	109,510,511
Antistress	298-303
Apribottiglia	158,160,166
Articoli per tifoseria	672
Asciugamano da spiaggia	396-399,639-641
Astucci per penne	62, 63
Auricolari	120-127
Barbecue	584,585
Batteria portatile	91
Bicchiere	184,185,201,565,570,571,574-579
Binocoli, bussole	587
Block notes	346-363,424,429,430,432-436
Block notes con memo stick	370,371,435-438
Block-notes, moleschino, memo adesivi	346-363
Borracce	576,580-583,631-637
Borsa biodegradabile	446
Borsa in carta	455
Borsa in cotone	456-462,464,465,472
Borsa in feltro	473
Borsa in juta	451,460,462-464,469
Borsa in poliestere	450,452-454,466-468,472
Borsa in TNT	441-445,447,449,451
Borsa per bottiglia	164-168
Borsa portadocumenti	473-480,490,491
Borsa sportiva con trolley	494
Borse da spiaggia	400
Borse sportive e accessori	493,658-664
Borse termiche e accessori	401-405,407
Borsoni da viaggio	496-501,503
Bracciale con USB	118
Braccialetti	316, 317,388
Calcolatrici	82-85,332
Campeggio	583
Candela	204,205
Cani (accessori)	589-593
Cappellini	319-326,329
Caramelle scatole	199.
Caricabatterie per auto	112,113
Caricatore USB	117
Caricatore wireless	96
Cartelle e borse porta documenti	332
Casacche sportive	643
Cassa audio	128-131
Cavaturaccioli	160,161
Cavo USB	117,118
Cottellini	600-603

Coltello da cucina	155,181,183
Contapassi, cronometri	630
Contenitore per alimenti	180
Cravatta	266
Cucchiaino da cucina	154
Cuffie	127
Cuffie da piscina	389
Custodia per cellulare	137
Cutter	605
Deodorante ambiente	206,207
Dosa spaghetti	198
Edilizia (accessori)	604,61
Evidenziatori	35-40
Flash per cellulare	111
Flessometri, metri	610-615
Frisbee	384
Frullatore	195
Gamepad	88
Giochi per adulti	586
Giochi per bambini	536,542-544,556-563,642
Giubbotti, gilet d'emergenza, art. fluorescenti	622-625
Gomme	534,535
Gonfiabili	410-413,416
Grembiuli	169-175
Guanti	328,329
Guanti da cucina	176-178
Guanti da giardinaggio	603
Guanti touchscreen	109
HUB	102,105,111,134
Impermeabili	230-233
Infradito	417
Insalatiera	150
Lampada da lettura	110
Lampada led	115
Lampade da lettura e segnalibro	110,364
Lanyard	312-315
Lavagnetta	119
Lente d'ingrandimento	144
Lente ottica	197
Lettore Smart card	645
Lost & found	516-524
Macina pepe	32, 33, 39
Marsupi	304-311
Matite	198
Matite da ufficio	132,133
Medical	373-381
Molletta	88
Mouse	216-220,223-227,229
Occhiali da sole e accessori	219
Occhiali virtuali	
Ombrello automatico	
Ombrello bimbo	

Ombrello manuale	221,225,228
Ombrello pieghevole	210-215
Ombrellone	392
Orologi da muro	74,76,
Orologi da polso	83,145,147
Orologi da tavolo, sveglie e termometri	73,77-81,134
Oscurante per webcam	106
Padella	181
Palloncini da spiaggia e da calcio	382,383,414,416,673
Peluches	548-551
Penna a sfera Touch screen	32, 41-53, 64, 71
Penna per bambino	532
Penna roller	54-57
Penne astucciate / paroure	54-57, 66, 67, 71
Penne in legno / ecologiche	64-71
Penne in metallo	9, 58-61
Penne in plastica	3, 4, 5, 6-9
Penne multi-refil	25, 29, 31, 46
Penne multifunzioni	26-28, 30, 31
Pennelli trucco	250,251
Plaid in pile	566-569
Pochette	235-247,389
Poggiaborse	267
Porta badge	312,317
Porta CD	369
Porta cellulare	268,269,616,617
Porta USB	103
Portablocco	335-343,345,423
Portablocco con USB	107
Portabottiglia termico	406
Portacarte di credito	270-272,332,333
Portachampagne	162
Portachiavi con luce	287
Portachiavi in metallo e in legno	280,282,288-290-292-297
Portachiavi in plastica, similpelle, peluche	279-283,284,285
Portachiavi multifunzione	277--280,283-286
Portadocumenti	106,334-338,344
Portafoto	203,552,553
Portamenù	98
Portamonete	273-277
Portanome	507
Posacenere	202,39
Power bank	90-101,
Presine	176
Puliscischermo	108,136
Puntatore laser	119
Puntatore touch screen	136,142
Racchette da spiaggia	385
Radio	84
Righelli	366,367,431,520,521
Righelli con calcolatrice	85
Salvadanaio	556

Indice alfabetico

Scalda tazze	119
Sciarpe	266,267,328
Sedie da spiaggia	386,387
Selfie stick	138,139
Set bagno	261-263
Set da disegno	525-531
Set manicure	248,249
Set Vino	156-159
Shaker	200,637
Sombrero	418-421
Sottobicchiere	168,194
Spazzola	254,255
Spazzolino da denti	258-260,541
Specchietto	252-254
Stilofori	27, 28
Stuoia da mare	393-395
Supporto per cellulare	104,105, 135
Taccuino	424,429,430,432-436
Tagliapizza	182
Taglieri	151-153
Tappetini mouse, mouse	116
Tappo per bottiglia	167
Tastiera	135
Tazza	186-193
Tazza per bambini	554,555
Tazzina da caffè	195
Telecamera WI-FI	114,115
Temperini	524,525,533,534
Thermos	565,572,573
Timer	196
Torcia e batterie	129,595,603,606-609,617
Tovaglietta	178
USB	103,111,140,141,143,144
Utensili	596-599
Vasi con sementi	427
Vaso speaker	87
Vassoio	150
Ventaglio	390,391
Ventilatore	104,408
Videocamera	89
Zaino	484-489,492
Zaino con trolley	494,495
Zaino da bambini	545-547
Zaino sportivo	629,646-657,664-670

Accessories for car, bicycle	618-621,627,642
Air freshener	206,207
Antistress	298-303
Aprons	169-175
Articles for supporters	672
Ashtrays	202,39
Automatic umbrella	216-220,223-227,229
Backpack	484-489,492
Backpack with trolley	494,495
Badge holder	312,317
Bag rack	267
Ball pen with different colors	25, 29, 31, 46
Ball pen with touch screen	32, 41-53, 64, 71
BBQ	584,585
Beach bags	400
Beach balls	382,383,414,416,673
Beach chairs	386,387
Beach rackets	385
Beach towels	396-399,639-641
Beach umbrella	392
Beauty case	235-247,389
Binoculars, compasses	587
Bio bag	446
Blackboard	194
Block notes	346-363,424,429,430,432-436
Bot	406
Bottle bag	164-168
Bottle cap	167
Bottle opener	158,160,166
Bracelet with USB	118
Bracelets	316, 317,388
Brush	254,255
Building (accessories)	604,61
Calculator with ruler	85
Calculators	82-85,332
Camera	89
Camping	583
Candies with box	199.
Candle	204,205
Caps	319-326,329
Car charger	112,113
Cases - Boxes	62, 63
Cd holder	369
Champagne bowl	162
Chopping boards	151-153
Clothespin	198
Coaster	168,194
Cofee mug	195
Conference folder	335-343,345,423
Cooking pan	181
Cooler bags and accessories	401-405,407
Cooling fan	104,408

Corkscrew	160,161
Cotton bag	456-462,464,465,472
Credit card holder	270-272,332,333
Cup warmers	119
Cutters	605
Darkening for webcam	106
Desk clock, alarm clocks and thermometers	73,77-81,134
Document bag	473-480,490,491
Document folder and briefcases	332
Document holder	106,334-338,344
Dog (accessories)	589-593
Drawing set	525-531
Drinking bottle	576,580-583,631-637
Earphone	120-127
Earphone	127
Fan	390,391
Felt bag	473
Flashlight and batteries	129,595,603,606-609,617
Fleece plaids	566-569
Flip flop	417
Foldable umbrella	210-215
Folder with usb	107
Food container	180
Freesby	384
Gamepad	88
Games for adults	586
Garden glove	603
Glasses	184,185,201,565,570,571,574-579
Gloves	328,329
Golf accessories	674
Highlighters	35-40
Hub usb	102,105,111,134
Inflatable items	410-413,416
Keyboard	135
Keyring with light	287
Keyrings in plastic,PU,plush	279-283,284,285
Kids backpack	545-547
Kids game	536,542-544,556-563,642
Kids mug	554,555
Kids pen	532
Kids umbrella	219
Kitchen gloves	176-178
Kitchen spoon	154
Knife	155,181,183
Knives	600-603
Lanyard	312-315
Laser pointer	119
Led light	115
Lighters	202
Lost & found	144
Luggage tag	507
Magnifying glass	617

Makeup brushes	250,251
Manicure set	248,249
Manual umbrella	221,225,228
Measuring tapes, meters	610-615
Medical	304-311
Menu holder	98
Metal pens	9, 58-61
Mirror	252-254
Mixer	195
Mobile phone flash	111
Mobile phone holders	137
Mobile phone holders	268,269,616,617
Mobile phone support	104,105, 135
Money box	556
Monitor cleaner	108,136
Mouse	132,133
Mouse pads, mouse	116
Mug	186-193
Multifunction pens	26-28, 30, 31
Multifunctional keyrings	277--280,283-286
Notepad	424,429,430,432-436
Notepad, moleskine, sticky notes	346-363
Notepads with memo sticks	370,371,435-438
Office pencil	32, 33, 39
Optical lens	131
Paper bag	455
Pedometers, chronometers	630
Pencils	516-524
Penholder	27, 28
Pens in plastic	3, 4, 5, 6-9
Pens with box/ paroure	54-57, 66, 67, 71
Pepper mill	197
Photo frames	203,552,553
Pizza cutter	182
Placemats	178
Plug adapter	109,510,511
Plush toys	548-551
Poliestere bag	450,452-454,466-468,472
Pot speaker	87
Potholders	176
Power bank	91
Power bank	90-101,
Purses	273-277
Radio	84
Rain jackets	230-233
Reading lamp	110
Reading lamps, bookmarks	110,364
Roller pen	54-57
Rubber	534,535
Rulers	366,367,431,520,521
Salad bowl	150
Scarves	266,267,328

Alphabetical index

School accessories	538,54
Sea mat	393-395
Selfie stick	138,139
Shaker	200,637
Sharpener	524525,533,534
Smart card reader	119
Sombrero	418-421
Spaghetti dispenser	198
Speaker	128-131
Sport accessories	644
Sport backpack	629,646-657,664-670
Sport bag and accessories	493,658-664
Sports bag with trolley	494
Sports jackets	643
Sunglasses and accessories	373-381
Swimming cap	389
Thermos	565,572,573
Ties	266
Timer	196
TNT bag	441-445,447,449,451
Toilet set	261-263
Tools	596-599
Toothbrush	258-260,541
Touch glove	109
Touch screen pointer	136,142
Travel accessories	502,505-513
Travel bags	496-501,503
Tray	150
Usb	103,111,140,141,143,144
Usb cable	117,118
Usb charger	117
Usb holder	103
Vase with flower seeds	427
Vests, vests emergency, fluorescent item	622-625
VR glass	88
Waist bag	645
Wall clocks	74,76,
Wifi camera	114,115
Wine set	156-159
Wireless charger	96
Wooden and metal keyrings	280,282,288-290-292-297
Wooden pens / ecological	64-71
Wrist watches	83,145,147
Yuta bag	451,460,462-464,469

Abrebotellas	158,160,166
Accesorios de escuela	538,54
Accesorios de golf	674
Accesorios de viaje	502,505-513
Accesorios deportivo	644
Accesorios para el coche, bicicleta	618-621,627,642
Adaptador de viaje	109,510,511
Agarraderas	176
Albanico	390,391
Alfombrillas de ratón, ratón	116
Altavoz	128-131
Ambientador	206,207
Antiestrés	298-303
Apagón de webcam	106
Artículos hinchables	410-413,416
Artículos para partidarios	672
Auriculares	120-127
Balones de playa	382,383414,416,673
Bandeja	150
Barbacoa	584,585
Bidon	576,580-583,631-637
Binoculares, brújulas	587
Block notes	346-363,424,429,430,432-436
Block notes	424,429,430,432-436
Block notes con memo stick	370,371,435-438
Blocs de notas, moleskine,memos adhesivos	346-363
Boligrafo	27, 28
Bolígrafo de pantalla táctil	32, 41-53, 64, 71
Boligrafo de plastico	3, 4, 5, 6-9
Boligrafo multi-tinta	25, 29, 31, 46
Bolígrafo para niño	532
Boligrafo roller	54-57
Bolígrafos con la caja / paroure	54-57, 66, 67, 71
Boligrafos de madera / ecológico	64-71
Boligrafos de metal	9, 58-61
Bolígrafos multifunción	26-28, 30, 31
Bolsa biodegradable	446
Bolsa de algodón	456-462,464,465,472
Bolsa de documentos	473-480,490,491
Bolsa de feltro	473
Bolsa de papel	455
Bolsa de poliester	450,452-454,466-468,472
Bolsa de TNT No Woven	441-445,447,449,451
Bolsa de yuta	451,460,462-464,469
Bolsa deportiva con carro	494
Bolsa por botellas	164-168
Bolsas de playa	400
Bolsas de viaje	496-501,503
Bolsas térmicas y accesorios	401-405,407
Bolso de deporte y accesorios	493,658-664
Bowl de champagne	162
Bufandas	266,267,328

Cable USB	117,118
Cacerola	181
Caja de dinero	556
Cajas de cartón	62, 63
Calculadoras	82-85,332
Calentadores de taza	119
Cámara	89
Cámara WI-FI	114,115
Camping	583
Caramelos con caja	199.
Cargador de coche	112,113
Cargador USB	117
Cargador Wireless	96
Carpeta	335-343,345,423
Carpeta con USB	107
Carpeta por Menu	98
Carpetas y bolsas portadocumentos	332
Carteras	273-277
Casco	127
CD titular	369
Ceniceros	202,39
Cepillo	254,255
Cepillo de dientes	258-260,541
Chalecos, chalecos de emergencia, articulo fluorescente	622-625
Chanclas	417
Chaquetas deportivas	643
Coaster	168,194
Conjunto de manicura	248,249
Contenedor alimentar	180
Corbatas	266
Cortadore de pizza	182
Cremallera del bolso	267
Cuchara de cocina	154
Cuchillo de cocina	155,181,183
Cuchillos	600-603
Cutters	605
Delantales	169-175
Dispensador de espaguetti	198
Edificio (accesorios)	604,61
Encendedores	202
Ensaladera	150
Espejo	252-254
Estera de mar	393-395
Estuche térmico para botella	406
Flash para dispositivos móviles	111
Florero altavoz	87
Frisbee	384
Funda para movil	137
Gafas de sol y accesorios	373-381
Gafas VR	88
Gamepad	88
Goma	534,535

Gorras	319-326,329
Gorro de baño	389
Guantes	328,329
Guantes de cocina	176-178
Guantes de jardinería	603
Guantes touch	109
Herramientas	596-599
Hub	102,105,111,134
Identificador de equipaje	507
Impermeables	230-233
Juegos para adultos	586
Juegos para niños	536,542-544,556-563,642
Lámpara de lectura	110
Lámpara LED	115
Lámparas de lectura y señalalibros	110,364
Lanyard	312-315
Lápices	516-524
Lápices de oficina	32, 33, 39
Lector de Smart card	119
Lente óptica	131
Limpiador de pantalla	108,136
Linterna y pilas	129,595,603,606-609,617
Llavero con luz	287
Llaveros de madera y metal	280,282,288-290-292-297
Llaveros de plástico,polipiel,pluche	279-283,284,285
Llaveros multifunciones	277--280,283-286
Lost & found	144
Lupa	617
Maletine	106,334-338,344
Mantas polares	566-569
Manteles individuales	178
Marcadores	35-40
Medical	304-311
Metros flexibles,metros	610-615
Mezclador	195
Mochilla	484-489,492
Mochilla con trolley	494,495
Mochilla deportiva	629,646-657,664-670
Mochilla para niños	545-547
Molinillo de pimienta	197
Monopod	138,139
Neceser	235-247,389
Palas de playa	385
Paraguas automático	216-220,223-227,229
Paraguas manual	221,225,228
Paraguas niños	219
Paraguas plegable	210-215
Peluches	548-551
Perro(accesorios)	589-593
Pinceles de maquillaje	250,251
Pinza	198
Pizarra	194

Indice alfabético

Podómetros, cronómetros	630
Porta móviles	268,269,616,617
Portabadge	312,317
Portafotos	203,552,553
Power bank	91
Power bank	90-101,
Puerto USB	103
Pulsera USB	118
Pulseras	316, 317,388
Puntero de pantalla táctil	136,142
Puntero láser	119
Radios	84
Raton	132,133
Reglas	366,367,431,520,521
Reglas con calculadora	85
Relojes de mesa, despertadores y termómetros	73,77-81,134
Relojes de pared	74,76,
Relojes de pulsera	83,145,147
Rinonera	645
Sacacorchos	160,161
Secapuntas	524525,533,534
Set de baño	261-263
Set de dibujo	525-531
Set de vino	156-159
Shaker	200,637
Sillas de playa	386,387
Sombrero	418-421
Sombrilla de playa	392
Soporte de teléfono móvil	104,105, 135
Tablas de cortar	151-153
Tapa de botella	167
Taza	186-193
Taza de café	195
Taza para niños	554,555
Teclado	135
Temporizadores	196
Termos	565,572,573
Titular de la tarjeta de crédito	270-272,332,333
Toallas de playa	396-399,639-641
USB	103,111,140,141,143,144
Vaso	184,185,201,565,570,571,574-579
Vasos con semillas	427
Vela	204,205
Ventilador	104,408

Accessoires bricolage	604,61
Accessoires de golf	674
Accessoires pour l'école	538,54
Accessoires voiture, vélo	618-621,627,642
Adaptateur de voyage	109,510,511
Antistress	298-303
Articles pour les supporters	672
Assombrir pour webcam	106
Ballons gonflables de plage	382,383414,416,673
Barbecue	584,585
Batterie portable	91
Bloc-notes, moleskine, mémo adhésifs	346-363
Block notes	346-363,424,429,430,432-436
Block notes avec sticky notes	370,371,435-438
Boîte de conservation alimentaire	180
Bonbons dans la boîte	199.
Bonnet de bain	389
Bouchon pour bouteille	167
Bougie	204,205
Bracelet avec Usb	118
Bracelets	316, 317,388
Briquets	202
Brosse à dent	258-260,541
Câble Usb	117,118
Cadre photos	203,552,553
Calculettes	82-85,332
Calepin	424,429,430,432-436
Camera Wifi	114,115
Camping	583
Casque audio	127
Casquettes	319-326,329
Cendriers	202,39
Chaise de plage	386,387
Chargeur pour voiture	112,113
Chargeur sans fil	96
Chargeur Usb	117
Chasuble sportif	643
Chauffe tasse	119
Chien(accessoires)	589-593
Clavier	135
Conférencier	106,334-338,344
Coupe pizza	182
Couteau cuisine	155,181,183
Couteaux	600-603
Cravates	266
Crayons	32, 33, 39
Crayons	516-524
Cuillère de cuisine	154
Cutters	605
Diffuseur de parfum d'ambiance	206,207
Doseur spaghetti	198
Écharpes	266,267,328

Ecouteurs	120-127
Étiquette pour bagage	507
Étui pour portable	137
Étuis - Boites	62, 63
éventail	390,391
Flash pour téléphone portable	111
Frisbee	384
Gants	328,329
Gants de cuisine	176-178
Gants pour jardinage	603
Gants tactiles	109
Gilets, gilets urgence, articles fluorescent	622-625
Gomme,	534,535
Gourdes	576,580-583,631-637
Haut parleur	128-131
Horloges	74,76,
Horloges de table, réveils et termomètres	73,77-81,134
Hub usb	102,105,111,134
Imperméables	230-233
Jeux pour adultes	586
Jeux pour enfants	536,542-544,556-563,642
Jumelles, podomètres, chronomètres	587
Kit de sport	644
Kit de voyage	502,505-513
Lampe à Led	115
Lampe de lecture	110
Lampes de lecture et marque-pages	110,364
Lanyard	312-315
Lecteur smartcard	119
Lentille optique	131
Lost & found	144
Loupe	617
Lunettes de soleil et accessoires	373-381
Lunettes virtuelles	88
Manette de jeux	88
Maniques	176
Medecin	304-311
Mètres flexibles, mètres	610-615
Minuteur	196
Miroir	252-254
Mixeur	195
Montres	83,145,147
Moulin à poivre	197
Napperon	178
Natte de plage	393-395
Nettoyeur d'Écran	108,136
Objets gonflables	410-413,416
Outils	596-599
Parapluie automatique	216-220,223-227,229
Parapluie manuelle	221,225,228
Parapluie pliant	210-215
Parapluie pour enfant	219

Parasols	392
Peluches	548-551
Perche à selfie	138,139
Piceaux pour maquillage	250,251
Pince à linge	198
Pinceau	254,255
Plaid en laine polaire	566-569
Planches à découper	151-153
Plateau	150
Pochette	235-247,389
Pochettes et sacs porte-documents	332
Podomètres, chronomètres	630
Poêle	181
Pointeur laser.	119
Port clef avec lumière	287
Porte Badge	312,317
Porte bloc	335-343,345,423
Porte carte de credit	270-272,332,333
Porte Cd	369
Porte documents avec USB	107
Porte menu	98
Porte usb	103
Porte-cellulaires	268,269,616,617
Porte-monnaie	273-277
Porte-plume	27, 28
Porteclés en métal et en bois	280,282,288-290-292-297
Porteclés en plastique, PU, peluche	279-283,284,285
Porteclés multifonctions	277--280,283-286
Pot aver haut parleur	87
Power bank	90-101,
Radios	84
Raquettes de plage	385
regle avec calculatrice	85
Règles	366,367,431,520,521
Sac à dos	484-489,492
Sac à dos avec roulettes	494,495
Sac à dos pour enfant	545-547
Sac à dos sport	629,646-657,664-670
Sac biodégradable	446
Sac crémaillère	267
Sac de sport à roulette	494
Sac de sport et accessoires	493,658-664
Sac en coton	456-462,464,465,472
Sac en feutrine	473
Sac en Jute	451,460,462-464,469
Sac en papier	455
Sac en Polyester	450,452-454,466-468,472
Sac porte bouteille	164-168
Sac Porte bouteille isotherme	406
Sac porte champagne	162
Sac porte documents	473-480,490,491
Sac shopping pas tissé	441-445,447,449,451

Index alphabétique

Sacoches multipoches	645
Sacs de plage	400
Sacs de voyag	496-501,503
Sacs thermiques et accessoires	401-405,407
Saladier	150
Serviettes de bain	396-399,639-641
Set de bain	261-263
Set de dessin	525-531
Set de vin	156-159
Set pour manucure	248,249
Shaker	200,637
Sombrero	418-421
Souris pour ordinateur	132,133
Sous verre	168,194
Stylo à bille avec clip, avec plusieurs couleurs	25, 29, 31, 46
Stylo bille avec stylet et support pour portable	32, 41-53, 64, 71
Stylo pour enfants	532
Stylo roller	54-57
Stylos avec boîte/paroure	54-57, 66, 67, 71
Stylos en bois / écologique	64-71
Stylos en métal	9, 58-61
Stylos en plastique	3, 4, 5, 6-9
Stylos multifonctions	26-28, 30, 31
Support pour portable	104,105, 135
Surligneurs	35-40
Tableau noir	194
Tabliers	169-175
Taille-crayons	524525,533,534
Tapis pour souris, souris	116
Tasse	186-193
Tasse à cafe	195
Tasse pour enfants	554,555
Thermos	565,572,573
Tire-bouchon	158,160,166
Tire-bouchon	160,161
Tirelire	556
Tongs de plage	417
Torche et batterie	129,595,603,606-609,617
Touch Screen Pointer	136,142
Usb	103,111,140,141,143,144
Vases avec semances	427
Ventilateur	104,408
Verre	184,185,201,565,570,571,574-579
Vidéo ca mera	89